

**SIDE**



ESTETICA ESCLUSIVA DATA DALLE GEOMETRIE PURE DELLE MANIGLIE IN ALLUMINIO CHE POSSONO ESSERE APPLICATE AL CENTRO O ALL'ESTREMITÀ DEI FRONTALI. DISPONIBILE TRASVERSALMENTE IN TUTTE LE FINITURE DELLA GAMMA **ARCHEDA**. UN PROGETTO CARATTERIZZATO DA SEMPLICITÀ E RIGORE; UN INSIEME DI PROPOSTE FLESSIBILI, CAPACI DI SUGGERIRE FUNZIONALITÀ ED ESTETICA AL TEMPO STESSO.

# SIDE

EXCLUSIVE AESTHETICS HAVE BEEN CREATED WITH SLICK GEOMETRIC ALUMINIUM HANDLES, WHICH CAN BE APPLIED IN THE MIDDLE OR AT THE END OF THE FRONTS. THIS VERSATILE FEATURE IS AVAILABLE IN ALL FINISHES IN THE **ARCHEDA** RANGE. THIS DESIGN PROJECT IS SIMPLE AND PRECISE, BRINGING TOGETHER A SELECTION OF FLEXIBLE PRODUCT IDEAS THAT LOOK GREAT BUT ARE ALSO PRACTICAL.

EXKLUSIVE ÄSTHETIK DURCH DIE REINE GEOMETRIE DER ALUMINIUMGRIFFE, DIE IN DER MITTE ODER AM ENDE DER FRONTEN ANGEBRACHT WERDEN KÖNNEN. ERHÄLTICH IN ALLEN AUSFÜHRUNGEN DER REIHE **ARCHEDA**. EINE KOLLEKTION, DIE SICH DURCH EINFACHHEIT UND STRENGE AUSZEICHNET; EINE REIHE FLEXIBLER LÖSUNGEN, DIE IN DER LAGE SIND, FUNKTIONALITÄT UND ÄSTHETIK ZU VERBINDEN.

ESTHÉTIQUE EXCLUSIVE DUE AUX GÉOMÉTRIES PURES DES POIGNÉES EN ALUMINIUM POUVANT ÊTRE APPLIQUÉES AU CENTRE OU À L'EXTRÉMITÉ DES FAÇADES. DISPONIBLE TRANSVERSALEMENT DANS TOUTES LES FINITIONS DE LA GAMME **ARCHEDA**. UN PROJET CARACTÉRISÉ PAR LA SIMPLICITÉ ET LA RIGUEUR ; UN ENSEMBLE DE PROPOSITIONS FLEXIBLES, EN MESURE DE SUGGÉRER À LA FOIS FONCTIONNALITÉ ET ESTHÉTIQUE.

UNA ESTÉTICA EXCLUSIVA FRUTO DE LAS FORMAS PURAS DE LOS TIRADORES DE ALUMINIO, QUE SE PUEDEN MONTAR EN EL CENTRO O EN EL EXTREMO DE LOS FRENTE. DISPONIBLE EN SENTIDO TRANSVERSAL EN TODOS LOS ACABADOS DE LA GAMA **ARCHEDA**. UN PROYECTO CARACTERIZADO POR SU SENCILLEZ Y RIGOR; UN CONJUNTO DE PROPUESTAS FLEXIBLES, CAPACES DE TRANSMITIR FUNCIONALIDAD Y ESTÉTICA AL MISMO TIEMPO.

## MANIGLIE

Handles / Poignées  
Griffe / Tiradores

### MANIGLIA INTERA

Full handle  
Poignée entière  
Ganzer Griff  
Tirador entero

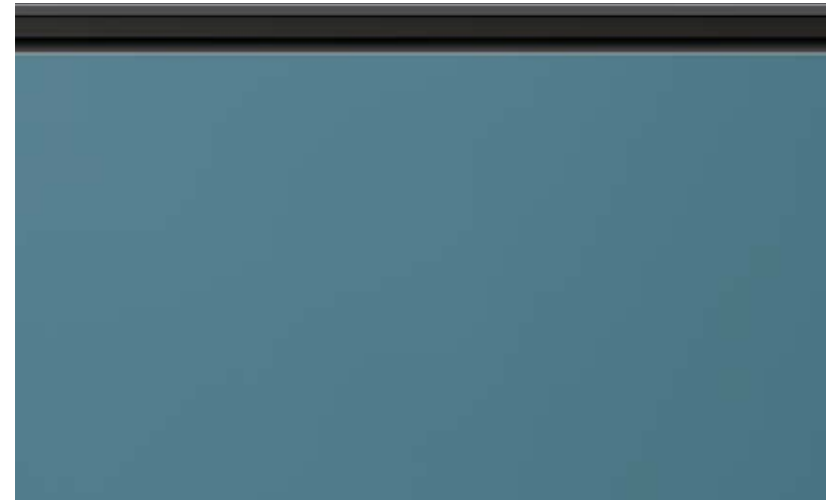

### MANIGLIA DESTRA

Right handle  
Poignée droite  
Rechter Griff  
Tirador derecho

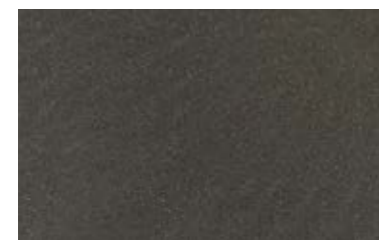
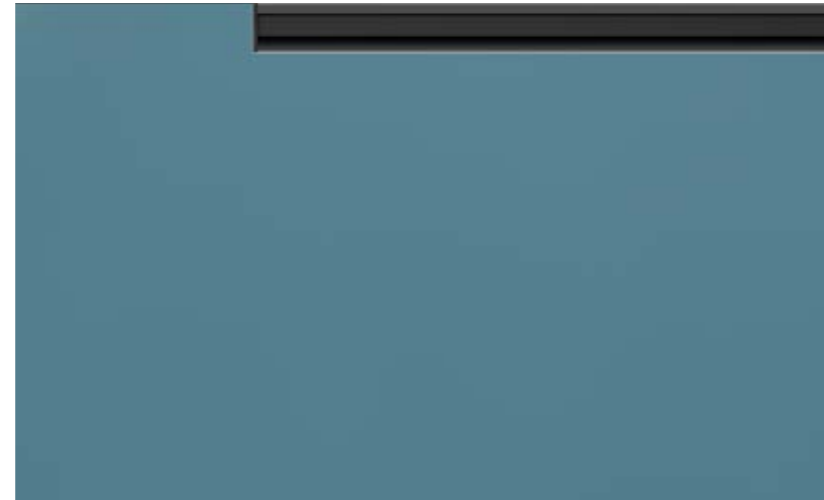

TITANIO



ALLUMINIO  
SATINATO

### MANIGLIE FINITURE

Handles finishes  
Finitions des poignées  
Griffe Oberflächen  
Acabados

### MANIGLIA SINISTRA

Left handle  
Poignée gauche  
Linker Griff  
Tirador izquierdo

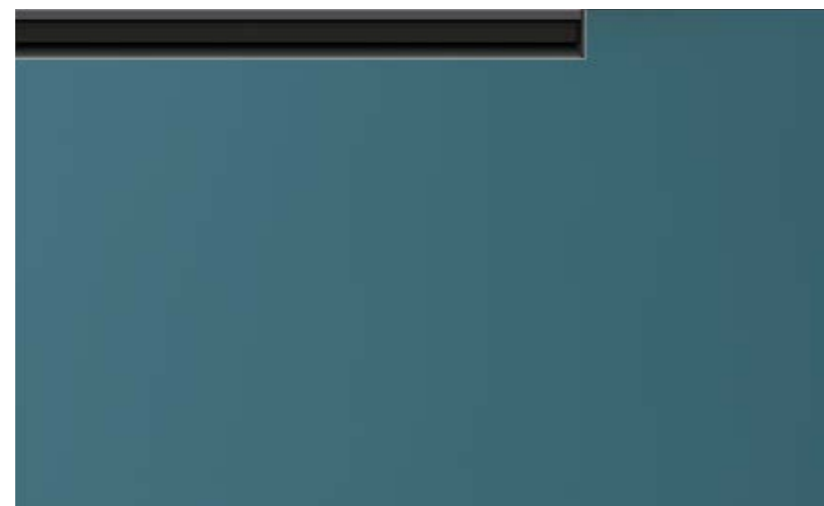

## COMPOSIZIONI

Compositions / Compositions  
Kompositionen / Composiciones

### FRONTALE SINGOLO MANIGLIA LATERALE

Single front - Side handle  
Simple façade - Poignée latérale  
Einzelne Front - Seitengriff  
Solo frente - Tirador lateral



### FRONTALE SINGOLO MANIGLIA INTERA

Single front - Full handle  
Simple façade - Poignée entière  
Einzelne Front - Ganzer Griff  
Solo frente - Tirador entero



### 3 FRONTALI MANIGLIE LATERALI + INTERA

3 fronts - side+full handles  
3 façades - poignées latérales+entière  
3 Fronten - Seitengriffe+Ganzergriff  
3 frentes - Tiradores laterales+entero



### 2 FRONTALI MANIGLIE LATERALI

2 fronts - side handles  
2 façades - poignées latérales  
2 Fronten - Seitengriffe  
2 frentes - Tiradores laterales



## COMPOSIZIONE 01

Hpl Tobacco 440 con maniglia Titanio e base a giorno laccata Fard opaco. Top in HPL Tobacco 440 con lavabo Lake in vetro fumé. Specchio Saturn con lampada Compasso.

Hpl Tobacco 440 with Titanio handle and Fard matt lacquered open element. Hpl Tobacco 440 top with fumé glass basin Lake. Saturn mirror with Compasso Lamp.

Hpl Tobacco 440 avec poignée Titanio et élément ouvert Fard mat. Plan de toilette en Hpl Tobacco 440 avec vasque en verre fumé Lake. Miroir Saturn avec lampe Compasso.

Hpl Tobacco 440 mit Griffe Titanio und offen Unterschrank Fard matt lackiert. Waschtischplatte Hpl Tobacco 440 mit Becken Lake aus Dunkelgrauglas. Spiegel Saturn mit Lampe Compasso.

Hpl Tobacco 440 con tirador Titanio y módulo abierto Fard mate. Encimera de Hpl Tobacco 440 con cuba Lake de vidrio ahumado. Espejo Saturn con lámpara Compasso.

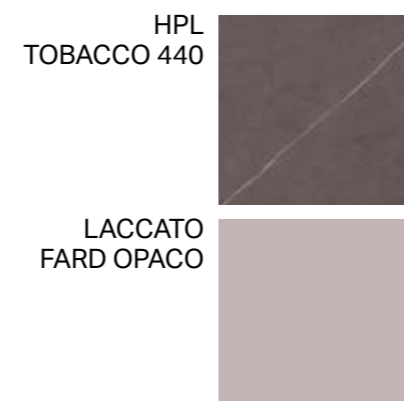
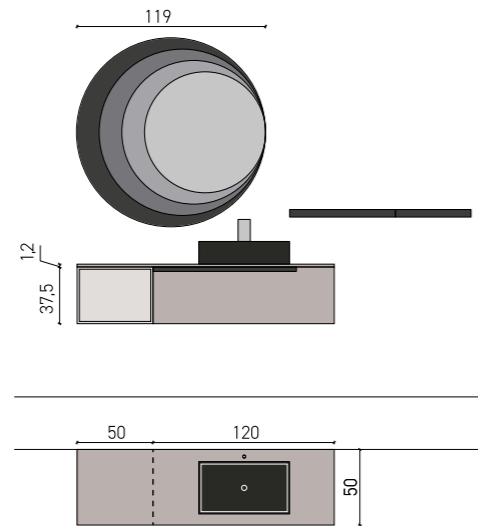





**La linearità unita  
all'armonia**

Linear harmony  
La linéarité unie à l'harmonie  
Linearität mit Harmonie vereint  
La linealidad unida a la armonía





**Lavabo Lake  
in vetro grigio fumè**

Lake washbasin in Fumé glass  
Lavabo Lake en verre Fumé  
Waschbecken Lake aus Dunkelgrauglas  
Lavabo Lake de cristal gris fumé





**Specchio Saturn:  
sfumature che donano emozioni**

Saturn mirror: shades guaranteed to stimulate the senses  
Miroir Saturn : des nuances qui donnent des émotions  
Spiegel Saturn: Nuancen, die Emotionen wecken  
Espejo Saturn: matices que aportan emociones







## COMPOSIZIONE 02

**Bimelaminico Minato e laccato  
Petrolio opaco con maniglie Titanio.  
Top Corian con vasca integrata  
CN. Specchi Jupiter e Sputnik con  
lampada Compasso.**

Minato Bimelaminated and Petrolio  
matt with Titanio handles. Corian top  
with CN integrated basin. Jupiter and  
Sputnik mirrors with Compasso.

Bi-mélatiné Minato et Petrolio mat et  
poignée Titanio. Pd.T en Corian avec  
vasque intégrée CN. Miroirs Jupiter et  
Sputnik avec lampe Compasso.

Bimelamin Minato und Petrolio  
lackiert matt mit Griffen Titanio.  
Waschtischplatte Corian mit  
integriertem Becken CN.  
Jupiter und Sputnik Spiegeln mit  
Lampe Compasso.

Bi-melamina Minato y lacado Petrolio  
mate con tiradores Titanio. Encimera  
Corian con cuba integrada CN.  
Espejos Jupiter y Sputnik con  
lámpara Compasso.

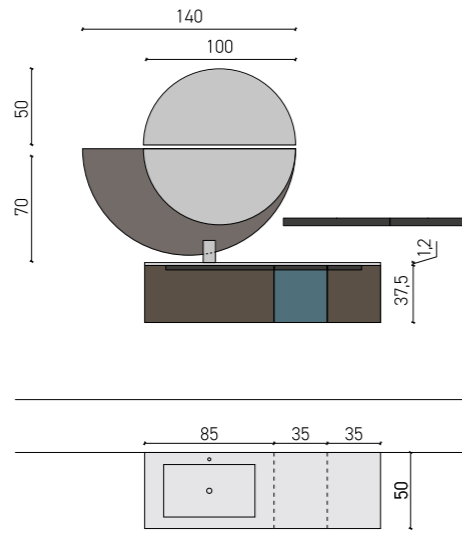

BIMELAMINICO  
MINATO

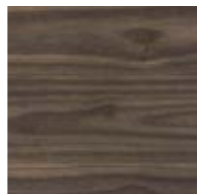

LACCATO  
PETROLIO OPACO



CORIAN











**Movimenti in libertà:  
la lampada Compasso**

Move freely with the Compasso light  
Mouvements en liberté : la lampe Compasso  
Bewegungen voller Freiheit: die Lampe Compasso  
Libertad de movimiento: la lámpara Compasso



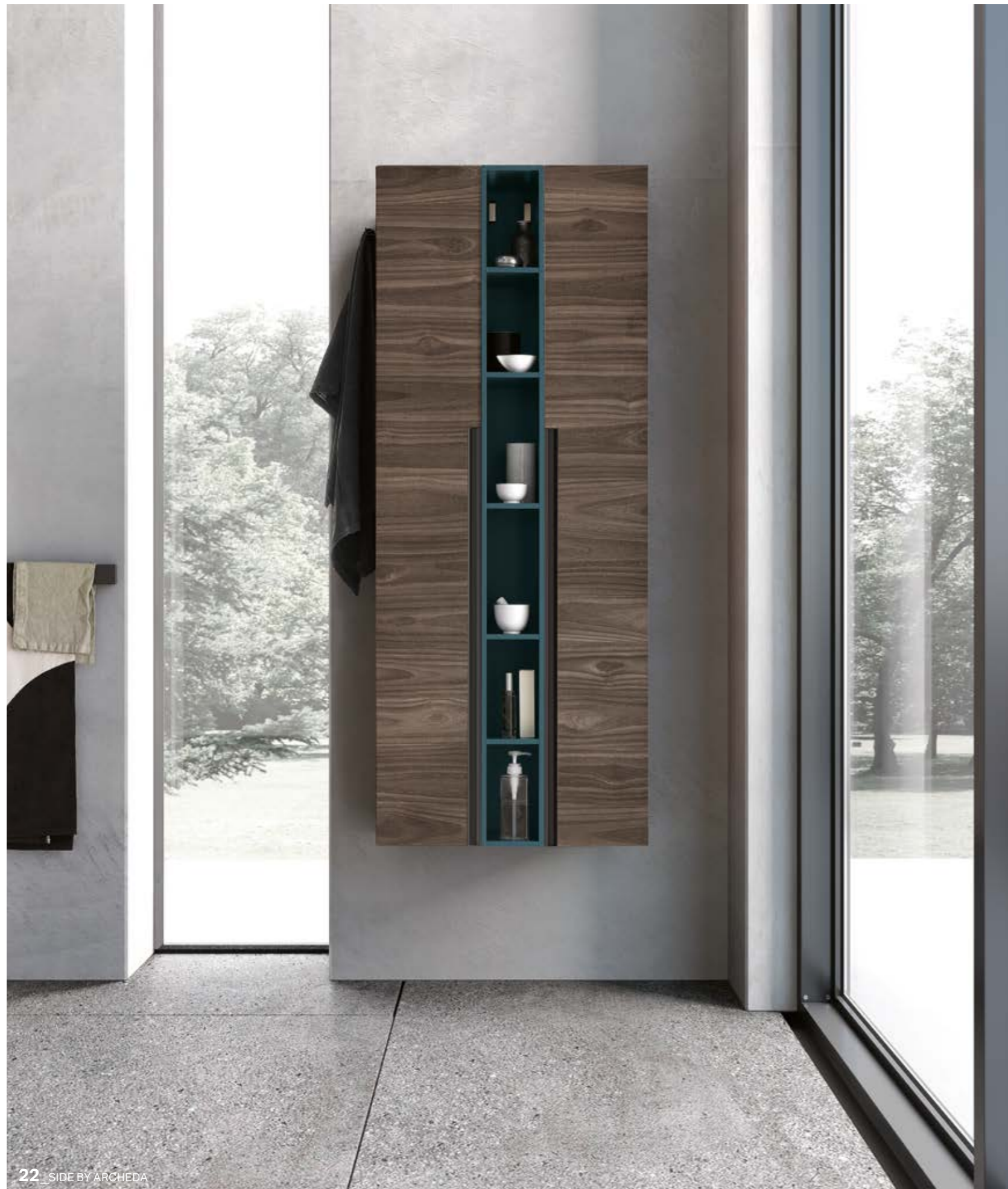

**Le colonne:  
contenere in piena vista**

Storage space in full view with these tall units  
Les colonnes : ranger en pleine vue  
Unsere Hochschränke: Aufbewahren mit Einblicken  
Las columnas: almacenamiento a plena vista









## COMPOSIZIONE 03

**Basi finitura bmelaminico Ares Beton e Ares Calce con maniglie alluminio satinato e top H. 6 cm in gres Pietra Grey con vasca integrata GF. Specchi Sputnik con illuminazione a led perimetrale.**

Ares Beton and Ares Calce bmelaminated base units with aluminium matt handles. Th.6 cm Pietra Grey gres tops with GF integrated basins. Sputnik mirrors with perimetral led lighting.

Éléments bas en bi-méla miné Ares Beton et Ares Calce avec poignée aluminium et Pd.T. en Gres Pietra Grey avec vasque intégrée GF. Miroirs Sputnik avec éclairage périmétrique.

Unterschränke aus Bimelamin Ares Beton und Ares Calce mit Griffe Aluminium Satiniert und Waschtischplatten Gres Pietra Grey St.6 cm mit integriertem Becken GF. Spiegeln Sputnik mit perimetralen-LED.

Muebles de suelo en bi-melamina Ares Beton y Ares Calce con tiradores aluminio y encimera esp. 6 cm de gres Pietra Grey con cuba integrada GF. Espejos Sputnik con iluminación LED perimetral.

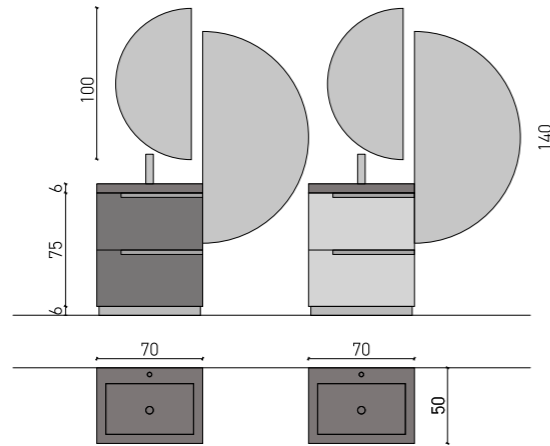

BIMELAMICO  
ARES BETON



BIMELAMICO  
ARES CALCE



GRES  
PIETRA GREY





**Piccoli volumi  
per grandi emozioni**

Small shapes for big ideas  
De petits volumes pour de grandes émotions  
Kleine Volumen für große Emotionen  
Pequeños volúmenes para grandes emociones







### Scorci sui dettagli più accattivanti

Captivating details  
Aperçus sur les détails les plus captivants  
Entdecken Sie die fesselndsten Details  
Un vistazo a los detalles más interesantes





**Accessori INSIDE: la linearità  
che contiene con classe ed eleganza**

INSIDE accessories: linear storage space offering class and elegance  
Accessoires INSIDE : la linéarité qui contient avec classe et élégance  
INSIDE-Accessoires: Linearität mit Klasse und Eleganz  
Accesorios INSIDE: la linealidad que almacena con clase y elegancia









## COMPOSIZIONE 04

**Bimelaminico Rovere Spaccato con maniglie Titanio e top in gres Ossido Bruno con vasca integrata GK. Specchi esagonali Ride con profilo nero e illuminazione perimetrale a led.**

Rovere Spaccato Bimelaminated with Titanio handles. Ossido Bruno gres top with GK integrated basin. Ride hexagonal mirrors with black aluminum profile and perimetral led lighting.

Bi-mélatiné Rovere Spaccato avec poignée Titanio et Pd.T en gres Ossido Bruno avec vasque intégrée GK. Miroirs hexagonaux Ride avec profils noirs et éclairage périmétrique.

Bimelamin Rovere Spaccato mit Griffen Titanio und Waschtischplatte Gres Ossido Bruno St. 6 cm mit integriertem Becken GK. Sechseckigen Ride Spiegel mit schwarzem Profil und perimetralen-Led.

Bi-melamina Rovere Spaccato con tiradores Titanio y encimera de gres Ossido Bruno con cuba integrada GK. Espejos hexagonales Ride con perfil negro y iluminación LED perimetral.

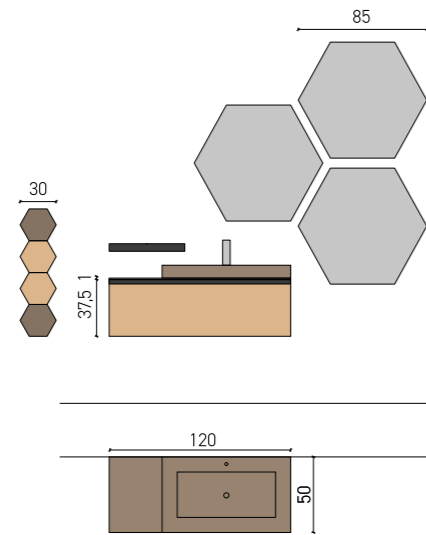

BIMELAMINICO  
ROVERE SPACCATO



LACCATO  
LIQUIRIZIA OPACO



GRES  
OSSIDO BRUNO

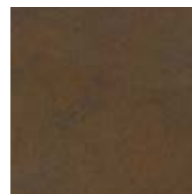





**Complementi che arredano  
con stile ed eleganza**

Furnishings to decorate your space in style and elegance  
Des compléments qui décorent avec style et élégance  
Einrichtungsgegenstände, die mit Stil und Eleganz einrichten  
Complementos que amueblan con estilo y elegancia





**Attenzione e cura  
per i dettagli**

Attention to detail  
Attention et soin des détails  
Aufmerksamkeit und Liebe zum Detail  
Atención y cuidado en los detalles





**Tonalità calde ed avvolgenti:  
rovere spaccato e liquirizia opaco**

Warm, inviting shades: Rovere Spaccato and matt Liquirizia  
Tonalités chaudes et enveloppantes : Rovere Spaccato et Liquirizia Mat  
Warme und einhüllende Farbtöne: Rovere Spaccato und Liquirizia Matt  
Tonos cálidos y envolventes: Rovere Spaccato y Liquirizia Mate









## COMPOSIZIONE 05

Anice opaco con maniglie Titanio e top Geacryl color Matt Anice h.6 cm con vasca integrata G. Specchio Ride con lampada Pens. Elementi a giorno esagonali in metallo Titanio con retro laccato Anice opaco.

Anice matt lacquered with Titanio handles and th. 6 cm Geacryl Color matt top in Anice finish with G integrated basin. Ride mirror with Pens lamp. Hexagonal Titanio painted metal open elements with Anice matt lacquered backs.

Anice mat avec poignée Titanio et P.d.T en Geacryl Color Matt Anice ép. 6 cm avec vasque intégrée G. Miroir Ride avec lampe Pens. Éléments ouverts hexagonaux en métal titanio et Anice mat.

Anice matt lackiert mit Griffen Titanio und Waschtischplatte Geacryl Color Matt Anice St. 6 cm mit integriertem Becken G. Spiegel Ride mit Lampe Pens. Sechseckigen offene Metallelementen Titanio mit Rückwand Anice matt lackiert.

Anice mate con tiradores Titanio y encimera de Geacryl Color Matt Anice esp. 6 cm con cuba integrada G. Espejo Ride con lámpara Pens. Módulos abiertos hexagonales de metal Titanio con panel trasero lacado Anice mate.

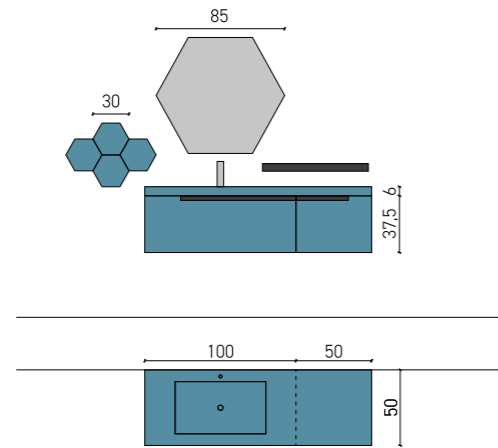

LACCATO  
ANICE OPACO



GEACRYL  
COLOR MATT ANICE





**Giochi di forme  
e di colori**

Play with shapes and colours  
Jeux de formes et de coloris  
Form- und Farbspiele  
Juegos de formas y colores







### Top in Geacryl Color Matt in tutte le tonalità opache Archeda

Geacryl Color Matt top in all Archeda matt shades  
Plan de toilette en Geacryl Color Matt dans toutes les tonalités mates Archeda  
Geacryl Color Matt-Platte in verschiedenen matten Farbtönen der Reihe Archeda  
Encimera de Geacryl Color Matt en todos los tonos mate de Archeda













## COMPOSIZIONE 06

**Bimelaminico Shibuya con maniglie Titanio. Top in Fenix Nero 720 con vasca integrata HG. Specchi Line con lampada Compasso.**

Shibuya bime laminated with Titanio handles. Fenix Nero 720 top with HG integrated basin. Line mirrors with Compasso lamp.

Bi-mé laminé Shibuya avec poignée Titanio. Pd.T en Fenix Nero 720 avec vasque intégrée HG. Miroirs Line avec lampe Compasso.

Bimelamin Shibuya mit Griffen Titanio. Waschtischplatte Fenix Nero 720 mit integriertem Becken HG. Spiegel Line mit Lampe Compasso.

Bi-melamina Shibuya con tiradores Titanio. Encimera de Fenix Nero 720 con cuba integrada HG. Espejos Line con lámpara Compasso.

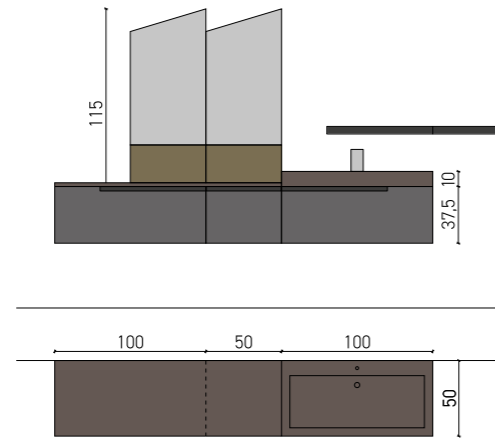

BIMELAMINICO  
SHIBUYA



FENIX  
NERO 720







**Proposte sempre versatili  
e dallo stile unico**

Versatile products offering unique style  
Des propositions toujours versatiles et au style unique  
Immer vielseitige und einzigartige Stilvorschläge  
Propuestas siempre versátiles y de estilo único



**Lampada Compasso:  
scegli la tua angolazione preferita**

Compasso light: choose your favourite angle  
Lampe Compasso : choisissez votre angle préféré  
Lampe Compasso: Wählen Sie Ihren Lieblingswinkel  
Lámpara Compasso: elige tu ángulo favorito







**Tutto a posto:  
i cassettoni attrezzati con Inside**

Everything has its place: spacious, accessorised drawers with Inside  
Tout est à sa place : les grands tiroirs équipés avec Inside  
Alles an seinem Platz: Schubladen ausgestattet mit Inside  
Todo en su sitio: las gavetas equipadas con Inside





**Archeda:  
arredare con una marcia in più**

Archeda: interior design with an edge  
Archeda : meubler à la vitesse supérieure  
Archeda: Einrichten auf der Überholspur  
Archeda: amueblar subiendo de marcha





## COMPOSIZIONE 07

Hpl Antique con maniglie Titanio;  
piano in vetro acidato Bosco con  
vasca integrata VF. Specchi Bee in  
metallo Titanio con lampade Pens.

Hpl Antique with Titanio handles;  
Bosco acid-etched glass top with  
VF integrated basins. Titanio metal Bee  
mirrors with Pens lamps.

Hpl Antique avec poignée Titanio. Pd.T  
en verre dépoli Bosco avec vasque  
intégrée VF. Miroirs Bee en métal  
Titanio avec lampes Pens.

Hpl Antique mit Griffen Titanio;  
Waschtischplatte Glas geätzt Bosco mit  
VF integriertem Becken. Spiegeln Bee  
aus Metall Titanio mit Lampen Pens.

Hpl Antique con tiradores Titanio;  
encimera de cristal al ácido Bosco  
con cuba integrada VF. Espejos Bee  
de metal Titanio con lámparas Pens.

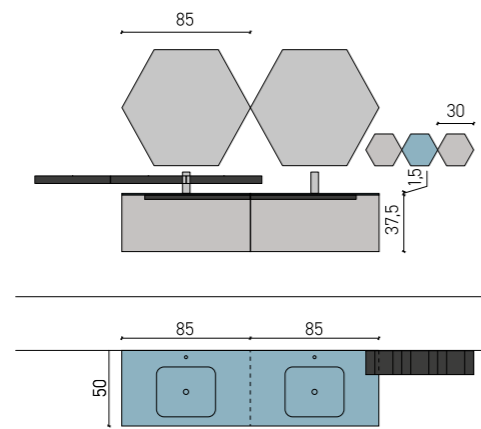

HPL  
ANTIQUE



LACCATO  
BOSCO OPACO



VETRO ACIDATO  
BOSCO







**Materiali diversi  
per uno stile unico**

Different materials for a unique style  
Différents matériaux pour un style unique  
Verschiedene Materialien für einen einzigartigen Stil  
Diferentes materiales para un estilo único



**Vetro acidato:  
scegli la tua tonalità**

Acid-etched glass: choose your shade  
Verre dépoli : choisissez votre tonalité  
Geätztes Glas: Wählen Sie Ihren Farbton  
Cristal al ácido: elige tu tono





**Elementi a giorno Esagono,  
che finitura dello schienale scegli?**

Esagono open elements: choose your back finish  
Éléments ouverts Esagono : quelle finition choisissez-vous pour le fond ?  
Esagono Offenelemente: Welches Finish wählen Sie für die Rückwand?  
Elementos abiertos Esagono: ¿qué acabado eliges para la trasera?









## COMPOSIZIONE 08

**Blu Moby opaco con maniglie alluminio satinato e piano in vetro acidato Cipria con vasca integrata VG. Elementi a giorno in metallo bianco con retro laccato Fard e Finestra opaco, specchio Luna.**

Blu Moby matt with aluminim handles and Cipria acid-etched glass top with VG integrated basin. White metal open elements with Fard matt end Finestra matt lacquered backs, Luna mirror.

Blu Moby matt avec poignées aluminium et Pd.T en verre dépoli Cipria avec vasque intégrée VG. Éléments ouverts en métal blanc et panneau arrière lacquée Fard et Finestra mat, miroir Luna.

Blu Moby matt lackiert mit Griffen Aluminium Satiniert un Waschtischplatte Glas geätzt Cipria mit VG integriertem Becken. Offene Metallelementen Titanio mit Rückwande Fard un Finestra lackiert. Spiegel Luna.

Lacado Blu Moby mate con tiradores aluminio y encimera cristal al ácido Cipria con cuba integrada VG. Módulos abiertos de metal blanco con panel trasero lacado Fard mate y Finestra mate, espejo Luna.

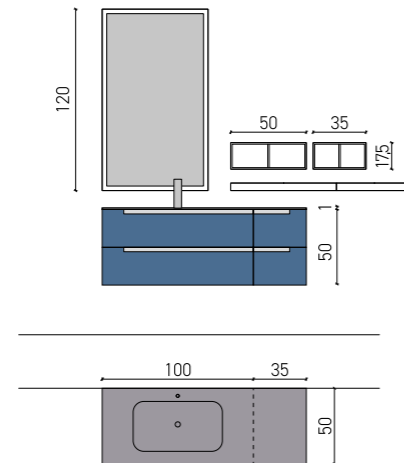

LACCATO  
BLU MOBY OPACO



VETRO ACIDATO  
CIPRIA



LACCATO  
FARD OPACO



LACCATO  
FINESTRA OPACO



LACCATO  
CIPRIA OPACO





**Modularità creativa  
per arredare con Archeda**

Creative modular units to design your interiors with Archeda  
Modularité créative pour meubler avec Archeda  
Archeda bietet Ihnen kreative Modularität bei der Ausstattung  
Modularidad creativa para amueblar con Archeda





**Accessori Strike e cassetti attrezzati Inside:  
scegli la tua combinazione**

Strike accessories and accessorised Inside drawers: choose your combination  
Accessoires Strike et tiroirs équipés Inside : choisissez votre combinaison  
Zubehör Strike und ausgestattete Schubladen Inside: Wählen Sie Ihre Kombination  
Accesorios Strike y cajones equipados Inside: elige tu combinación













## COMPOSIZIONE 09

**Bianco opaco con maniglia Titanio e base a giorno Titanio opaco. Top in gres Striato opaco con lavabo Regolo in Tecnoril. Specchi Sputnik con led perimetrali e lampade a sospensione Tube nere.**

White matt with Titanio handles and Titanio matt lacquered open element. Striato gres top with Tecnoril Regolo basin. Sputnik mirrors with perimetral led lighting and Tube black hanging lamps.

Bianco mat avec poignée Titanio et éléments bas ouvert lacquée Titanio mat. P.d.T en gres Striato opaco avec vasque Regolo en Tecnoril. Miroirs Sputnik avec éclairage périmétrique et lampe Tube noir.

Bianco matt lackiert mit Griffe Titanio und offen Unterschrank Titanio matt lackiert. Waschtischplatte Gres Striato opaco mit Becken Tecnoril Regolo. Spiegel Sputnik mit perimetralen-LED und schwarzen Lampen Tube.

Bianco mate con tiradores Titanio y módulo abierto Titanio mate. Encimera de gres Striato opaco con cuba Regolo de Tecnoril. Espejos Sputnik con iluminación LED perimetral y lámparas Tube negras.

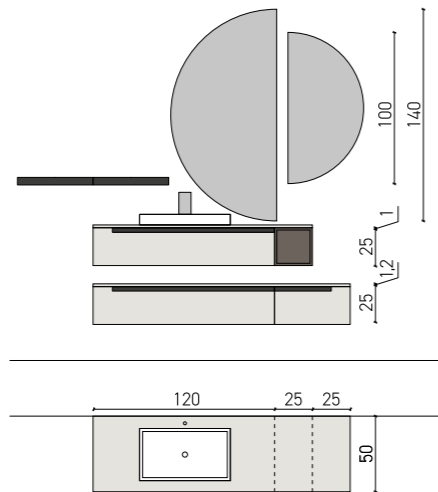

GRES  
STRIATO OPACO



LACCATO  
BIANCO OPACO



LACCATO  
TITANIO OPACO

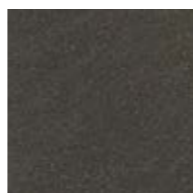



**Contrasti cromatici  
per i piccoli dettagli**

Small details with colour contrasts  
Contrastes chromatiques pour les petits détails  
Farbkontraste für kleine Details  
Contrastes cromáticos para los pequeños detalles







**Armonie di colori  
in un contrasto di texture**

Harmonious colours and contrasting textures  
Harmonie de coloris dans un contraste de texture  
Harmonie der Farben in Kontrast zu den Strukturen  
Armonía de colores en un contraste de texturas





**Scegli il tuo stile  
in completa libertà**

Choose your own style in absolute freedom  
Choisissez votre style en toute liberté  
Wählen Sie Ihren Stil völlig frei  
Elige tu estilo con total libertad









## Specchi

Mirrors  
Miroirs  
Spiegeln  
Espejos



SKY + LINE

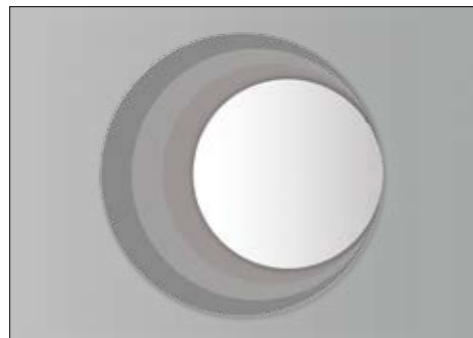

SATURN

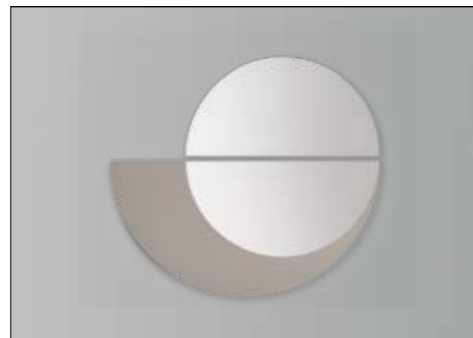

JUPITER + SPUTNIK

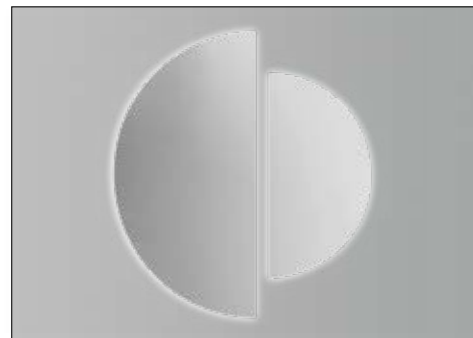

SPUTNIK

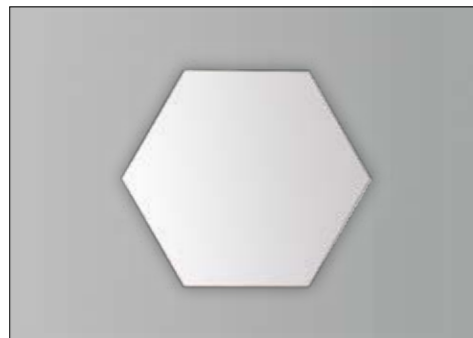

RIDE



BEE

## Inside:

### accessori per cassetti

Inside: accessories for drawers  
Inside: accessoires pour tiroirs  
Inside: Accessoires für Schubladen  
Inside: accesorios para cajones Inside



L. 50 P. 50



L. 60 P. 50



L. 70 P. 50



L. 85 P. 50



L. 95 P. 50



L. 100 P. 50



L. 105 P. 50



L. 120 P. 50



## Nuove finiture

New finishes  
Nouvelles finitions  
Neue Oberflächen  
Nuevos acabados



## Top Geacryl Color Matt

Geacryl Color Matt top  
Pd.T Geacryl Color Matt  
Waschtischplatte Geacryl Color Matt  
Encimera de Geacryl Color Matt



(no bianco, nero, oro,  
alluminio e titanio)



## Fenix

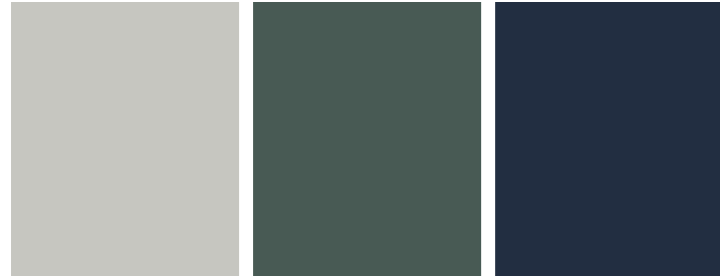

GRIGIO  
EFESO 725

VERDE COMODORO  
750

BLU  
FES 754

## Hpl

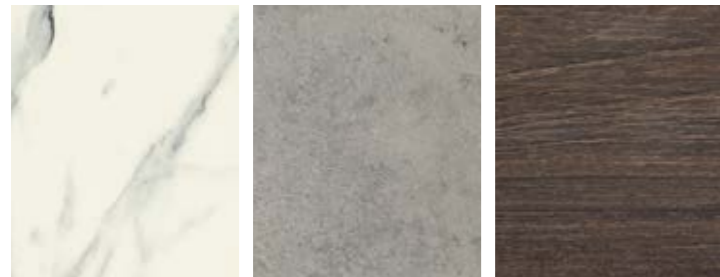

STATUARIO S. T. 439

CEMENTO 143

OLMO SCURO 303

## Bimelaminico syncro

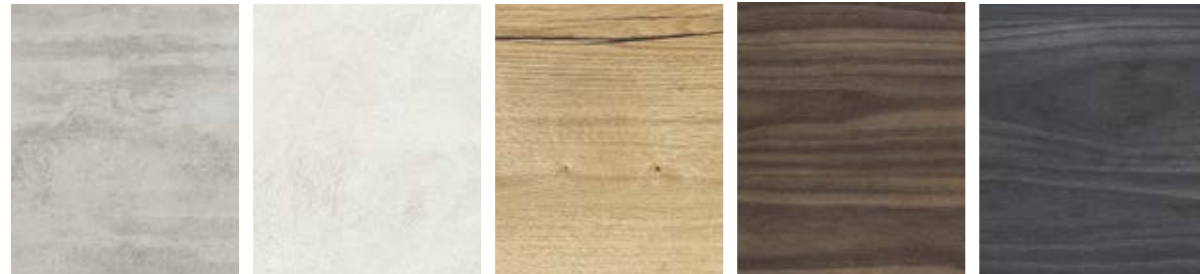

ARES BETON

ARES CALCE

ROVERE SPACCATO

MINATO

SHIBUYA

## Top in vetro acidato

Acid-etched glass top  
Plan de toilette en verre dépoli  
Geätzte Glasplatte  
Encimera de cristal al ácido



(no nero)





## Finiture

Finishes  
Finitions  
Oberflächen  
Acabados

### Laccato opaco/lucido

Matt/gloss lacquered / Lacquée mat et brillant  
Matt oder glänzend lackiert / Lacado mate y brillo



BIANCO 01    NUVOLA 58    CENERE 06    KAKI 07    GRAFITE 02    FERRO 03    NERO 04



VANIGLIA 59    JUTA 60    CANAPA 61    LIQUIRIZIA 62    FANGO 63    TERRA 14    CACAO 64



PAPIRO 57    AVENA 56    FIENO 55    GIADA 38    BOSCO 37    PETROLIO 72    NAFTA 75



TURCHESE 74    MENTA 73    PAVONE 71    NEBBIA 39    POLVERE 46    ANICE 49    AVIO 44



BLU MOBY 47    OLTREMARE 48    LINO 49    FINESTRA 08    FARD 54    CIPRIA 53    CARMINIO 29



BORDEAUX 24    ROSSO INDIA 26    AMBRA 16    ZAFFERANO 15    RAL + NCS

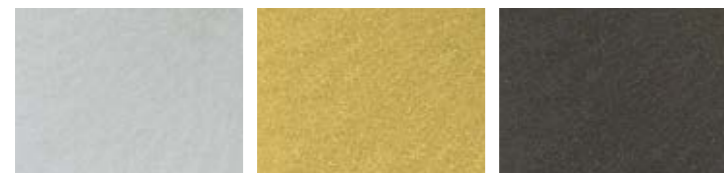

MET. ALLUMINIO 05\*    MET. ORO 17\*    MET. TITANIO 09\*

\*Solo opaco  
Matt only / Seulement mat  
Nur matt / Solo mate

## Finiture

Finishes  
Finitions  
Oberflächen  
Acabados

### Laccato metal

Metal lacquered / Lacqué Metal  
Metal lackiert / Lacado Metal

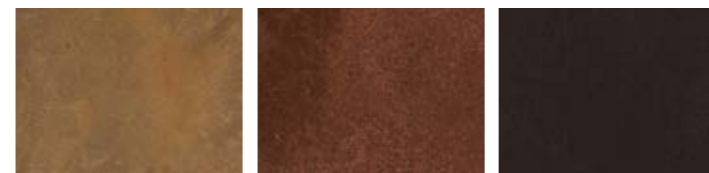

OTTONE ANTICO    CORTEN    ACCIAIO

### Bimelaminico skin

Bimelaminated Skin / Bi-mé laminé Skin  
Bimelamin Skin / Bi-melamina Skin



SKIN BIANCO    SKIN GRIGIO    SKIN JEREZ

### Bimelaminico syncro

Bimelaminated Syncro / Bi-mé laminé Syncro  
Bimelamin Syncro / Bi-melamina Syncro



ARES BETON    ARES CALCE    ROVERE SPACCATO    MINATO    SHIBUYA

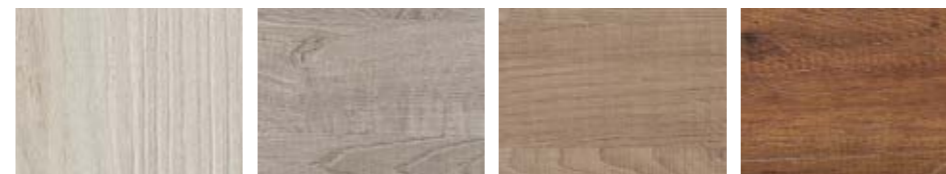

OLMO COCCO    NODATO LONDRA    NODATO SAVANA    NODATO CANYON



## Finiture

Finishes  
Finitions  
Oberflächen  
Acabados

## Legni



ROVERE NORDICO NATURALE ROVERE NORDICO CIOCCOLATO ROVERE NORDICO CAFFÈ NOCE CANALETTO OLMO EUCALIPTO AFFUMICATO

### Rovere fiammato decapé

Decapé Fiammato Oak / Chêne Fiammato Decapé  
Decapé Fiammato Eiche / Roble Fiammato Decapé



BIANCO PORO SCURO JUTA PORO BIANCO CANAPA PORO BIANCO FINESTRA PORO BIANCO POLVERE PORO BIANCO AVIO PORO BIANCO

### Rovere fiammato tinto

Fiammato Oak / Chêne Fiammato Teinté  
Fiammato Eiche / Roble Fiammato

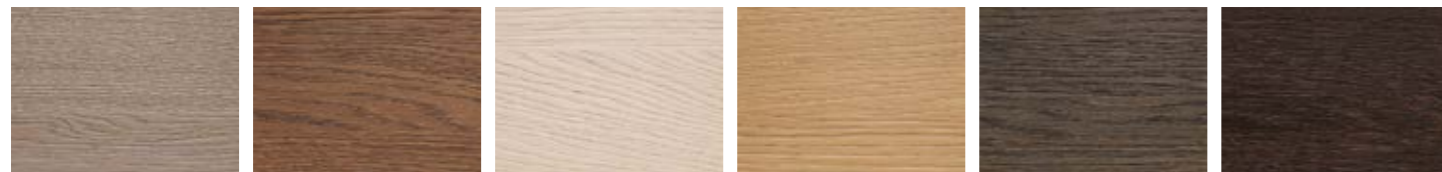

AGATA CASTAGNA CORDA GRANO QUARZO TARTUFO

### Rovere fiammato laccato poro aperto

Open pore lacquered Fiammato Oak / Chêne Fiammato lacqué pore ouvert  
Offen porig lackiert Fiammato Eiche / Roble Fiammato lacado poro abierto



BIANCO



CAMPIONARIO ARCHEDA

## Finiture

Finishes  
Finitions  
Oberflächen  
Acabados

## Hpl unicolor



STATUARIO S. T. 439 CEMENTO 143 OLMO SCURO 303 OLMO BIONDO 134 ROVERE MONET 423 ROVERE TEXAS 306 ROVERE VERSAILLES 418

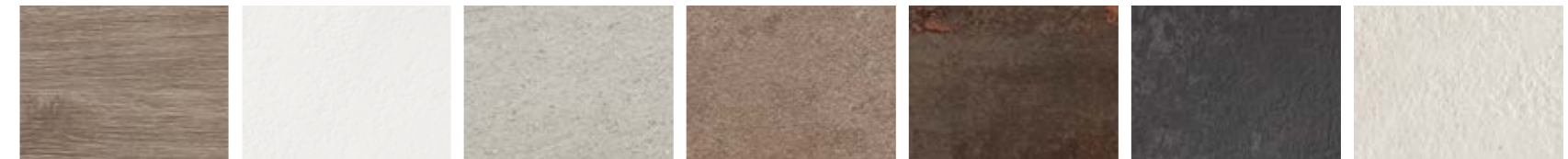

ROVERE CASTORO 301 SASSO 139 BASALTO 403 PORFIDO 119 OSSIDO 146 ARDESIA 145 MALTA BIANCA 430



MALTA GRIGIA 431 MALTA CANAPA 432 ANTIQUE MAILAND 441 BOTTICINO 410 CUMA DARK 428 CALYPSO 435



TOBACCO 440 IMPERO 438

## Fenix



GRIGIO EFESO 725 VERDE COMODORO 750 BLU FES 754

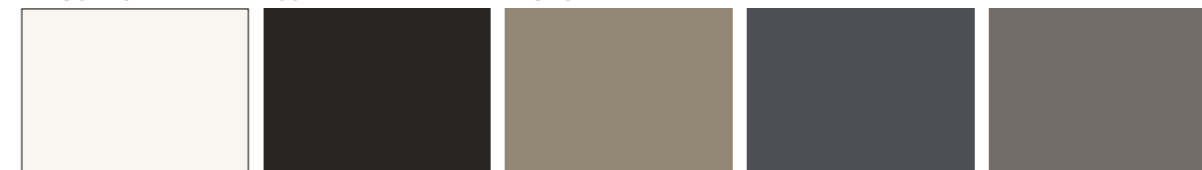

BIANCO 32 NERO 720 BIBER 717 BROMO 724 GRIGIO 718



CATALOGUE PLANNIG  
Maurizio Poletto

DESIGN E A.D.  
Dario Poles

GRAPHIC DESIGN CATALOGO  
Graphosds

FOTOGRAFIA  
Gabriotti Fotografi

FOTOLITO E STAMPA  
graficheitalprint.it

NOVEMBRE 2020

Archeda, al fine di migliorare le caratteristiche tecniche e qualitative della sua produzione, si riserva di apportare, anche senza preavviso, tutte le modifiche che si rendessero necessarie.

To improve the technical and the qualitative characteristics of the production, Archeda reserves the right to make all the suitable modifications without previous notice.

A fin daméliorer les caractéristiques techniques et qualitatives de sa production, la société Archeda se réserve le droit d'apporter, même sans preavis, toutes les modifications qui seront jugées nécessaires.

Um technische und qualitative Merkmale der Produktion zu verbessern, behält sich Archeda vor, alle nötige Abänderungen, ohne Avisierungen, vorzunehmen.

Archeda, a fin de mejorar las características técnicas y cualitativas de su producción, se reserva el derecho de aportar, incluso sin previo aviso, todas las modificaciones necesarias.





ARCHEDA s.r.l. via A. Malignani, 7 33080 Porcia (Pn) [www.archeda.eu](http://www.archeda.eu)