

sistema

GOLA

LINEA | TULLE | GOLA





STORIA DELL'AZIENDA ARCHEDA

FONDATA NEL 1996, ARCHEDA È UNA REALTÀ CHE HA TROVATO IL SUO SPIRITO GUIDA ALL'INTERNO DI UNA FILOSOFIA DETTATA DA UNA FORTE CARICA MORALE. AL CENTRO DEL PROGETTO, C'È LA VOGLIA DI CREARE NUOVE EMOZIONI, LAVORANDO SULLA FORME E SUL DESIGN, SULLA RICERCA, SULLA QUALITÀ DEI MATERIALI E DELLE LAVORAZIONI, RISPETTANDO LE ESIGENZE ERGONOMICHE E FUNZIONALI

FOUNDED IN 1996, ARCHEDA IS A REALITY THAT HAS FOUND HIS SPIRIT GUIDE IN A PHILOSOPHY DICTATED BY A STRONG MORAL. AT THE CENTER OF THE PROJECT, THERE IS THE DESIRE TO CREATE NEW EMOTIONS, WORKING ON FORMS AND DESIGN, RESEARCH, THE QUALITY OF MATERIALS AND WORKMANSHIP, RESPECTING THE ERGONOMIC AND FUNCTIONAL NEEDS

FONDÉE EN 1996, ARCHEDA EST UNE RÉALITÉ QU'IL A TROUVÉ SON GUIDE SPIRITUEL DANS UNE PHILOSOPHIE DICTÉE PAR UNE MORALE FORTE. AU CENTRE DU PROJET, IL YA LE DÉSIR DE CRÉER DE NOUVELLES ÉMOTIONS, DE TRAVAIL SUR LES FORMES ET LA CONCEPTION, LA RECHERCHE, LA QUALITÉ DES MATÉRIAUX ET DE FABRICATION, EN RESPECTANT LES BESOINS ERGONOMIQUES ET FONCTIONNELS

1996 GEGRÜNDET, ARCHEDA IST EINE REALITÄT, DIE SEIN FÜHRUNGSGEIST IN EINE PHILOSOPHIE GEFUNDEN HAT, WELCHE VON STARK MORALISCHEN IDEEN DIKTIERT IST. IM ZENTRUM DES PROJEKTS STEHT DER WUNSCH, NEUE EMOTIONEN ZU SCHAFFEN, DIES IST MÖGLICH DANK EINE STARKERN ARBEITN AN FORMEN UND DESIGN, FORSCHUNG DER QUALITÄT DER MATERIALIEN UND DEREN VERARBEITUNG, DIES IMMER UNTER BEACHTUNG DER ERGONOMISCHEN UND FUNKTIONALEN ANFORDERUNGEN

FUNDADA EN 1996, ARCHEDA ES UNA REALIDAD HA QUE ENCONTRADO A SU GUÍA ESPIRITUAL EN UNA FILOSOFÍA DICTADA POR UNA FUERTE CARGA MORAL. EN EL CENTRO DEL PROYECTO, ESTÁ EL DESEO DE CREAR NUEVAS EMOIONES, TRABAJANDO EN LAS FORMAS Y EL DISEÑO, LA INVESTIGACIÓN, LA CALIDAD DE MATERIALES Y ELABORACIÓN, RESPETANDO LAS NECESIDADES ERGONÓMICAS Y FUNCIONALES



FILOSOFIA | MISSION ARCHEDA

LA COERENZA DI QUESTA IDEA È DIMOSTRATA DALL'IMPORTANTE CRESCITA AVVENUTA IN QUESTI ULTIMI ANNI, IN TERMINE DI VOLUME DI AFFARI ED INNOVAZIONE TECNOLOGICA. LA PRODUZIONE DI MOBILI DA BAGNO, COMPLEMENTI ED ACCESSORI SI SVOLGE SU UNA SUPERFICIE DI 4000MQ, CON UNA RETE DISTRIBUTIVA COSTITUITA DA UN INSIEME DI PUNTI VENDITA SPECIALIZZATI NEL SETTORE

THE CONSISTENCY OF THIS IDEA IS DEMONSTRATED BY THE IMPORTANT GROWTH OVER THE LAST FEW YEARS, IN TERMS OF VOLUME OF BUSINESS AND TECHNOLOGICAL INNOVATION. THE PRODUCTION OF BATHROOM FURNITURE, ACCESSORIES AND ACCESSORIES TAKES PLACE ON AN AREA OF 4000 SQUARE METERS, WITH A DISTRIBUTION NETWORK CONSISTING OF A SET OF SPECIALIZED SHOPS IN THE INDUSTRY

LA COHÉRENCE DE CETTE IDÉE EST DÉMONTRÉE PAR LA CROISSANCE IMPORTANTE AU COURS DES DERNIÈRES ANNÉES, EN TERMES DE VOLUME D'AFFAIRES ET L'INNOVATION TECHNOLOGIQUE. LA PRODUCTION DE MEUBLES DE SALLE DE BAIN, ET LES ACCESSOIRES SE DÉROULE SUR UNE SUPERFICIE DE 4000 MÈTRES CARRÉS, AVEC UN RÉSEAU DE DISTRIBUTION CONSTITUÉ D'UN ENSEMBLE DE BOUTIQUES SPÉCIALISÉES DANS L'INDUSTRIE

DIE KONSISTENZ DIESER IDEE IST DURCH DEN WICHTIGEN WACHSTUMS IN DEN LETZTEN JAHREN IN BEZUG AUF DAS GESCHÄFTSVOLUMEN UND TECHNOLOGISCHE INNOVATION DEMONSTRIERT. DIE PRODUKTION VON BADMÖBEL, ACCESSOIRES UND ZUBEHÖR WIRD AUF EINE FLÄCHE VON 4000 QUADRATMETERN DURCHGEFÜHRT, MIT EINEM VERTRIEBSNETZ BESTEHEND AUS EINER REIHE VON FACHGESCHÄFTEN IN DER BRANCHE

LA COHERENCIA DE ESTA IDEA SE DEMUESTRA POR EL IMPORTANTE CRECIMIENTO EN LOS ÚLTIMOS AÑOS, EN TÉRMINOS DE VOLUMEN DE NEGOCIO E INNOVACIÓN TECNOLÓGICA. LA PRODUCCIÓN DE MUEBLES DE BAÑO, ACCESORIOS Y COMPLEMENTOS SE LLEVA A CABO EN UN ÁREA DE 4000 METROS CUADRADOS, CON UNA RED DE DISTRIBUCIÓN CONSTITUIDA DE UN CONJUNTO DE TIENDAS ESPECIALIZADAS EN EL SECTOR



LINEA pag. 6

**ANTA PIANA SQUADRATA CON MANIGLIA ALLUMINIO BORDO ANTA
SMOOTH, SQUARE DOOR WITH ALUMINIUM HANDLE ON DOOR EDGE
PORTE PLATE CARRÉE AVEC POIGNÉE EN ALUMINIUM SUR BORD DE LA PORTE
QUADRATISCHE FLACHE TÜR MIT ALUMINIUMGRIFF UND TÜRKANTE
PUERTA PLANA ESCUADRADA CON TIRADOR DE ALUMINIO EN EL CANTO**

**FIANCO STRUTTURALE IN FINITURA
FINISHED STRUCTURAL SIDE PANEL
CÔTÉ STRUCTUREL AVEC FINITION
STRUKTURSEITE IN DER AUSFÜHRUNG
COSTADO ESTRUCTURAL EN ACABADO**



TULLE pag. 70

**ANTA PIANA SQUADRATA BORDO INCLINATO
SQUARE PLAIN DOOR WITH SLOPING EDGE
PLEIN PORTE CARRÉE AVEC BORD INCLINÉ
VOLLTÜR MIT SCHRÄGER KANTE
PUERTA PLANA Y CUADRADA CON LADO INCLINADO**

**FIANCO FINITURA RIPORTATO SP 12 MM
ADDED SIDE PANEL TH. 12 MM IN FINISHING
CÔTÉ EN FINITION ÉP. 12 MM
WANGEN IN FERTIGUNG D. 12 MM
LADO DE ACABADO ESP. 12 MM ADJUNTO**

**GOLA STRUTTURALE ORIZZONTALE
HORIZONTAL STRUCTURAL GROOVE
GORGE STRUCTURELLE HORIZONTALE
HORIZONTALE STRUKTUR-RILLE
RANURA ESTRUCTURAL HORIZONTAL**



GOLA pag. 160

**ANTA PIANA SQUADRATA GOLA INTEGRATA
SQUARE PLAIN DOOR WITH GROOVE
PLEIN PORTE CARRÉE AVEC BORD INCLINÉ
VOLLTÜR MIT INTEGRIERTEM GRIFF
PUERTA PLANA Y CUADRADA CON TIRADOR ACANALADO INTEGRADO**

**FIANCO STRUTTURALE IN FINITURA
FINISHED STRUCTURAL SIDE PANEL
CÔTÉ STRUCTUREL AVEC FINITION
STRUKTURSEITE IN DER AUSFÜHRUNG
COSTADO ESTRUCTURAL EN ACABADO**

**SISTEMA
GOLA**



LINEA

LINEA SI UNISCE AI MODELLI TULLE E GOLA A COMPLETAMENTO DEL SISTEMA. LA MANIGLIA PROFILO IN ALLUMINIO IN FINITURA TITANIO E ALLUMINIO SATINATO SI PUÒ APPLICARE ALL'INTERA GAMMA DI DECORATIVI, LEGNI E COLORI LACCATI DELLA PRODUZIONE ARCHEDA, CREANDO COSÌ MOLTEPLICI COMBINAZIONI CROMATICHE TRA FRONTALI, GOLE E ACCESSORI E MANTENENDO UNA RIGOROSA PULIZIA ESTETICA

LINEA JOINS THE TULLE AND GOLA MODELS TO COMPLETE THE COLLECTION. THE ALUMINIUM PROFILE HANDLE IN TITANIO AND SATIN-FINISHED ALLUMINIO CAN BE APPLIED TO THE FULL RANGE OF DECORATIVE, WOOD AND LACQUERED COLOUR FINISHES MADE BY ARCHEDA. THIS CREATES A VAST RANGE OF POSSIBLE COLOUR COMBINATIONS FOR FRONT PANELS, GROOVES AND ACCESSORIES, WHILE KEEPING THE OVERALL LOOK CLEAN AND SLEEK

LINEA S'UNIT AUX MODÈLES TULLE ET GOLA AFIN DE COMPLÉTER LE SYSTÈME. LA POIGNÉE PROFIL EN ALUMINIUM DANS LA FINITION TITANIO ET ALUMINIUM SATINÉ PEUT ÊTRE APPLIQUÉE SUR TOUTE LA GAMME DE DÉCORATIONS, BOIS ET COLORIS LAQUÉS DE LA PRODUCTION ARCHEDA, EN CRÉANT AINSI DE MULTIPLES COMBINAISONS CHROMATIQUES ENTRE FAÇADES, GORGES ET ACCESSOIRES ET TOUT EN MAINTENANT UNE RIGOUREUSE NETTÉTÉ ESTHÉTIQUE

LINEA IST EINE ERGÄNZUNG ZU DEN MODELLEN TULLE UND GOLA UND VERVOLLSTÄNDIGT UNSER EINRICHTUNGSSYSTEM. DER ALUMINIUM-PROFILGRIFF IN DER AUSFÜHRUNG TITANIO UND SATINIERTEM ALLUMINIO KANN MIT DER GESAMTEN PALETTE DER VON ARCHEDA HERGESTELLTEN DEKOREN, HÖLZERN UND LACKIERTEN FARBEN KOMBINIERT WERDEN. ES ENTSTEHT EIN VIELFÄLTIGES FARBLICHES ZUSAMMENSPIEL ZWISCHEN FRONTEN, KEHLEISTEN UND ZUBEHÖR, DAS DEM RAUM EINE LINEARE ÄSTHETIK GIBT

LINEA SE UNE A LOS MODELOS TULLE Y GOLA PARA COMPLETAR EL SISTEMA. EL TIRADOR DE PERFIL DE ALUMINIO EN ACABADO TITANIO Y ALLUMINIO SATINADO ES COMPATIBLE CON TODA LA GAMA DE DECORACIONES, MADERAS Y COLORES LACADOS DE ARCHEDA, CREANDO ASÍ MÚLTIPLES COMBINACIONES CROMÁTICAS ENTRE FRENTES, GOLAS Y ACCESORIOS Y MANTENIENDO UNA ESTRICTA LIMPIEZA ESTÉTICA



**NODATO CANYON CON
PARTICOLARI LACCATI TITANIO E
MANIGLIA TITANIO, TOP GRES NOIR
DESIR OPACO SP. 6 CM CON VASCA
INTEGRATA "GG", SPECCHIO FILO
CON LAMPADA METRO**

**NODATO CANYON WITH TITANIO
LACQUERED DETAILS AND TITANIO
HANDLE. TH.6 CM GRES NOIR
DESIR MATT TOP WITH "GG"
INTEGRATED BASIN, FILO MIRROR
WITH METRO LAMP**

**NODATO CANYON AVEC DÉTAILS
ET POIGNÉE TITANIO. PLAN DE
TOILETTE ÉP. 6 CM EN GRES
NOIR DESIR MAT AVEC VASQUE
INTÉGRÉE "GG". MIROIR FILO AVEC
LAMPE METRO**

**NODATO CANYON MIT
DETAILS UND GRIFFE
TITANIO, WASCHTISCHPLATTE
GRES NOIR DESIR MATT ST. 6 CM
MIT INTEGRIERTEM BECKEN "GG".
SPIEGEL MOD.FILO UND LAMPE
MOD.METRO**

**NODATO CANYON CON DETALLES
Y TIRADOR TITANIO. ENCIMERA
DE GRES NOIR DESIR MATE ESP. 6
CM CON CUBA INTEGRADA "GG",
ESPEJO FILO Y LAMPARA METRO**

COMPOSIZIONE L-01 LINEA

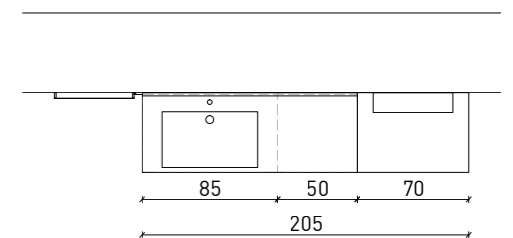
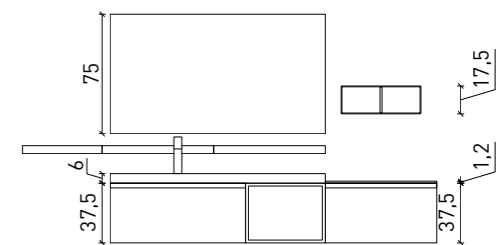



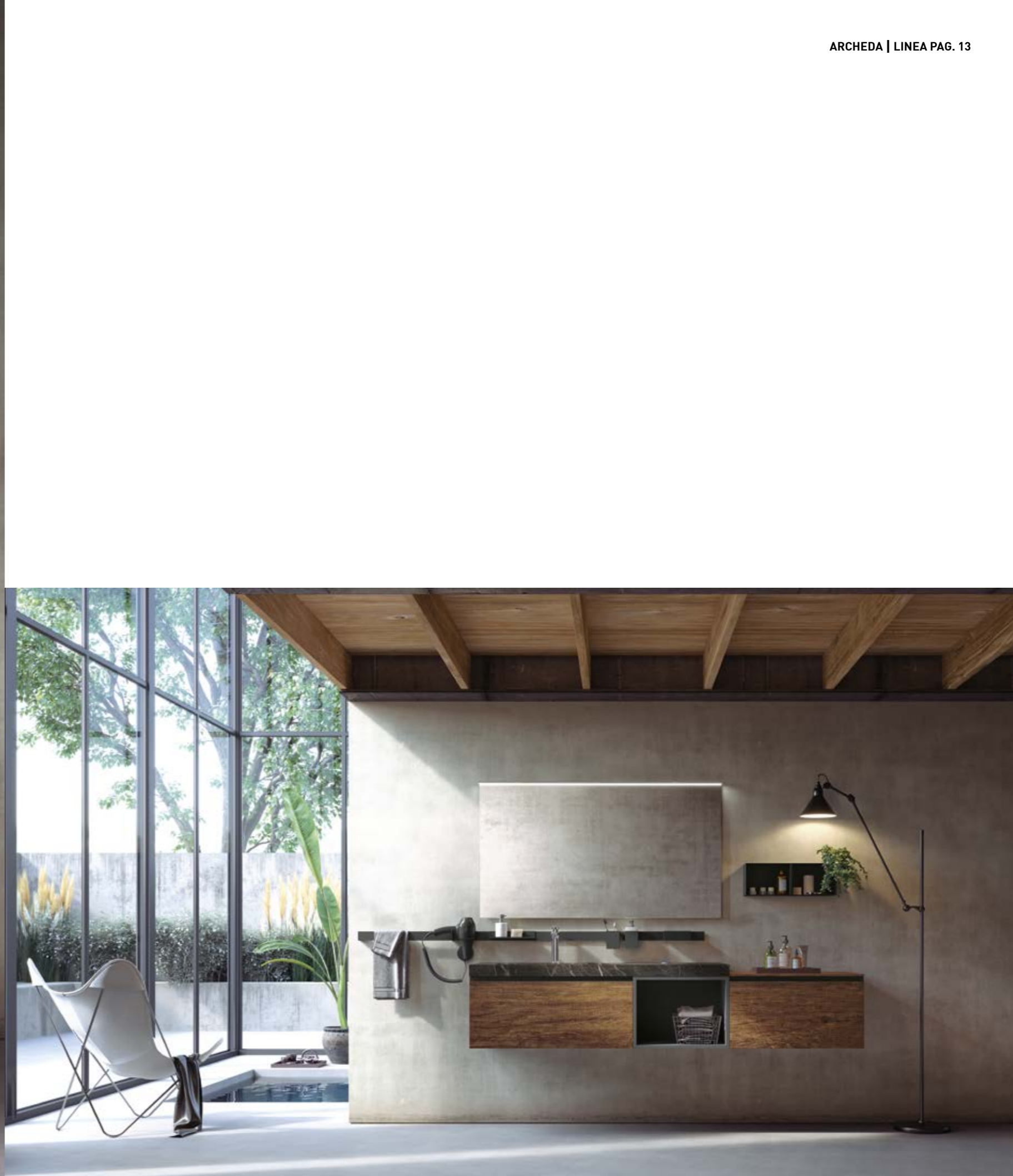





HPL ANTIQUE, MANIGLIA
 ALLUMINIO SATINATO, PENSILE
 ED ELEMENTI A GIORNO "SQUARE"
 LACCATI BIANCO OPACO. TOP HPL
 ANTIQUE SP. 10 CM CON VASCA
 INTEGRATA "HF", SPECCHIO MOON

HPL ANTIQUE, ALUMINIUM MATT
 HANDLE, LACQUERED BIANCO MATT
 WALL UNIT AND "SQUARE" OPEN
 ELEMENTS. TH. 10 CM HPL ANTIQUE
 TOP WITH "HF" INTEGRATED BASIN,
 MOON MIRROR

HPL ANTIQUE, POIGNÉE
 ALUMINIUM, ÉLÉMENT HAUT ET
 ÉLÉMENTS OUVERTS "SQUARE"
 BIANCO MAT. PLAN DE TOILETTE
 EN HPL ANTIQUE ÉP. 10 CM AVEC
 VASQUE INTÉGRÉE "HF",
 MIROIR MOON

HPL ANTIQUE MIT GRIFFE
 ALUMINIUM SATINIERT.
 WANDHÄNGESCHRANK UND
 OFFENE ELEMENTEN "SQUARE"
 LACKIERT BIANCO MATT.
 WASCHTISCHPLATTE HPL ANTIQUE
 ST. 10 CM MIT INTEGRIERTEM
 BECKEN "HF", SPIEGEL
 MOD. MOON

HPL ANTIQUE CON TIRADOR
 ALUMINIO, COLGANTE Y MÓDULOS
 ABIERTOS "SQUARE" BIANCO
 MATE. ENCIMERA DE HPL ANTIQUE
 ESP. 10 CM CON CUBA INTEGRADA
 "HF", ESPEJO MOON

COMPOSIZIONE L-02 LINEA

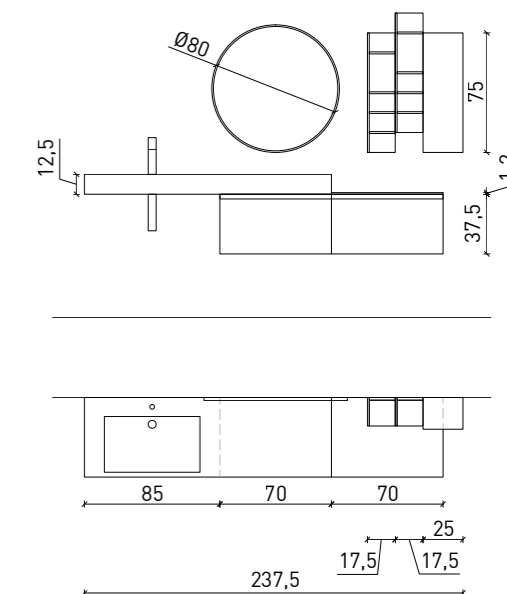







HPL TOBACCO 440 CON
PARTICOLARI E MANIGLIA TITANIO.
TOP HPL TOBACCO 440 SP. 6 CM
CON VASCA INTEGRATA "HH",
SPECCHIO MODULAR

HPL TOBACCO 440 WITH TITANIO
DETAILS AND HANDLE. TH. 6 HPL
TOBACCO 440 TOP WITH "HH"
INTEGRATED BASIN,
MODULAR MIRROR

HPL TOBACCO 440 AVEC DÉTAILS
ET POIGNÉE TITANIO. PLAN DE
TOILETTE EN HPL TOBACCO 440
ÉP. 6 CM AVEC VASQUE INTÉGRÉE
"HH", MIROIR MODULAR

HPL TOBACCO 440 MIT
DETAILS UND GRIFFE TITANIO.
WASCHTISCHPLATTE HPL
TOBACCO 440 ST.10 CM MIT
INTEGRIERTEM BECKEN "HH",
SPIEGEL MOD.MODULAR

HPL TOBACCO 440 CON DETALLES
Y TIRADOR TITANIO. ENCIMERA DE
HPL TOBACCO 440 ESP. 10 CM CON
CUBA INTEGRADA "HH",
ESPEJO MODULAR

COMPOSIZIONE L-03 LINEA

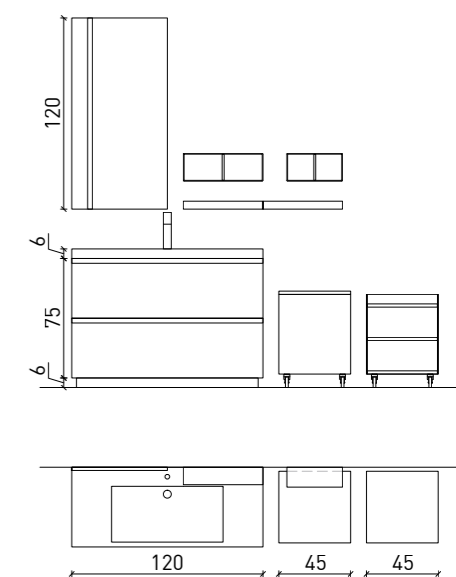









SKIN BIANCO CON MANIGLIA
TITANIO. TOP HPL CALYPSO 435
SP. 10 CM CON VASCA INTEGRATA
"HF", SPECCHIO FILO CON
LAMPADA METRO

SKIN BIANCO WITH TITANIO
HANDLE. TH. 10 CM HPL CALYPSO
435 TOP WITH "HF" INTEGRATED
BASIN, FILO MIRROR WITH
METRO LAMP

SKIN BIANCO AVEC POIGNÉE
TITANIO. PLAN DE TOILETTE EN
HPL CALYPSO 435 ÉP. 10 CM AVEC
VASQUE INTÉGRÉE "HF", MIROIR
FILO AVEC LAMPÉ METRO

SKIN BIANCO MIT GRIFFE TITANIO.
WASCHTISCHPLATTE HPL CALYPSO
435 ST. 10 CM MIT INTEGRIERTEM
BECKEN "HF". SPIEGEL MOD.FILO
UND LAMPE MOD.METRO

SKIN BIANCO CON TIRATOR
TITANIO. ENCIMERA DE HPL
CALYPSO 435 ESP. 10 CM CON CUBA
INTEGRADA "HF", ESPEJO FILO CON
LAMPARA METRO

COMPOSIZIONE L-04 LINEA

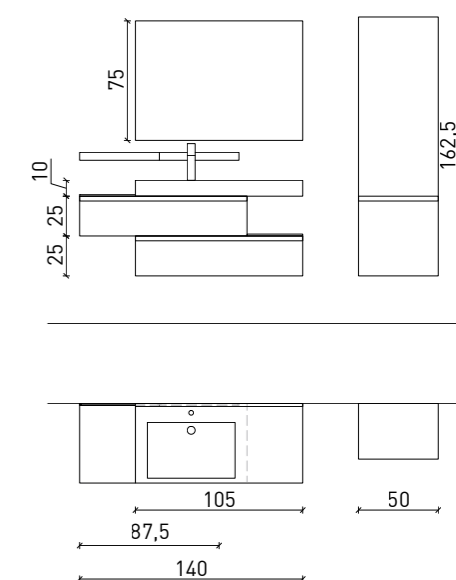









**NODATO SAVANA E TERRE ROMA
CON PARTICOLARI E MANIGLIA
TITANIO. TOP TERRE ROMA
SP. 6 CM, LAVABI SEMI-TRE-R,
SPECCHIO GAMMA E LAMPADE
TUBE IN METALLO NERO**

**NODATO SAVANA AND TERRE
ROMA WITH TITANIO DETAILS
AND HANDLE. TH. 6 CM TOP AND
"SEMI-TRE-R" BASIN TERRE ROMA
FINISHED. BLACK METAL GAMMA
MIRROR AND TUBE LAMPS**

**NODATO SAVANA ET TERRE ROMA
AVEC DÉTAILS ET POIGNÉE TITANIO.
PLAN DE TOILETTE ÉP.6 CM ET
VASQUE "SEMI-TRE-R" EN TERRE
ROMA. MIROIR GAMMA ET LAMPE
TUBE EN MÉTAL NOIR**

**NODATO SAVANA UND TERRE
ROMA MIT DETAILS UND GRIFFE
TITANIO. WASCHTISCHPLATTE
TERRE ROMA ST. 6 CM UND "SEMI-
TRE-R" BECKEN. SPIEGEL MOD.
GAMMA UND LAMPE MOD. TUBE IN
SCHWARTZ METALL**

**NODATO SAVANA Y TERRE ROMA
CON DETALLES Y TIRADOR TITANIO.
ENCIMERA EP. 6 CM Y CUBA "SEMI-
TRE-R" DE TERRE ROMA, ESPEJO
GAMMA Y LAMPARA TUBE**

COMPOSIZIONE L-05 LINEA

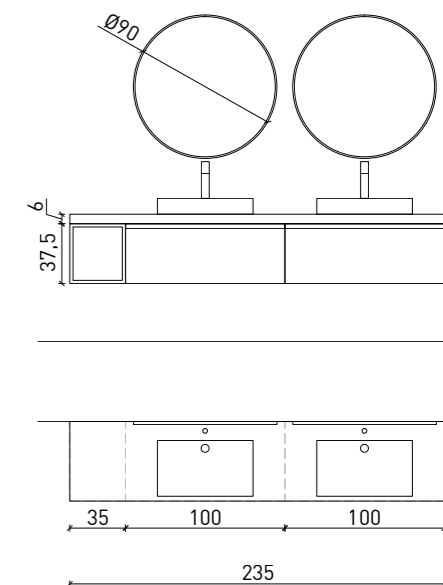









SKIN JEREZ, ELEMENTI A GIORNO
 SQUARE LACCATI BIANCO OPACO,
 MANIGLIA ALLUMINIO SATINATO.
 TOP TECNORIL CON VASCA
 INTEGRATA "H", SPECCHIO FILO
 CON LAMPADA CLIO SLIM

SKIN JEREZ, BIANCO MATT
 "SQUARE" OPEN ELEMENTS,
 ALUMINIUM MATT HANDLE.
 TECNORIL TOP WITH "H"
 INTEGRATED BASIN, FILO MIRROR
 WITH CLIO SLIM LAMP

SKIN JEREZ, ÉLÉMENTS OUVERTS
 "SQUARE" BIANCO MAT, POIGNÉE
 ALUMINIUM. PLAN DE TOILETTE
 EN TECNORIL AVEC VASQUE
 INTÉGRÉE "H", MIROIR FILO AVEC
 LAMPE CLIO SLIM

SKIN JEREZ, OFFENES ELEMENT
 "SQUARE" LACKIERT BIANCO MATT
 ,GRIFFE ALUMINIUM SATINIERT.
 WASCHTISCHPLATTE TECNORIL
 MIT INTEGRIERTEM BECKEN "H",
 SPIEGEL MOD.FILO UND LAMPE
 MOD.CLIO SLIM

SKIN JEREZ CON MÓDULOS
 ABIERTOS "SQUARE" BIANCO
 MATE, TIRADOR ALUMINIO.
 ENCIMERA DE TECNORIL CON
 CUBA INTEGRADA "H", ESPEJO
 FILO Y LAMPARA CLIO SLIM

COMPOSIZIONE L-06 LINEA

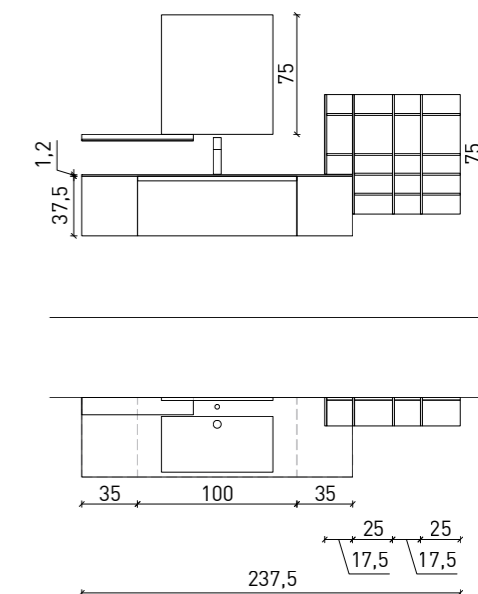









IMPIALLACCIATO OLMO CON PARTICOLARI HPL TOBACCO 440 E MANIGLIA TITANIO. TOP HPL TOBACCO 440 CON VASCA INTEGRATA "HH", SPECCHIO GAMMA E LAMPAD E TUBE IN METALLO NERO

OLMO VENEREED WITH HPL TOBACCO 440 DETAILS AND TITANIO HANDLE. HPL TOBACCO 440 TOP WITH "HH" INTEGRATED BASIN, BLACK METAL GAMMA MIRROR AND TUBE LAMPS

PLACAGE BOIS OLMO AVEC DÉTAILS EN HPL TOBACCO 440 ET POIGNÉE TITANIO. PLAN DE TOILETTE EN HPL TOBACCO 440 AVEC VASQUE INTÉGRÉE "HH", MIROIR GAMMA AVEC LAMPE TUBE EN MÉTAL NOIR

OLMO FURNIERT MIT DETAILS HPL TOBACCO 440 UND GRIFFE TITANIO. WASCHTISCHPLATTE HPL TOBACCO 440 MIT INTEGRIERTEM "HH" BECKEN. SPIEGEL MOD. GAMMA UND LAMPE MOD. TUBE IN METALL SCHWARTZ

CHAPA DE OLMO CON DETALLES DE HPL TOBACCO 440 Y TIRADOR TITANIO. ENCIMERA DE HPL TOBACCO 440 CON CUBA INTEGRADA "HH", ESPEJO GAMMA Y LAMPARAS TUBE DE METAL NEGRO MATE

COMPOSIZIONE L-07 LINEA

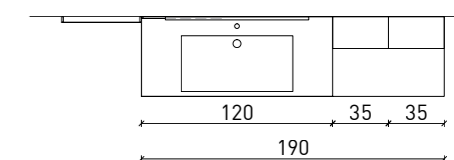
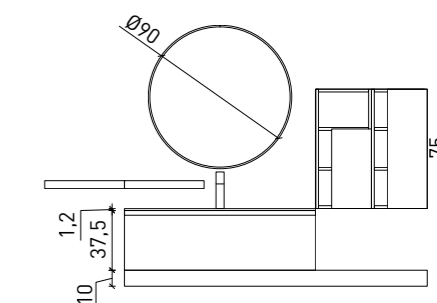









IMPIALLACCIATO ROVERE
FIAMMATO CASTAGNA CON
MANIGLIA TITANIO. LAVABO
SOSPESO MURO-TRE-R IN TERRE
OMBRA CON VANO A GIORNO
LATERALE, SPECCHIO MODULAR

CASTAGNA FIAMMATO OAK
VENEREED WITH TITANIO HANDLE.
TERRE OMBRA MURO-TRE-R WALL
MOUNTED BASIN WITH LATERAL
OPEN COMPARTMENT,
MODULAR MIRROR

PLACAGE CHÊNE FIAMMATO
CASTAGNA AVEC POIGNÉE TITANIO.
LAVABO SUSPENDU MURO-TRE-R
EN TERRE ROMA AVEC NICHE
OUVERTE LATÉRALE.
MIROIR MODULAR

FIAMMATO CASTAGNA EICHE
FURNIERT MIT GRIFFE TITANIO.
WANDHÄNGENDES WASCHBECKEN
TERRE OMBRA MURO-TRE-R MIT
SEITLICHEM OFFENEM FACH.
SPIEGEL MOD. MODULAR

CHAPA DE ROBLE FIAMMATO
CASTAGNA CON TIRADOR TITANIO.
CUBA SUSPENDIDA DE TERRE
OMBRA CON COMPARTIMENTO
LATERAL ABIERTO.
ESPEJO MODULAR

COMPOSIZIONE L-08

LINEA

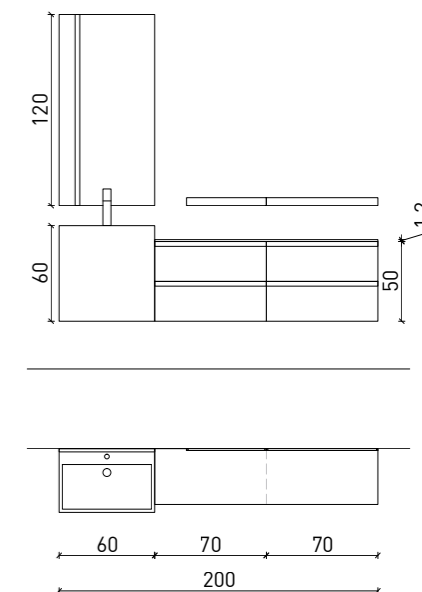









TULLE

TULLE, UN MOBILE CON GOLA STRUTTURALE PIATTA E FRONTALI PIANI CON BORDO INCLINATO, ESTREMAMENTE AGEVOLE E FUNZIONALE SI RINNOVA NELLA GAMMA DI DECORATIVI, LEGNI E COLORAZIONI LACCATE. LE FORME E I VOLUMI VENGONO REINTERPRETATI, OFFRENDO SOLUZIONI COMPOSITIVE E FUNZIONALI PER OGNI ESIGENZA

TULLE IS A UNIT WITH A FLAT STRUCTURAL GROOVE AND SMOOTH FRONT PANELS WITH AN INCLINED EDGE. THIS ULTRA-SIMPLE, FUNCTIONAL PIECE TAKES ON NEW LIFE IN THE NEW RANGE OF DECORATIVE, WOOD AND LACQUERED COLOUR FINISHES. THE SHAPES AND VOLUMES HAVE BEEN REVISITED, TO CREATE FUNCTIONAL COMPOSITIONS TO SUIT EVERY NEED

TULLE, UN MEUBLE AVEC GORGE STRUCTURELLE PLATE ET FAÇADES PLATES AVEC BORD INCLINÉ, EXTRÊMEMENT PRATIQUE ET FONCTIONNEL IL SE RENOUVELLE DANS LA GAMME DE DÉCORATIONS, BOIS ET COLORIS LAQUÉS. LES FORMES ET LES VOLUMES SONT RÉINTERPRÉTÉS, EN OFFRANT DES SOLUTIONS DE COMPOSITION ET FONCTIONNELLES À TOUTE EXIGENCE

TULLE IST MIT SEINER FLACHER KEHLELEISTE UND DEN FLACHEN FRONTEN MIT SCHRÄGER KANTE EIN ÄUSSERST UNKOMPLIZIERTES UND FUNKTIONALES MÖBELSTÜCK. DIE PALETTE AN DEKOREN, HÖLZERN UND LACKIERTEN FARBEN WURDE ERNEUERT UND SEINE FORMEN UND VOLUMEN NEU INTERPRETIERT UND BIETET NUN VIELFÄLTIG KOMBINIERBARE UND FUNKTIONELLE LÖSUNGEN FÜR JEDEN BEDARF

TULLE, UN MUEBLE CON GOLA ESTRUCTURAL PLANA Y FRENTES PLANOS CON CANTO INCLINADO, SUMAMENTE CÓMODO Y FUNCIONAL, SE RENUEDA CON LA GAMA DE DECORACIONES, MADERAS Y COLORES LACADOS. LAS FORMAS Y LOS VOLÚMENES RECIBEN NUEVAS INTERPRETACIONES, OFRECIENDO SOLUCIONES COMPOSITIVAS Y FUNCIONALES PARA CUALQUIER NECESIDAD



NODATO CANYON E HPL CALYPSO 435.
 TOP HPL CALYPSO 435 CON VASCA
 INTEGRATA "HH", SPECCHIO FILO CON
 ILLUMINAZIONE PERIMETRALE

**NODATO CANYON AND HPL CALYPSO
 435. HPL CALYPSO 435 TOP WITH "HH"
 INTEGRATED BASIN, FILO MIRROR WITH
 PERIMETRAL LIGHTING**

NODATO CANYON ET HPL CALYPSO 435.
 PLAN DE TOILETTE EN HPL CALYPSO 435
 AVEC VASQUE INTÉGRÉE "HH", MIROIR FILO
 AVEC ÉCLAIRAGE PÉRIMÉTRIQUE

NODATO CANYON UND HPL CALYPSO 435.
 WASCHTISCHPLATTE HPL CALYPSO 435 MIT
 INTEGRIERTEM BECKEN "HH", SPIEGEL MIT
 PERIMETRALEN-LED MOD. FILO

NODATO CANYON Y HPL CALYPSO 435.
 ENCIMERA DE HPL CALYPSO 435 CON
 CUBA INTEGRADA "HH". ESPEJO FILO CON
 ILUMINACIÓN EN EL PERÍMETRO

COMPOSIZIONE T-01 TULLE

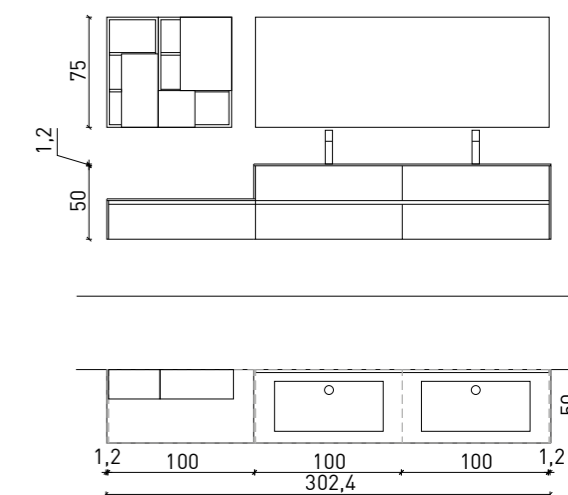



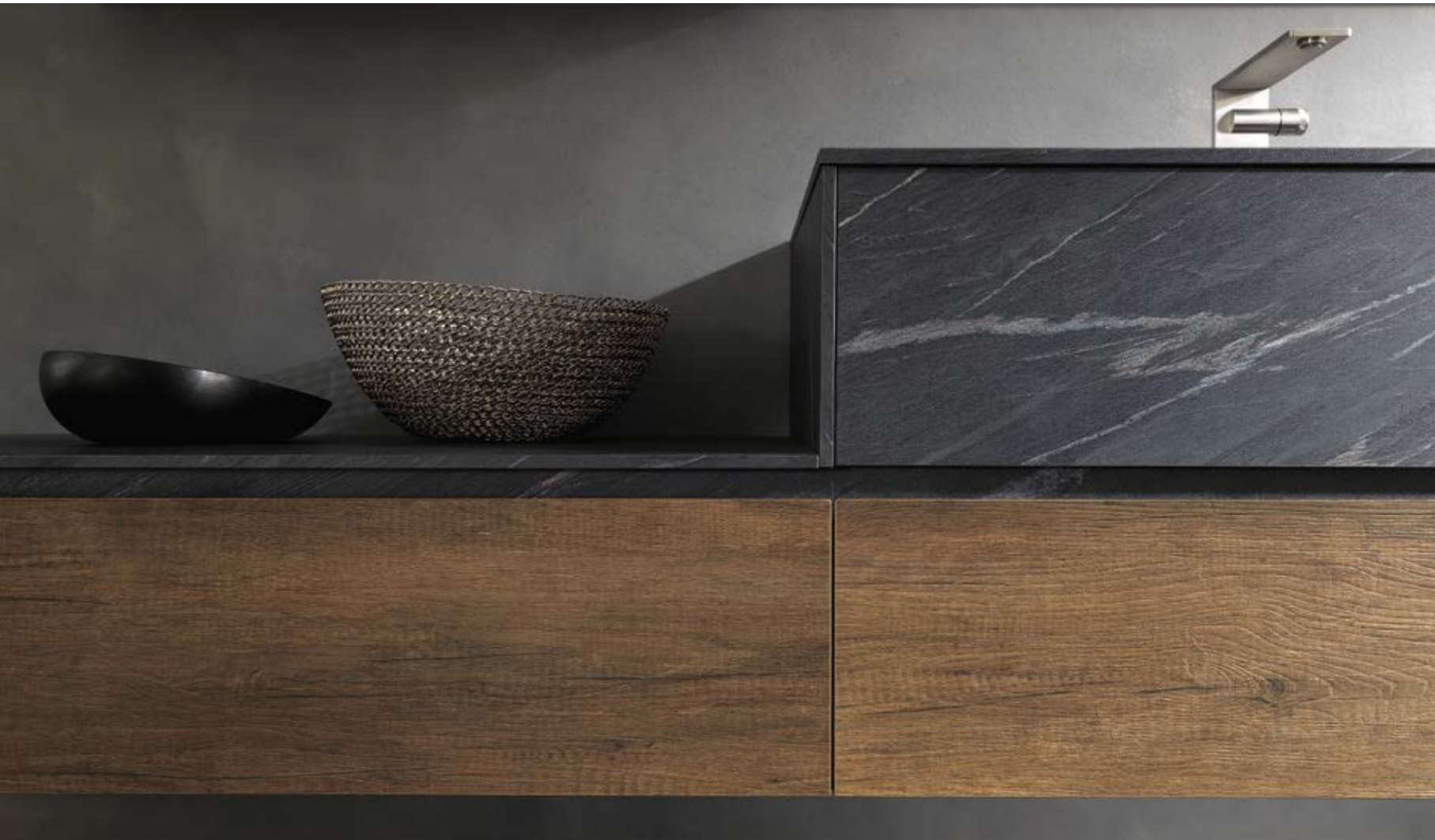





IMPIALLACCIATO NORDICO CAFFÈ E
LACCATO GIADA OPACO. TOP NORDICO
CAFFÈ CON LAVABO LADY IN TECNORIL,
SPECCHIO MOON

NORDICO CAFFÈ VENEREED AND GIADA
MAT LACQUERED. NORDICO CAFFÈ TOP
WITH TECNORIL LADY BASIN,
MOON MIRROR

PLACAGE CHÈNE NORDICO CAFFÈ ET
LACQUÉE GIADA MAT. PLAN DE TOILETTE
NORDICO CAFFÈ AVEC LAVABO LADY EN
TECNORIL. MIROIR MOON

NORDICO CAFFÈ EICHE FURNIERT UND
GIADA MATT LACKIERT. WASHTISCHPLATTE
NORDICO CAFFÈ MIT BECKEN MOD.LADY
TECNORIL. SPIEGEL MOD.MOON

CHAPA DE ROBLE NORDICO CAFFÈ Y
LACADO GIADA MATE. ENCIMERA DE
NORDICO CAFFÈ CON CUBA LADY DE
TECNORIL. ESPEJO MOON

COMPOSIZIONE T-02 TULLE

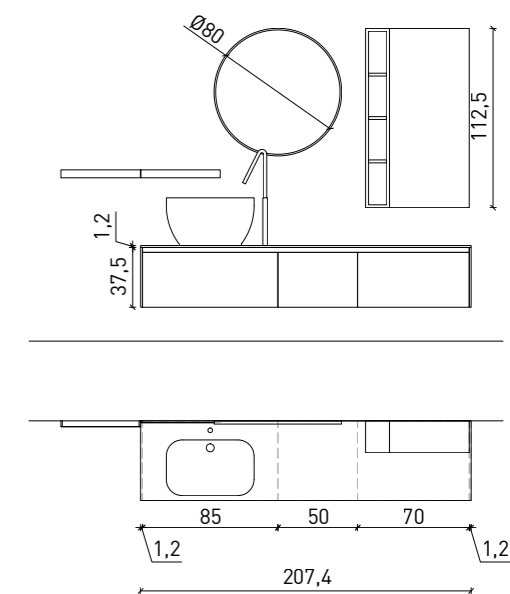









SKIN GRIGIO E BLU MOBY OPACO. TOP IN GRES PIETRA DI SAVOIA ANTRACITE CON VASCA INTEGRATA "GF", SPECCHIO FILO CON LAMPADA METRO

SKIN GRIGIO AND BLU MOBY MAT LACQUERED. GRES PIETRA DI SAVOIA TOP WITH "GF" INTEGRATED BASIN, FILO MIRROR WITH METRO LAMP

SKIN GRIGIO ET BLU MOBY MAT. PLAN DE TOILETTE EN GRES PIETRA DI SAVOIA ANTRACITE AVEC VASQUE INTÉGRÉE "GF". MIROIR FILO AVEC LAMPE METRO

SKIN GRIGIO UND BLU MOBY MATT LACKIERT. WASCHTISCHPLATTE GRES PIETRA DI SAVOIA ANTRACITE MIT INTEGRIERTEM BECKEN "GF". SPIEGEL MOD. FILO UND LAMPE MOD. METRO

SKIN GRIGIO E BLU MOBY. ENCIMERA DE GRES PIETRA DI SAVOIA ANTRACITE CON CUBA INTEGRADA "GF". ESPEJO FILO CON LAMPARA METRO

COMPOSIZIONE T-03 TULLE

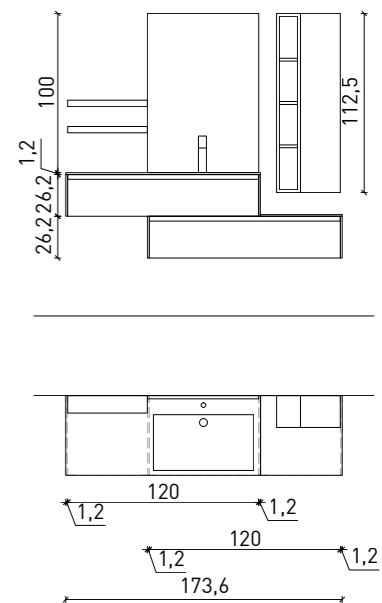







IMPIALLACCIATO EUCALIPTO AFFUMICATO
CON PARTICOLARI LACCATI NERO OPACO.
TOP GRES OSSIDO NERO CON LAVABO
ELITE NERO OPACO. SPECCHIO PROFILO
ALLUMINIO CON LAMPADA CLIO SLIM

EUCALIPTO AFFUMICATO VENEREED WITH
NERO MAT LACQUERED DETAILS. GRES
OSSIDO NERO TOP WITH BLACK MAT ELITE
BASIN. ALUMINIUM PROFILE MIRROR WITH
CLIO SLIM LAMP

PLACAGE EUCALIPTO AFFUMICATO AVEC
DÉTAILS NERO MAT. PLAN DE TOILETTE EN
GRES OSSIDO NERO AVEC LAVABO À POSER
ELITE NOIR MAT. MIROIR AVER PROFILS EN
ALUMINIUM AVEC LAMPE CLIO SLIM

EUCALIPTO AFFUMICATO FURNIERT
MIT DETAILS NERO MATT LACKIERT.
WASCHTISCHPLATTE GRES OSSIDO NERO
MIT BECKEN MOD.ELITE SCHWARTZ.
SPIEGEL MIT ALU-PROFIL MIT LAMPE MOD.
CLIO SLIM

CHAPA DE EUCALIPTO AFFUMICATO CON
DETALLES NERO MATE. ENCIMERA DE GRES
OSSIDO NERO CON CUBA ELITE NEGRA
MATE. ESPEJO CON PERFILES DE ALUMINIO
Y LAMPARA CLIO SLIM

COMPOSIZIONE T-04 TULLE

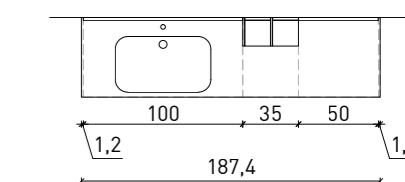
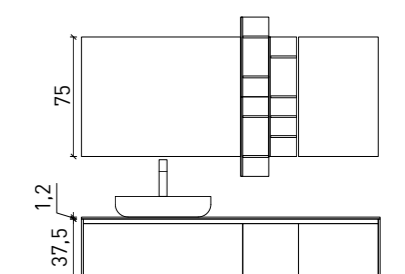







HPL PORFIDO 119, TOP HPL
PORFIDO 119 CON SOFTLY,
SPECCHIO FILO

HPL PORFIDO 119, HPL PORFIDO
119 TOP WITH SOFTLY BASIN,
MIRROR FILO

HPL PORFIDO 119, PLAN DE
TOILETTE EN HPL PORFIDO 119
AVEC VASQUE À POSER SOFTLY,
MIROIR FILO

HPL PORFIDO 119,
WASCHTISCHPLATTE HPL PORFIDO
119 MIT WASCHTISCH SOFTLY,
SPIEGEL FILO

HPL PORFIDO 119, ENCIMERA
DE HPL PORFIDO 119 CON CUBA
SOFTLY, ESPEJO FILO

COMPOSIZIONE T-06 TULLE

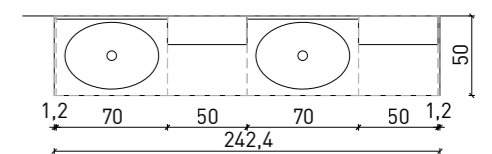
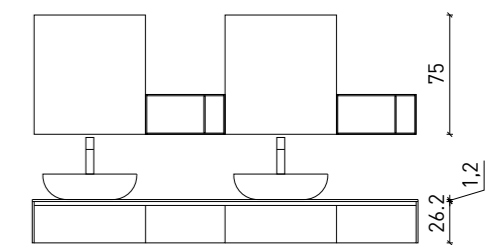









HPL ROVERE CASTORO 301 E
LACCATO BIANCO OPACO, TOP IN
TECNORIL CON VASCHE "F" E TOP
IN HPL ROVERE CASTORO 301.
SPECCHIO FILO

HPL ROVERE CASTORO 301 AND
MATT BIANCO LACQUERED,
TECNORIL TOP WITH "F" BASINS
AND HPL ROVERE CASTORO 301
TOP. MIRROR FILO

HPL ROVERE CASTORO 301 ET
LAQUÉ BIANCO MAT, PLAN DE
TOILETTE EN TECNORIL AVEC
VASQUES "F" ET EN HPL ROVERE
CASTORO 301. MIROIR FILO

HPL ROVERE CASTORO 301
UND BIANCO MATT LACKIERT,
WASCHTISCHPLATTE TECNORIL
MIT "F" BECKEN UND PLATTE
AUS HPL ROVERE CASTORO 301.
SPIEGEL FILO

HPL ROVERE CASTORO 301 Y
LACADO BIANCO MATE, ENCIMERAS
DE TECNORIL CON CUBA "F" Y
DE HPL ROVERE CASTORO 301.
ESPEJO FILO

COMPOSIZIONE T-07 TULLE

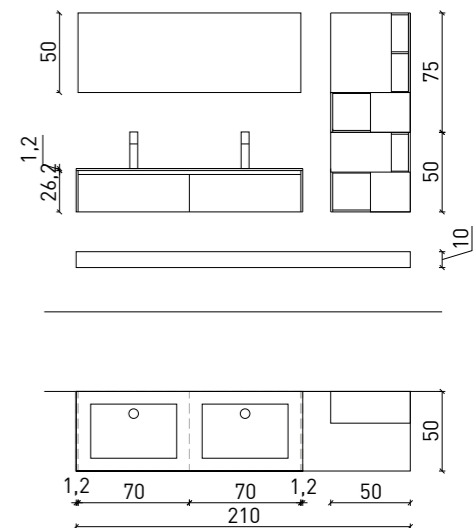









**NODATO LONDRA E LACCATO
BIANCO OPACO, TOP IN TECNORIL
CON VASCHE "H," SPECCHIO FILO
CON ILLUMINAZIONE PERIMETRALE**

**NODATO LONDRA AND BIANCO
MATT LAQUERED, TECNORIL TOP
WITH "H" INTEGRATED BASINS,
FILO MIRROR WITH
PERIMETRAL LIGHTING**

**NODATO LONDRA ET LAQUÉE
BIANCO MAT, PLAN DE TOILETTE
EN TECNORIL AVEC VASQUES "H",
MIROIR FILO AVEC
ÉCLAIRAGE PÉRIMÉTRIQUE**

**NODATO LONDRA UND
BIANCO MATT LACKIERT,
WASCHTISCHPLATTE TECNORIL
MIT INTEGRIERTEM BECKEN "H".
SPIEGEL MOD.FILO**

**NODATO LONDRA Y LACADO BIANCO
MATE, ENCIMERA DE TECNORIL
CON CUBAS "H", ESPEJO FILO CON
ILUMINACIÓN EN EL PERÍMETRO**

COMPOSIZIONE T-12 TULLE

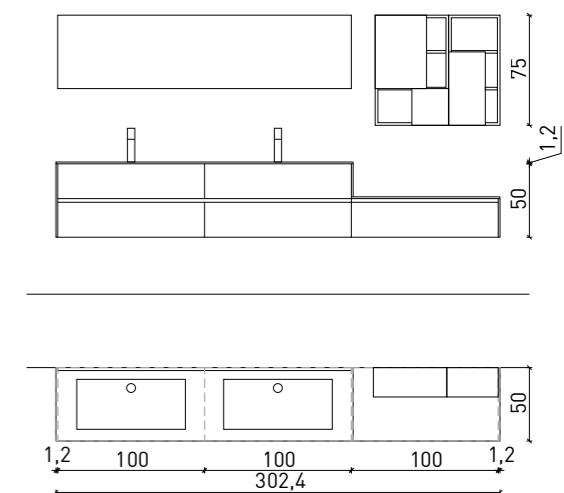









LACCATO BIANCO OPACO, TOP
TECNORIL CON VASCA INTEGRATA
H, SPECCHIO PROFILO ALLUMINIO E
LAMPADA CLIO SLIM

BIANCO MATT LAQUERED,
TECNORIL TOP WITH "H"
INTEGRATED BASIN, MIRROR WITH
ALUMINIUM PROFILE ANDA CLIO
SLIM LAMP

LAQUÉE BIANCO MAT, PLAN DE
TOILETTE EN TECNORIL AVEC
VASQUE "H", MIROIR ALUMINIUM
AVEC LAMPE CLIO SLIM

BIANCO MATT LACKIERT,
WASCHTISCHPLATTE TECNORIL
MIT INTEGRIERTEM BECKEN "H",
SPIEGEL ALUMINIUM MIT LAMPE
MOD.CLIO SLIM

LACADO BIANCO MATE, ENCIMERA
DE TECNORIL CON CUBA "H",
ESPEJO CON PERFILES DE
ALUMINIO Y LAMPARA CLIO SLIM

COMPOSIZIONE T-13 TULLE

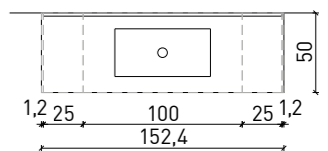
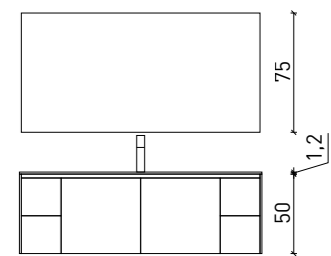







**OLMO COCCO E LACCATO CANAPA
OPACO, TOP IN VETRO EXTRA-
CHIARO CANAPA CON VASCA
INTEGRATA, SPECCHIO E
LAMPADA FILO**

**OLMO COCCO AND LACQUERED
CANAPA MATT, EXTRALIGHT
CANAPA GLASS TOP WITH
INTEGRATED BASIN, FILO MIRROR
AND LAMP**

**OLMO COCCO ET LAQUÉE CANAPA
MAT, PLAN DE TOILETTE EN VERRE
EXTRA-CLAIR CANAPA AVEC
VASQUE INTÉGRÉE, MIROIR ET
LAMPE FILO**

**OLMO COCCO UND CANAPA MATT
LACKIERT, WASCHTISCHPLATTE
GLAS CANAPA MIT INTEGRIERTEM
BECKEN, SPIEGEL UND LAMPE
MOD. FILO**

**OLMO COCCO Y LACADO CANAPA
MATE, ENCIMERA IN VIDRO CANAPA
CON CUBA FUNDIDA, ESPEJO Y
LAMPARA FILO**

COMPOSIZIONE T-14 TULLE

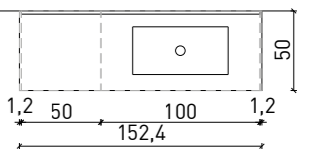
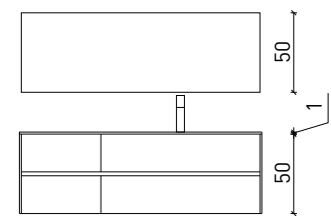



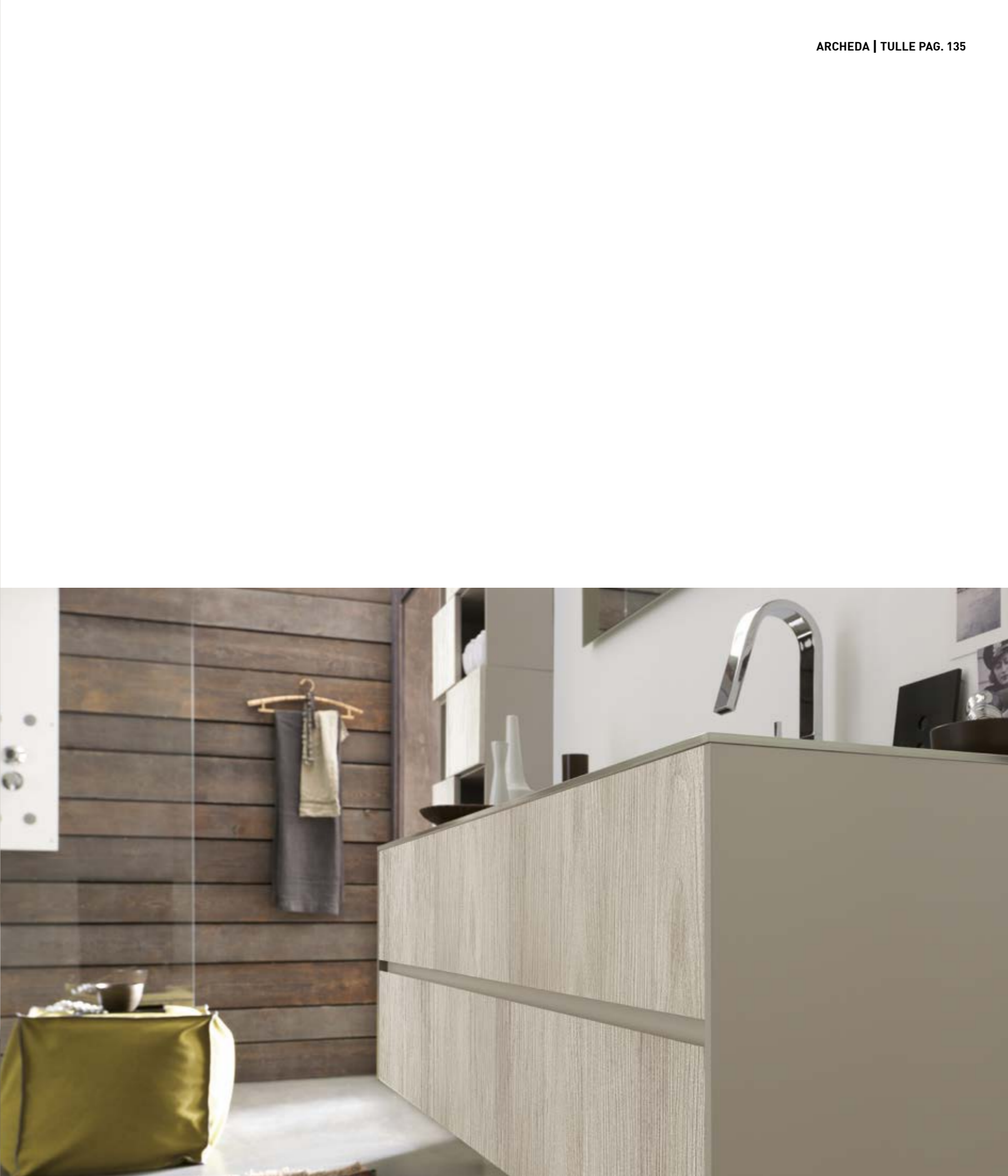



NORDICO CAFFÈ, PENSILI LACCATI
BIANCO OPACO, TOP NORDICO
CAFFÈ CON LAVABO IN TECNORIL
REGOLO, SPECCHIO FILO

NORDICO CAFFÈ, WALL ELEMENTS
MATT BIANCO LACQUERED,
NORDICO CAFFÈ TOP WITH
TECNORIL BASIN REGOLO,
MIRROR FILO

NORDICO CAFFÈ, ÉLÉMENTS HAUTS
LACQUÉE BIANCO MAT, PLAN DE
TOILETTE EN NORDICO CAFFÈ AVEC
LAVABO EN TECNORIL REGOLO,
MIRROIR FILO

NORDICO CAFFÈ,
WANDHÄNGESCHRÄNK
BIANCO MATT LACKIERTE,
WASCHTISCHPLATTE NORDICO
CAFFÈ MIT TECNORIL BECKEN
REGOLO, SPIEGEL FILO

NORDICO CAFFÈ, COLGANTES
LACADOS BIANCO MATE, ENCIMERA
DE NORDICO CAFFÈ CON CUBA EN
TECNORIL REGOLO, ESPEJO FILO

COMPOSIZIONE T-16 TULLE

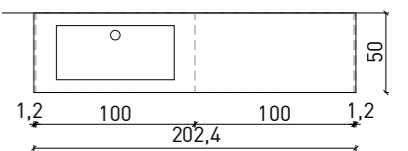
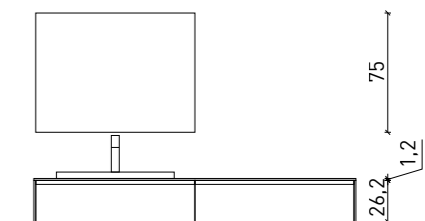









NORDICO CIOCCOLATO E
NATURALE, LAVABI BOX BIANCO
LUCIDO, SPECCHI CONTENITORI

NORDICO CIOCCOLATO AND
NATURALE, WHITE GLOSS BOX
BASINS, MIRRORS CABINET

NORDICO CIOCCOLATO ET
NATURALE, CONSOLES BOX
BLANC BRILLANT, MIROIRS AVEC
CONTENEURS

NORDICO CIOCCOLATO UND
NATURALE, WASCHTISCHPLATTE
BOX WEISS HOCHGLANZ,
SPIEGELSCHRÄNKE

NORDICO CIOCCOLATO Y
NATURALE, CONSOLAS BOX
BLANCO BRILLANTE, ESPEJOS
CONTENEDORES

COMPOSIZIONE T-17 TULLE

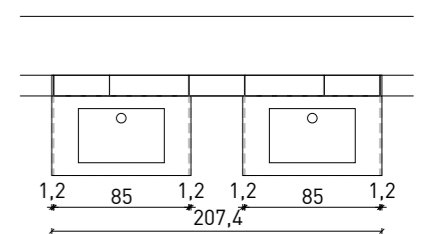
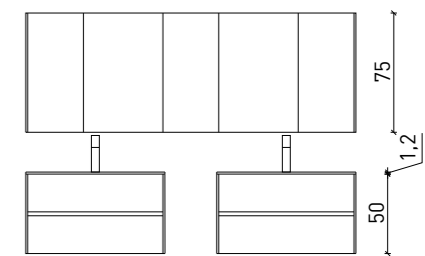









NODATO SAVANA E LACCATO
BIANCO OPACO, TOP NODATO
SAVANA CON LAVABO ELITE,
SPECCHIO E LAMPADA FILO

NODATO SAVANA AND MATT
BIANCO LACQUERED, NODATO
SAVANA TOP WITH ELITE BASIN,
MIRROR AND LAMP FILO

NODATO SAVANA ET LAQUÉE
BIANCO MAT, PLAN DE TOILETTE EN
NODATO SAVANA AVEC VASQUE À
POSER ELITE, MIROIR
ET LAMPE FILO

NODATO SAVANA UND
BIANCO MATT LACKIERT,
WASCHTISCHPLATTE NODATO
SAVANA MIT BECKEN MOD. ELITE,
SPIEGEL UND LAMPE MOD.FILO

NODATO SAVANA Y LACADO BIANCO
MATE, ENCIMERA DE NODATO
SAVANA CON CUBA EN CERAMICA
ELITE, ESPEJO Y LAMPARA FILO

COMPOSIZIONE T-18 TULLE

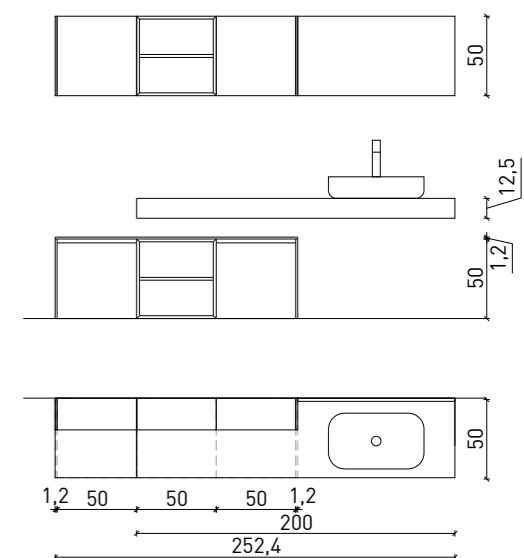









GOLA

GOLA, UN MODELLO SENZA TEMPO INTERPRETE DI UNO STILE CONTEMPORANEO, SI RINNOVA NELLA GAMMA DEI COLORI LACCATI E NEGLI ACCESSORI. DISPONE DI UNA SERIE DI ELEMENTI TERMINALI SFACCETTATI E DI RACCORDO, ESCLUSIVI ARCHEDA, STUDIATI PER CREARE SOLUZIONI COMPOSITIVE COMPATTE ED ALLO STESSO TEMPO DI FORTE IMPATTO ESTETICO

GOLA IS A TIMELESS MODEL THAT INTERPRETS CONTEMPORARY STYLE. IT HAS BEEN GIVEN A NEW LEASE OF LIFE IN THE RANGE OF LACQUERED COLOURS AND ACCESSORIES. AN ARRAY OF MULTI-SIDED AND CONNECTOR END UNITS, EXCLUSIVE TO ARCHEDA, HAVE BEEN DESIGNED TO CREATE COMPACT COMPOSITION SOLUTIONS THAT HAVE REAL VISUAL IMPACT

GOLA, UN MODÈLE HORS DU TEMPS ET INTERPRÈTE D'UN STYLE CONTEMPORAIN, SE RENOUVELLE DANS LA GAMME DES COLORIS LAQUÉS ET DANS LES ACCESSOIRES. IL DISPOSE D'UNE SÉRIE D'ÉLÉMENTS TERMINAUX FACETTÉS ET DE RACCORD, EXCLUSIFS ARCHEDA, CONÇUS POUR CRÉER DES SOLUTIONS DE COMPOSITION COMPACTES ET EN MÊME TEMPS AU FORT IMPACT ESTHÉTIQUE

GOLA IST ZEITLOS UND MODERN ZUGLEICH. DIE PALETTE AN LACKIERTEN FARBEN UND ZUBEHÖR WURDE ERNEUERT UND BIETET VIELFÄLTIGE ABSCHLUSS- UND VERBINDUNGSELEMENTE IM EXKLUSIVEN DESIGN VON ARCHEDA - FÜR KOMPACTE EINRICHTUNGSLÖSUNGEN MIT EINER STARKEN ÄSTHETISCHER WIRKUNG

GOLA, UN MODELO ATEMPORAL QUE TRANSMITE UN ESTILO CONTEMPORÁNEO, SE RENUENA CON LA GAMA DE COLORES LACADOS Y ACCESORIOS. DISPONE DE UNA SERIE DE ELEMENTOS TERMINALES DE UNIÓN CON FORMAS TALLADAS, EXCLUSIVOS DE ARCHEDA, ESTUDIADOS PARA CREAR COMPOSICIONES COMPACTAS Y, AL MISMO TIEMPO, DE MARCADO EFECTO ESTÉTICO



LACCATO CANAPA OPACO,
ELEMENTO A GIORNO LACCATO
GRAFITE OPACO, TOP DEIMOS
STONE TEXTURE SABBIA, LAVABO
INCA IN DEIMOS STONE SABBIA,
SPECCHIO PROFILO ALLUMINIO E
LAMPADA CLIO SLIM

CANAPA MATT LACQUERED,
GRAFITE MATT LACQUERED OPEN
ELEMENT, SABBIA DEIMOS STONE
TEXTURE TOP, SABBIA DEIMOS
STONE INCA BASIN, MIRROR WITH
ALUMINIUM PROFILE AND CLIO
SLIM LAMP

LAQUÉE CANAPA MAT, ÉLÉMENT
OUVERT LAQUÉE GRAFITE MAT,
PLAN DE TOILETTE EN DEIMOS
STONE TEXTURE SABBIA AVEC
LAVABO INCA EN DEIMOS STONE
SABBIA, MIROIR ALUMINIUM ET
LAMPE CLIO SLIM

CANAPA MATT LACKIERT, OFFENS
ELEMENT LACKIERT GRAFITE MATT,
WASCHTISCHPLATTE DEIMOS
STONE TEXTURE SABBIA MIT
BECKEN MOD. INCA DEIMOS STONE
SABBIA, SPIEGEL ALUMINIUM UND
LAMPE MOD. CLIO SLIM

LACADO CANAPA MATE, ELEMENTO
ABIERTO LACADO GRAFITE MATE,
ENCIMERA DE DEIMOS STONE
TEXTURE SABBIA CON CUBA INCA
DE DEIMOS STONE SABBIA, ESPEJO
CON PERFILES DE ALUMINIO Y
LAMPARA CLIO SLIM

COMPOSIZIONE G-01 GOLA

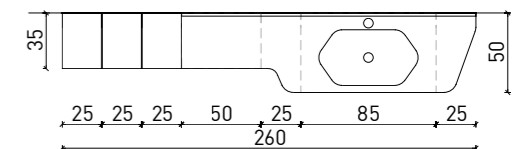
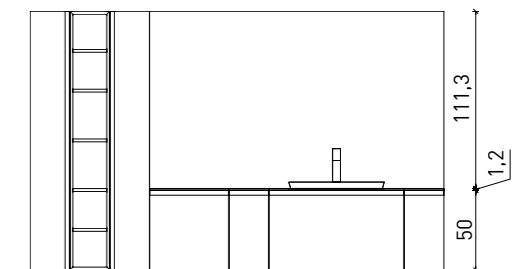









LACCATO BOSCO OPACO, TOP E
LAVABO MAYA IN DEIMOS STONE
TEXTURE BIANCO TRAFFICO.
SPECCHIO VINTAGE CON
LAMPADA SFERA

BOSCO MATT LACQUERED, BIANCO
TRAFFICO DEIMOS STONE TEXTURE
TOP ANDA AMYA BASIN. VINTAGE
MIRROR AND SFERA LAMP

LAQUÉE BOSCO MAT, PLAN DE
TOILETTE AVEC LAVABO À POSER
MAYA EN DEIMOS STONE TEXTURE
BIANCO TRAFFICO. MIROIR VINTAGE
ET LAMPE SFERA

BOSCO MATT LACKIERT,
WASCHTISCHPLATTE UND BECKEN
MOD. MAYA DEIMOS STONE
TEXTURE BIANCO TRAFFICO.
SPIEGEL MOD. VINTAGE UND
LAMPE MOD.SFERA

LACADO BOSCO MATE, ENCIMERA
Y CUBA MAYA DE DEIMOS STONE
TEXTURE BIANCO TRAFFICO.
ESPEJO VINTAGE Y LAMPARA SFERA

COMPOSIZIONE G-02

GOLA

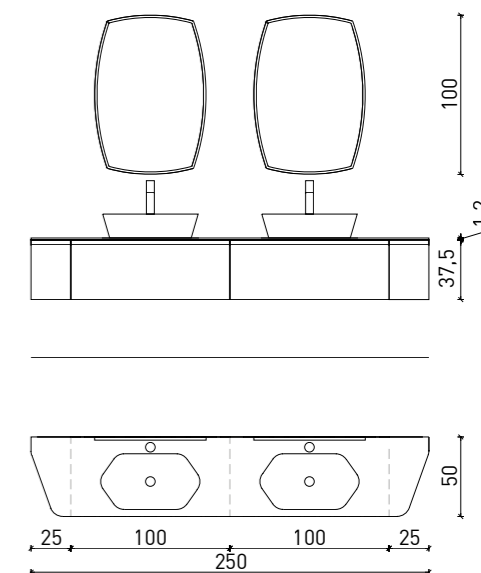







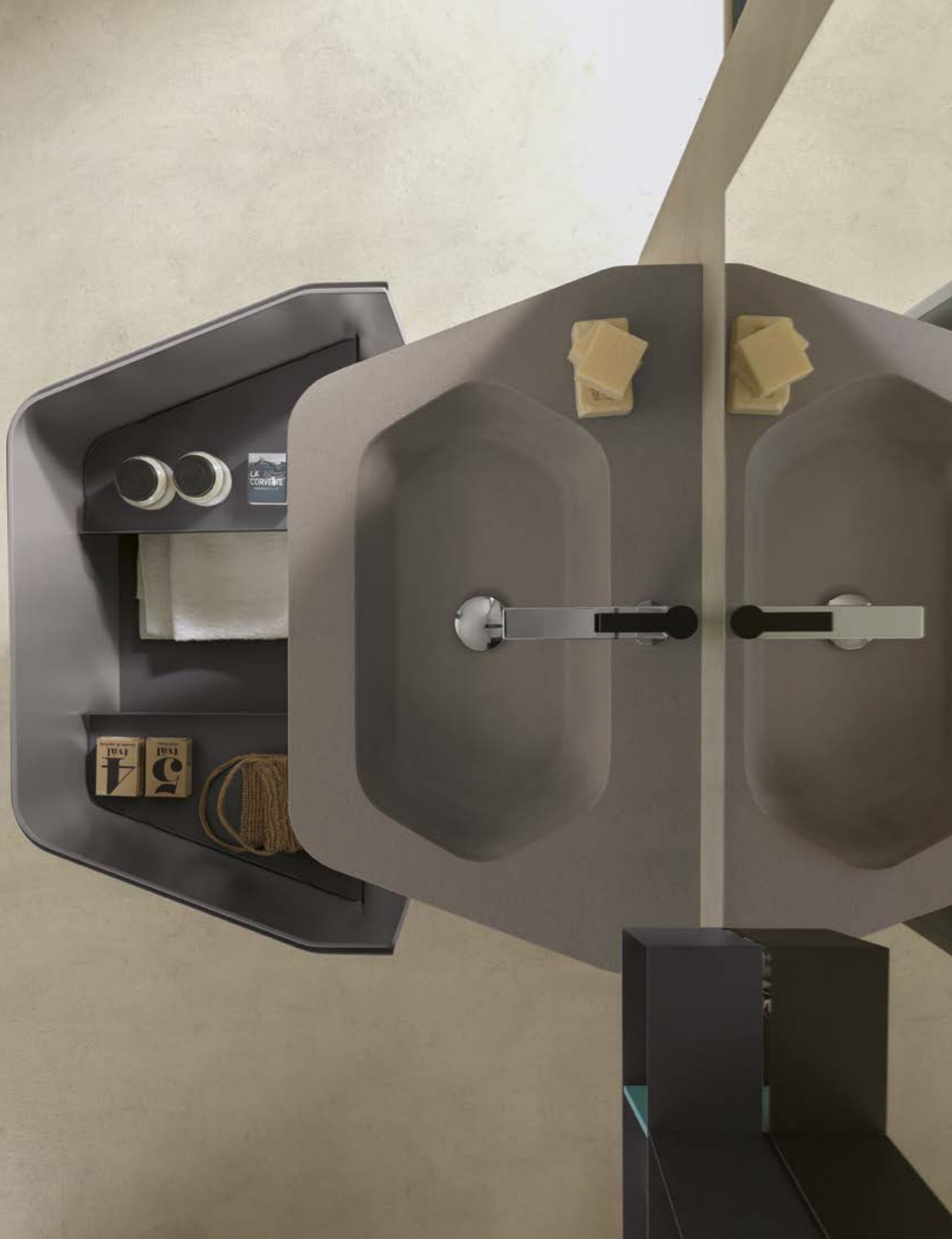

LACCATO FANGO OPACO E
TURCHESE OPACO, LAVABO
MONOBLOCCO ANDE IN DEIMOS
STONE TEXTURE TABACCO,
SPECCHIO FILO E LAMPADA METRO

FANGO AND TURCHESE MATT
LACQUERED, DEIMOS STONE
TEXTURE TABACCO ONE-PIECE
BASIN ANDE, FILO MIRROR WITH
METRO LAMP

LAQUÉE FANGO ET TURCHESE MAT,
CONSOLE ANDE EN DEIMOS STONE
TEXTURE TABACCO, MIROIR FILO
ET LAMPE METRO

FANGO UND TURCHESE MATT
LACKIERT, WASCHTISCHPLATTE
ANDE DEIMOS STONE TEXTURE
TABACCO, SPIEGEL MOD. FILO MIT
LAMPE MOD. METRO

LACADO FANGO Y TURCHESE
MATE, CONSOLA DE DEIMOS STONE
TEXTURE TABACCO ANDE, ESPEJO
FILO Y LAMPARA METRO

COMPOSIZIONE G-03 GOLA

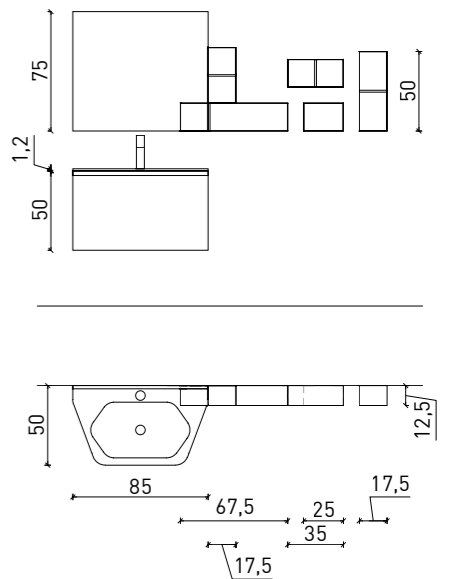









TERRE MASTICE CON TOP CON INSERTO DECORO CEMENTINE BOHO MINI MIX; LAVABO SEMI-TRE-R CON VASCA BETACRYL® E RIVESTIMENTO CEMENTINE BOHO MINI MIX. SPECCHIO FILO CON LAMPADA CLIO SLIM.ELEMENTI A GIORNO IN METALLO TITANIO E RETRO LACCATO GIADA OPACO

TERRE MASTICE WITH TOP WITH A CEMENTINE BOHO MINI MIX DECO INSERT; SEMI-TRE-R WASHBASIN WITH BETACRYL® AND CEMENTINE BOHO MINI MIX CLADDING. FILO MIRROR WITH CLIO SLIM LAMP; OPEN ELEMENTS IN TITANIO METAL AND MATT GIADA LACQUERED BACK PANEL.

TERRE MASTICE AVEC PLAN DE TOILETTE AVEC INSERT DÉCORATIF CEMENTINE BOHO MINI MIX ; LAVABO SEMI-TRE-R AVEC VASQUE BETACRYL® ET REVÊTEMENT CEMENTINE BOHO MINI MIX. MIROIR FILO AVEC LAMPE CLIO SLIM; ÉLÉMENT OUVERT FINITION TITANIO AVEC FOND GIADA MAT

TERRE MASTICE; PLATTE MIT DEKOREINSATZ CEMENTINE BOHO MINI MIX; WASHBECKEN SEMI-TRE-R MIT BECKEN IN BETACRYL® UND VERKLEIDUNG CEMENTINE BOHO MINI MIX. SPIEGEL MOD. FILO MIT LAMPE MOD.CLIO SLIM; OFFENES ELEMENT IN TITANIO MIT RÜCKWAND IN GIADA MATT

TERRE MASTICE. ENCIMERA CON DECORACIÓN INCRUSTADA CEMENTINE BOHO MINI MIX; LAVABO SEMI-TRE-R CON PILA BETACRYL® Y REVESTIMIENTO CEMENTINE BOHO MINI MIX. ESPEJOS FILO CON LAMPARA CLIO SLIM; ELEMENTO ABIERTO EN ACABADO TITANIO CON TRASERA GIADA MATE

COMPOSIZIONE G-04 GOLA

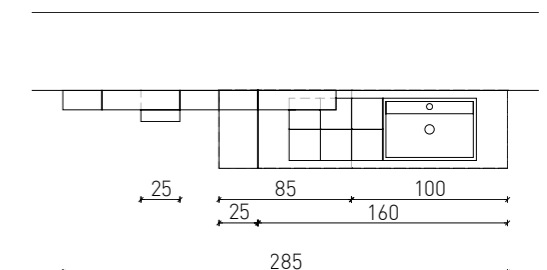
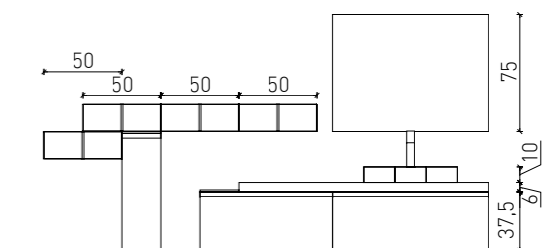









LACCATO CANAPA OPACO, TOP
TECNORIL CON VASCA INTEGRATA
"H", SPECCHIO FILO CON
LAMPADA METRO

CANAPA MATT LACQUERED,
TECNORIL TOP WITH "H"
INTEGRATED BASIN, MIRROR FILO
WITH METRO LAMP

LAQUÉE CANAPA MAT, PLAN DE
TOILETTE EN TECNORIL AVEC
VASQUE INTÉGRÉE "H", MIROIR
FILO AVEC LAMPÉ METRO

CANAPA MATT LACKIERT,
WASCHTISCHPLATTE TECNORIL
MIT INTEGRIETEM BECKEN "H",
SPIEGEL MOD. FILO MIT LAMPE
MOD. METRO

LACADO CANAPA MATE, ENCIMERA
DE TECNORIL CON CUBA
INTEGRADA "H", ESPEJO FILO CON
LÁMPARA METRO

COMPOSIZIONE G-05 GOLA

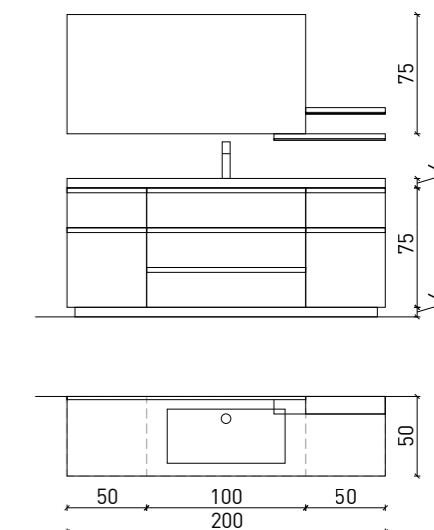









LACCATO CANAPA OPACO, TOP
GRES STRIATO OPACO CON VASCA
INTEGRATA "GJ", SPECCHIO LUNA

CANAPA MATT LACQUERED,
STRIAT MATT GRES TOP WITH "GJ"
INTEGRATED BASIN, MIRROR LUNA

LAQUÉE CANAPA MAT, PLAN DE
TOILETTE EN GRES STRIATO MAT
AVEC VASQUE INTÉGRÉE "GJ",
MIROIR LUNA

CANAPA MATT LACKIERT,
WASCHTISCHPLATTE GRES STRIATO
MATT MIT INTEGRIERTEM BECKEN
"GJ", SPIEGEL MOD. LUNA

LACADO CANAPA MATE, ENCIMERA
DE GRES STRIATO MATE CON CUBA
INTEGRADA "GJ", ESPEJO LUNA

COMPOSIZIONE G-08 GOLA

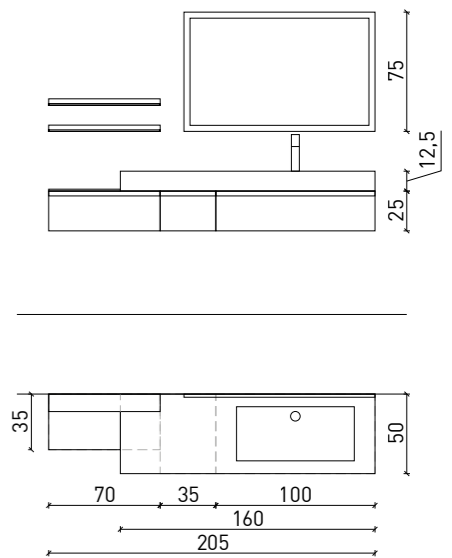







LACCATO BIANCO OPACO, SCHIENA
ELEMENTI A GIORNO IN VETRO E
TOP IN HPL OSSIDO 146, LAVABO
SKIN DOWN, SPECCHIO VINTAGE

BIANCO MATT LACQUERED, GLASS
OPEN ELEMENTS BACKS AND TOP
IN HPL OSSIDO 146, SKIN DOWN
BASIN, VINTAGE MIRROR

LAQUÉE BIANCO MAT, ÉLÉMENT
OUVERTES EN VERRE ET PLAN DE
TOILETTE EN HPL OSSIDO 146, SKIN
DOWN VASQUE, MIROIR VINTAGE

BIANCO MATT LACKIERTE,
RÜCKSEITEN DES OFFENE
WANDHÄNGESCHRANKE UND
WASCHTISCHPLATTE AUS HPL
OSSIDO 146, SKIN DOWN BECKEN,
SPIEGEL VINTAGE

LACADO BIANCO MATE, REVÉS DES
ELEMENTO ABIERTOS Y ENCIMERA
DE HPL OSSIDO 146 CON CUBA SKIN
DOWN, ESPEJOS VINTAGE

COMPOSIZIONE G-09 GOLA

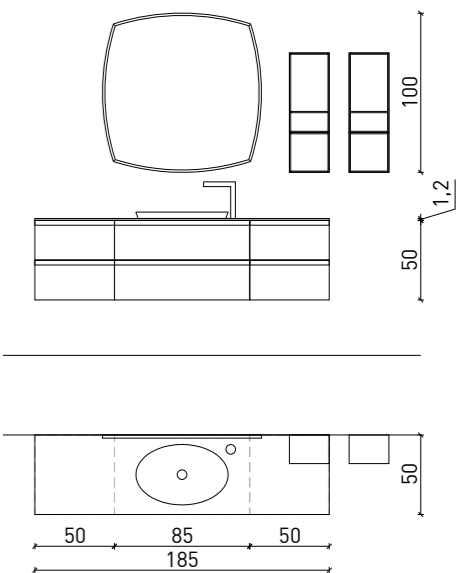

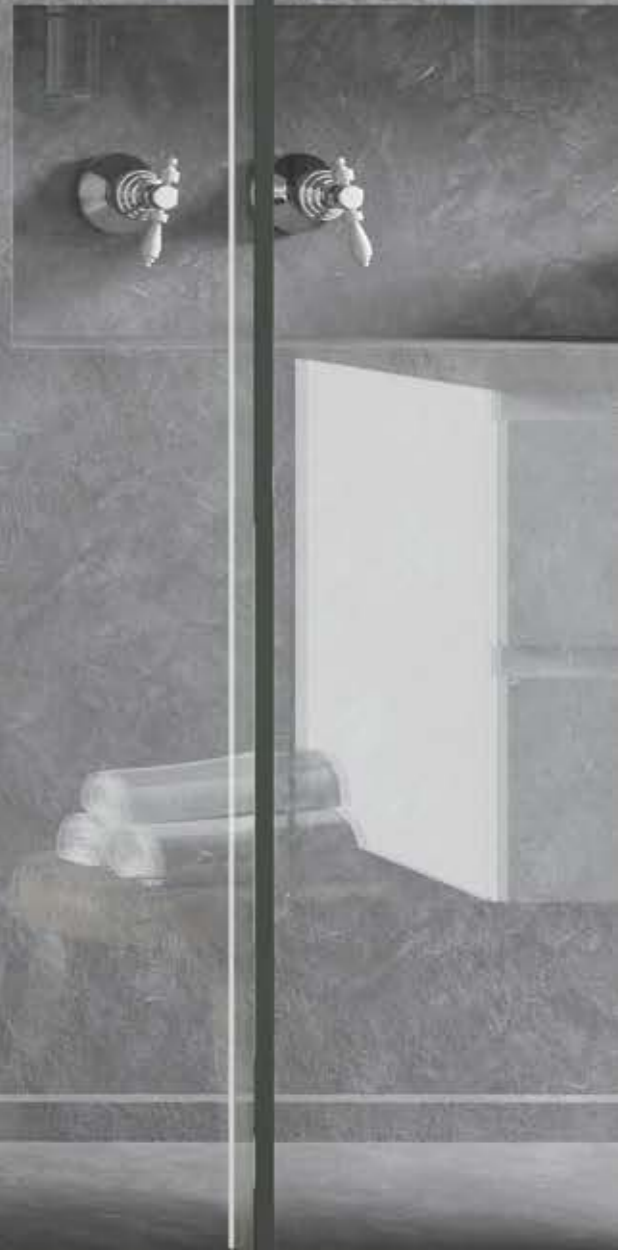





LACCATO OPACO NEI COLORI
CENERE, FANGO, CANAPA, JUTA
E POLVERE. TOP IN GRES OSSIDO
NERO CON LAVABO MILLERIGHE,
SPECCHIO VINTAGE

MATT LACQUERED IN THE COLORS:
CENERE, FANGO, CANAPA, JUTA
AND POLVERE. GRES OSSIDO NERO
TOP WITH MILLERIGHE BASIN,
VINTAGE MIRROR

LAQUÉE MAT DANS LES COULEURS
CENERE, FANGO, CANAPA, JUTA ET
POLVERE. PLAN DE TOILETTE EN
GRES OSSIDO NERO AVEC LAVABO
MILLERIGHE, MIROIR VINTAGE

CENERE, FANGO, CANAPA, JUTA
UND POLVERE MATT LACKIERT.
WASCHTISCHPLATTE GRES
OSSIDO NERO MIT BECKEN MOD.
MILLERIGHE, SPIEGEL
MOD. VINTAGE

LACADO MATE CENERE, FANGO,
CANAPA, JUTA Y POLVERE.
ENCIMERA DE GRES OSSIDO NERO
CON CUBA MILLERIGHE,
ESPEJO VINTAGE

COMPOSIZIONE G-11 GOLA

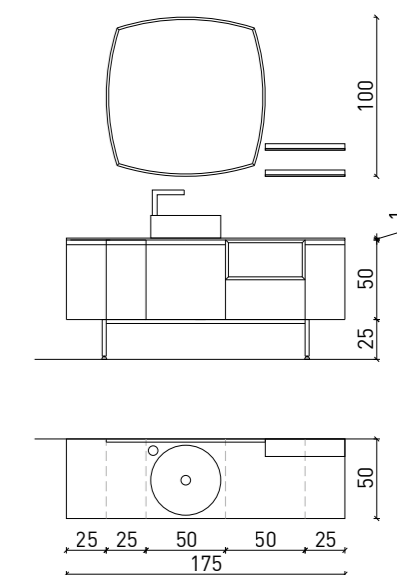







LACCATO BIANCO OPACO CON
BASE A GIORNO HPL BROWN 425.
TOP HPL BROWN 425 CON VASCA
INTEGRATA "ON" IN OCRITECH,
SPECCHIO LUNA

BIANCO MATT LACQUERED WITH
HPL BROWN 425 OPEN BASE UNIT.
HPL BROWN 425 TOP WITH "ON"
OCRITECH INTEGRATED BASIN,
LUNA MIRROR

LAQUÉE BIANCO MAT AVEC
ÉLÉMENT BAS OUVERT EN HPL
BROWN 425. PLAN DE TOILETTE
EN HPL BROWN 425 AVEC VASQUE
INTÉGRÉE EN OCRITECH "ON",
MIROIR LUNA

BIANCO MATT LACKIERT, OFFENES
UNTERSCHRANK HPL BROWN 425.
WASCHTISCHPLATTE HPL BROWN
425 MIT INTEGRIERTEM OCRITECH
BECKEN "ON", SPIEGEL MOD. LUNA

LACADO BIANCO MATE CON
MUEBLE BAJO ABIERTO DE HPL
BROWN 425. ENCIMERA DE HPL
BROWN 425 CON CUBA INTEGRADA
"ON" DE OCRITECH, ESPEJO LUNA

COMPOSIZIONE G-12 GOLA

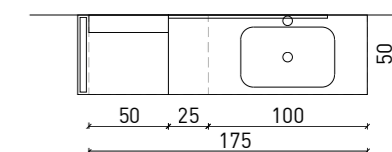
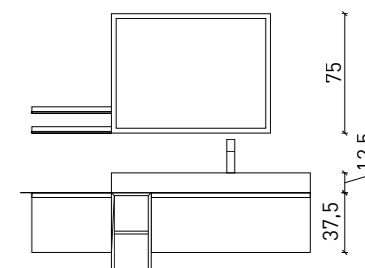





ACCESSORI STRIKE



BARRA



PORTASALVIETTE



MENSOLA

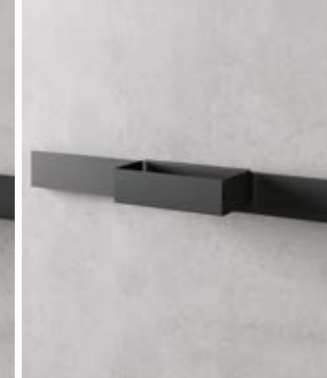

VASCHETTA



BICCHIERE - PORTASAPONE



PORTAPHON



PORTASMARTPHONE

ACCESSORI TRATTO



PORTASALVIETTE



APPENDINO



APPENDIABITO



PORTAROTOLO

ACCESSORI & FINITURE SISTEMA GOLA



LACCATO OPACO / LUCIDO
 MATT/GLOSS LACQUERED / LACQUÉE MAT ET BRILLIANT / MATT ODER GLÄNZEND LACKIERT / LACADO MATE Y BRILLO



LACCATO METAL (NO MOD. GOLA)
 METAL LACQUERED / LACQUÉ METAL / METAL LACKIERT / LACADO METAL



BIMELAMINICO SKIN (NO MOD. GOLA)
 BIMELAMINATED SKIN / BI-MÉLAMINÉ SKIN / BIMELAMIN SKIN / BI-MELAMINA SKI

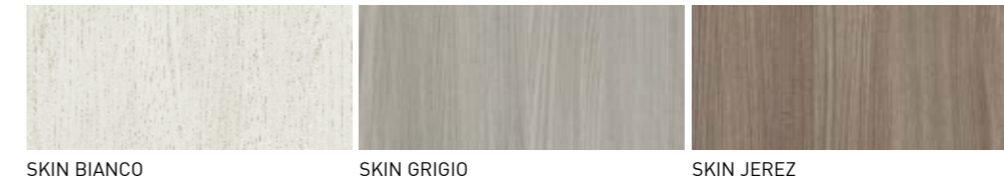

BIMELAMINICO SYNCRO (NO MOD. GOLA)
 BIMELAMINATED SYNCRO / BI-MÉLAMINÉ SYNCRO / BIMELAMIN SYNCRO / BI-MELAMINA SYNCRO



LEGNI (NO MOD. GOLA)

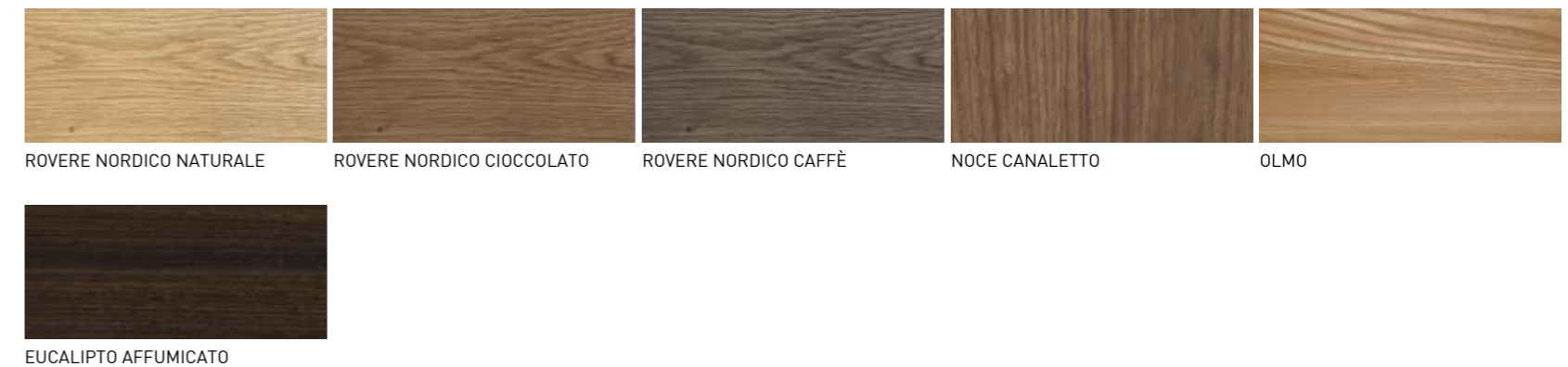

ROVERE FIAMMATO DECAPÉ (NO MOD. GOLA E TULLE)
 DECAPÉ FIAMMATO OAK / CHÊNE FIAMMATO DECAPÉ / DECAPÉ FIAMMATO EICHE / ROBLE FIAMMATO DECAPÉ



BIANCO PORO SCURO JUTA PORO BIANCO CANAPA PORO BIANCO FINESTRA PORO BIANCO POLVERE PORO BIANCO



AVIO PORO BIANCO

ROVERE FIAMMATO TINTO
 FIAMMATO OAK / CHÊNE FIAMMATO TEINTÉ / FIAMMATO EICHE / ROBLE FIAMMATO



AGATA CASTAGNA CORDA GRANO QUARZO



TARTUFO

ROVERE FIAMMATO LACCATO PORO APERTO (NO MOD. GOLA E TULLE)
 OPEN PORE LACQUERED FIAMMATO OAK / CHÊNE FIAMMATO LACQUÉ PORE OUVERT
 OFFEN PORIG LACKIERT FIAMMATO EICHE / ROBLE FIAMMATO LACADO PORO ABIERTO

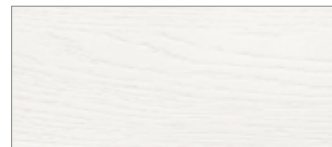

BIANCO



CAMPIONARIO ARCHEDA

HPL UNICOLOR (NO MOD. GOLA)



STATUARIO S. T. 439 CEMENTO 143 OLMO SCURO 303 OLMO BIONDO 134 ROVERE MONET 423



ROVERE TEXAS 306 ROVERE VERSAILLES 418 ROVERE CASTORO 301 SASSO 139 BASALTO 403



PORFIDO 119 OSSIDO 146 ARDESIA 145 MALTA BIANCA 430 MALTA GRIGIA 431



MALTA CANAPA 432 ANTIQUE BOTTICINO 410 CUMA DARK 428 CALYPSO 435

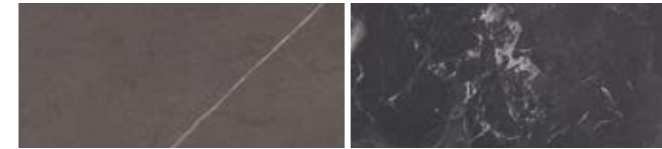

TOBACCO 440 IMPERO 438

FENIX (NO MOD. GOLA)



GRIGIO EFESO 725 VERDE COMODORO 750 BLU FES 754



BIANCO 32 NERO 720 BIBER 717 BROMO 724 GRIGIO 718

CATALOGUE PLANNIG
Maurizio Poletto

DESIGN E A.D.
Dario Poles

GRAPHIC DESIGN CATALOGO
Graphosds

FOTOGRAFIA
Gabriotti Fotografi

FOTOLITO E STAMPA
graficheitalprint.it

MARZO 2021

Archeda, al fine di migliorare le caratteristiche tecniche e qualitative della sua produzione, si riserva di apportare, anche senza preavviso, tutte le modifiche che si rendessero necessarie.

To improve the technical and the qualitative characteristics of the production, Archeda reserves the right to make all the suitable modifications without previous notice.

A fin daméliorer les caractéristiques techniques et qualitatives de sa production, la société Archeda se réserve le droit d'apporter, même sans preavis, toutes les modifications qui seront jugées nécessaires.

Um technische und qualitative Merkmale der Produktion zu verbessern, behält sich Archeda vor, alle nötige Abänderungen, ohne Avisierungen, vorzunehmen.

Archeda, a fin de mejorar las características técnicas y cualitativas de su producción, se reserva el derecho de aportar, incluso sin previo aviso, todas las modificaciones necesarias.



ARCHEDA s.r.l. via A. Malignani, 7 33080 Porcia (Pn) www.archeda.eu