

**único**

meubles  
de salle  
de bain

coycama

coycama

## Innovation.

Notre vision de l'avenir, c'est d'être une entreprise dynamique et compétitive, capable de s'adapter aux changements constants de la société moderne. Notre investissement continu dans la technologie et le développement permettent d'atteindre nos objectifs, mais aussi d'être une entreprise flexible avec une grande capacité de production.

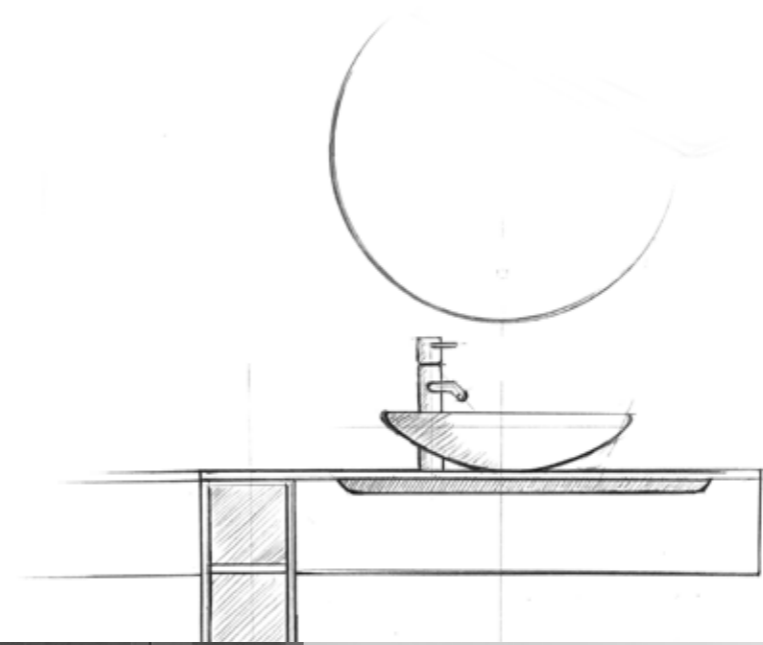

## Caractère.

Conception, fonctionnalité et qualité. La philosophie Coycama est simple: réussir un produit avec son propre style et sa personnalité.

Le chemin que nous parcourons a commencé voilà plus de 40 ans. Apprentissage. Sacrifice. Passion. Ce sont quelques unes des valeurs que nous avons assumées comme étant les nôtres tout au long de ce voyage. Chaque jour, nous travaillons afin de créer les meilleurs produits, en transmettant un peu de nous dans tout ce que nous faisons. Nous voulons être fiers de faire partie de votre maison.



**coycama**  
bathroom furniture

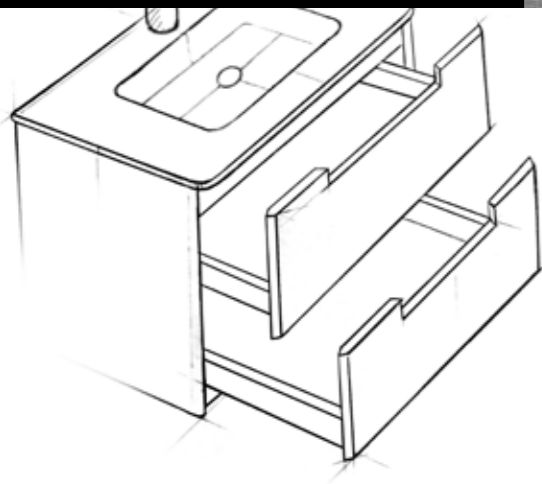

## Excellence.

Coycama se caractérise par la détermination sans faille de développer et fabriquer les meilleurs produits. Le design, le choix de matériaux et les contrôles de qualité font partie d'un processus de production complexe et en constante amélioration, qui a obtenu la certification ISO 9001, le label d'excellence attribué par l'Organisation Internationale pour la Normalisation.

## Horizon.

La qualité de nos produits et le professionnalisme d'un département spécialisé ont permis la reconnaissance internationale, en exportant dans plus de 50 pays à travers le monde.



# Index.



**landes.** 60 / 70 / 80 / 100 / 120  7



**landes.** MODULAR 60 - 200  31



**sigma.** 80 / 100 / 120 / 140  89



**omega.** 60 / 80 / 100 / 120  101



**berlín.** 60 / 70 / 80 / 100  113



**lúxor.** 80 / 100  125



**toscana.** 60 / 80 / 100  135



**flow.** 60 / 70 / 80 / 100 / 120 / 140  145



**ambar.lip** Solid surface 70 / 80 / 100 / 120 152



**epsilon.** 60 / 80 / 100 / 120 20 couleurs disponibles 159



**oslo.** 70 / 80 / 100 / 120  167



**praga.** 60 / 70 / 80 / 100 / 120  179



**hole.** 80 / 90 / 100  191



**galsaky.** 60 / 70 / 80 / 100  199



**galsaky.** INDUSTRIAL 60 / 70 / 80 / 100 / 120  213



**escorpio.** 60 / 70 / 80 / 100  223



**cervino.** 70 / 80 / 90 / 100  233



**comet.** 60 / 70 / 80  243



**berna.** 50 / 60  251



**siena.** 70 / 80  254



**versa.** 45 / 55  259



**stone.compact** 267  
**stone.tec**

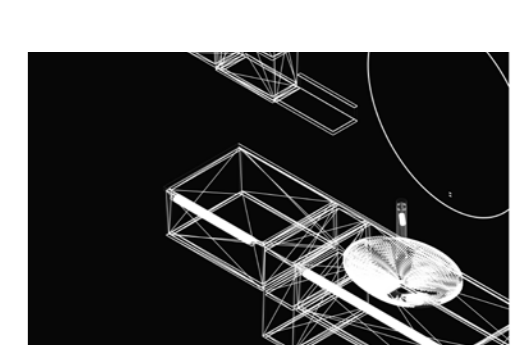

**spécification techniques** 279



Résistant à l'eau.  
Resistant to water.



# landes.

60 / 70 / 80 / 100 / 120



# landes.

MODULAR



# landes.

- Glissières métalliques. Metal interior drawers. Sistema di estrazione metallico. Metallizierleiste. Metalen zijkanten. درج معدني
- Extraction e. extraction. Estrazione e. Komplet herausziehbar. Volledig uittrekbaar. لمآك جرد حرتف ماظن
- Fermeture ralentie. Soft close. Frenata soft close. Sanifter Verschluss. Zachtsluitend. نظام إغلاق التوماتيكي
- Organisateur. Organizer unit. Organizzatore. Obere Ablage. Superieure organizer. منظم درج علوي
- Glissières Hettich. Hettich sliding system. Guide Hettich. Korpussschiene Hettich. Hettich lade system. مفصلات الجارية هتيتش
- Mélamine structurée. Textured melamine. Melamina testurizzata. Textur mit Relief. Reliefstructuur. ملمس منقوش
- Résistant à l'eau. Resistant to water. Idrorepellente. Wasserfest. مقاوم للماء

Résistant à l'eau. Resistant to water.

PREMIUM QUALITY ★★★★★



## comment commander exemple

how to do an order? example

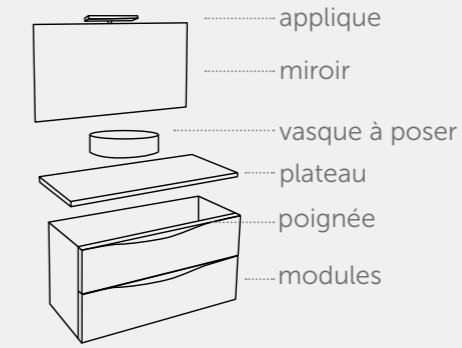

## les références

112 35 080  
modèle / model    couleur / color    Mesurer et variante / measure / variant

### Choisissez les modules / Choose the modules

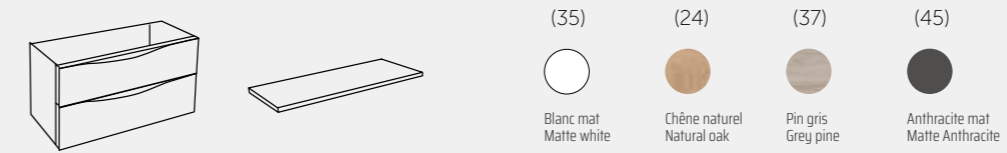

1

1	112 35 080	Module 2 tiroirs
1	112 35 208	Plateau Landes
	Poignée	Bend / Blanc

### Choisissez le poignée et la couleur / Choose model and color of the handles



2

ne pas oublier / don't forget

1	112 35 208	Plateau Landes
	420 27 000	Bend / Blanc
1	507 01 004	Rotterdam

### Choisissez le plans vasque / vasque à poser- / Choose washbasin



3

	Poignée	Bend / Blanc
1	507 01 004	Rotterdam
1	204 00 060	Sun 70x80

### Choisissez le miroir / Choose mirror



4

1	507 01 004	Rotterdam
1	204 00 080	Sun 80x80
1	400 14 161	Nerea mat 30

### Choisissez l'applique / Choose spotlights



5

1	204 00 060	Sun 70x80
1	400 14 161	Nerea mat



Nouvelle génération de panneaux plus résistant à l'eau.

new generation of more water resistant panels.



Système d'extraction de tiroir.

Drawers with extraction system.

Poignées ○ Blanc ● Chrome ● Noir

## 3 poignées et 3 couleurs en option

Bend



Tilt



Line







Glissières métalliques. Metal interior drawers. Sistema di estrazione metallico. Metallzierleiste. Metalen zijkanten. درج معدني



Extraction e. extraction. Estrazione e. Komplet herausziehbar. Volledig uittrekbaar. لமாக چرد حتف ماظن



Fermeture ralentie. Soft close. Frenata soft close. Sanfter Verschluss. Zachtsluitend. نظام إغلاق أوماتيكي



Organisateur. Organizer unit. Organizzatore. Obere Ablage. Superieure organizer. منظم درج علوي



Glissières Hettich. Hettich sliding system. Guide Hettich. Korpuschiene Hettich. Hettich lade system. مفصلات المانية هيتش



Mélangine structurée. Textured melamine. Melamina testurizzata. Textur mit Relief. Reliefstructuur. ملمس منقوش



Résistant à l'eau. Resistant to water. Idrorepellente. Wasserfest. Waterafstotend. مقاوم للماء



Système anti buée. Anti fog system. Sistema antiappannamento. Anti Beschlag System. نظام ضد الضباب



Lumière ambiant. Ambient light. Luce ambiente. Ambient Light. اضاءة خلفية



Capteurs de contact. Contact sensor On/Off. Sensore di con tatto On/Off. Sensorschalter On/Off. Aanraken Schakelaar. حساس لمس اطفاء / تشغيل



Réversible. It is reversible. Reversibile. Umkehrbar. Omkeerbaar. ja استعمال عكسي



Line



Tilt



Bend

poignées / handles



blanc



chrome



noir

# landes.60

Résistant à l'eau.  
Resistant to water.

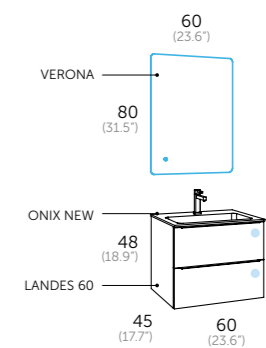

Composition | pin gris

1	112 37 060	<b>Landes 60</b>
	422 00 000	<b>Poignée Line / chrome</b>
1	550 01 060	<b>Onix new</b>
1	246 00 060	<b>Verona</b>



Robinet

1	412 00 800	<b>Combi chrome</b>
---	------------	---------------------



Blanc mat  
Matte white  
Bianco opaco  
Weiß matt  
Mat wit  
أبيض مت



Chêne naturel  
Natural oak  
Rovere naturale  
Natureiche  
Naturele eiken  
يلوط طبيعي



Pin gris  
Grey pine  
Pino-grigio  
Kiefer grau  
Grijs pijn  
سرو رمادي



Anthracite mat  
Matte Anthracite  
Antracite opaco  
Anthraxil matt  
Mat antracit  
مات أنثراسيت





Résistant à l'eau.  
Resistant to water.

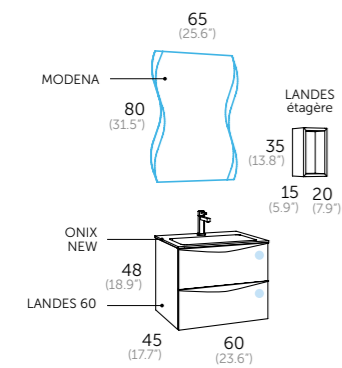

#### Composition | anthracite mat

1	112 45 060	<b>Landes 60</b>
	420 00 000	<b>Poignée Bend / chrome</b>
1	550 01 060	<b>Onix new</b>
1	264 00 080	<b>Módena</b>

#### Auxiliaire

1	112 45 510	<b>Étagère vertical</b>
---	------------	-------------------------

#### Robinet

1	412 00 800	<b>Combi chrome</b>
---	------------	---------------------

Glissières métalliques. Metal interior drawers. Sistema di estrazione metallico. Metallizerleiste. Metalen zijkanten. درج معدني

Extraction e. extraction. Estrazione e. Komplet herausziehbar. Volledig uittrekbaar. لم اناك جرد حتف ما اطن

Fermeture ralentie. Soft close. Frenata soft close. Sanfter Verschluss. Zachtsluitend. نظام إغلاق اتوماتيكي

Organisateur. Organizer unit. Organizzatore. Obere Ablage. Superieure organizer. منظم درج علوي

Glissières Hettich. Hettich sliding system. Guide Hettich. Körperschiene Hettich. Hettich lade system. مفصلات الجانبيهتين

Résistant à l'eau. Resistant to water. Idrorepellente. Wasserfest. Waterafstotend. مقاوم للماء

Système anti buée. Anti fog system. Sistema antiappannamento. Anti Beschlag System. Spiegelverwarming. نظام ضد الضباب

Lumière ambiant. Ambient light. Luce ambiente. Ambient Light. أضواء خلفية

Capteurs de contact. Contact sensor On/Off. Sensore di con tatto On/Off. Sensorschalter On/Off. Aanraken Schakelaar. حساس لمس اثناء / تشغيل

Réversible. It is reversible. Reversibile. Umkehrbar. Omkeerbaar: ja. استيعمال عكسي

## landes.60

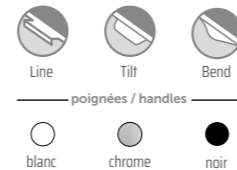



Résistant à l'eau.  
Resistant to water.



# landes.70



option kit industrial

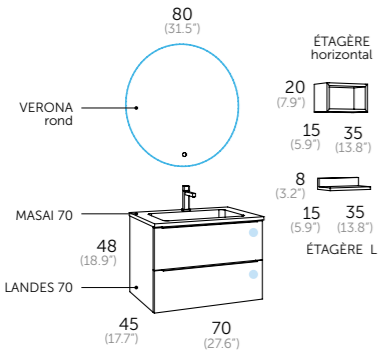

Composition | chêne naturel | anthracite

1	112 24 070	<b>Landes 70</b>
	422 02 000	<b>Poignée Line / noir</b>
1	518 02 070	<b>Masai noir</b>
1	247 00 080	<b>Verona rond</b>

Auxiliaires

1	112 24 505	<b>Étagère horizontale</b>
1	112 45 520	<b>Étagère L</b>



Robinet

1	412 02 800	<b>Combi noir</b>
---	------------	-------------------

- Blanc mat / Matte white / Bianco opaco / Weiß matt / Mat wit / أبيض مت
- Chêne naturel / Natural oak / Rovere naturale / Naturele eiken / بلوط طبيعي
- Pin gris / Grey pine / Pino-grigio / Kiefer grau / Grijs pijn / سرو رمادي
- Anthracite mat / Matte Anthracite / Antracite opaco / Antrazit matt / Mat antracit / مات أنتراسيت

- Glissières métalliques. Metal interior drawers. Sistema di estrazione metallico. Metallzierleiste. Metalen zijkant. درج معدني
- Extraction e. extraction. Estrazione e. Komplet herausziehbar. Volledig uittrekbaar. لم اءك ءرد ءءء م اءن
- Fermeture ralentie. Soft close. Frenata soft dose. Sanfter Verschluss. Zachtsluitend. نظام إءلاق انوماءي
- Organisateur. Organizer unit. Organizzatore. Obere Ablage. Superieure organizer. منظم درء عءو
- Glissières Hettich. Hettich sliding system. Guide Hettich. Körperschiene Hettich. Hettich lade system. مفءالات الماءةءءءء
- Mélamine structuré. Textured melamine. Melamina testurizzata. Textur mit Relief. Reliefstructuur. ملمس منقوش
- Résistant à l'eau. Resistant to water. Idrorepellente. Wasserfest. مقاوم للماء
- Système anti buée. Anti fog system. Sistema antiappannamento. Anti Beschlag System. Spiegelverwarming. نظام ءء الضباب
- Lumière ambient. Ambient light. Luce ambiente. Ambient Light. Omgevingslicht. اءءاءء ءءءءء
- Capteurs de contact. Contact sensor On/Off. Sensore di con tatto On/Off. Sensorschalter On/Off. Aanraken Schakelaar. ءءءءء لمس اءءءء / ءءءءءء

- Line
  - Tilt
  - Bend
- poignées / handles
- blanc
  - chrome
  - noir





Résistant à l'eau.  
Resistant to water.

# landes.70

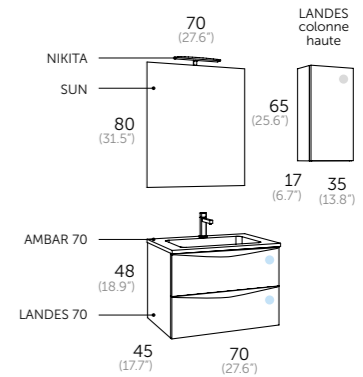

Composition | blanc mat

1	112 35 070	<b>Landes 70</b>
	420 00 000	<b>Poignée Bend / chrome</b>
1	506 01 070	<b>Ambar</b>
1	204 00 070	<b>Sun</b>
1	400 01 171	<b>Nikita</b>

Auxiliaire

1	112 35 435	<b>Colonne haute</b>
---	------------	----------------------

Robinet

1	412 00 800	<b>Combi chrome</b>
---	------------	---------------------

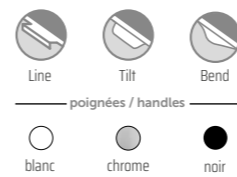

- Glissières métalliques. Metal interior drawers. Sistema di estrazione metallico. Metallzierleiste. Metalen zijkanten. درج معدني
- Extraction e. extraction. Estrazione e. Komplet herausziehbar. Volledig uittrekbaar. لمك جرد حتف ماظن
- Fermeture ralentie. Soft close. Frenata soft close. Sanfter Verschluss. Zachtsluitend. نظام إلتاق اومائتي
- Organisateur. Organizer unit. Organizzatore. Obere Ablage. Superieure organizer. منظم درج علوي
- Glissières Hettich. Hettich sliding system. Guide Hettich. Korpussschiene Hettich. Hettich lade system. مفصلات المائتيهتيش
- Overture par poussée. Push to open. Sistema Push. Öffnung auf Druck. Push to open. باب دفع
- Résistant à l'eau. Resistant to water. Idrorepellente. Wasserfest. مقاوم للماء



## landes.80



Résistant à l'eau.  
Resistant to water.



Résistant à l'eau.  
Resistant to water.

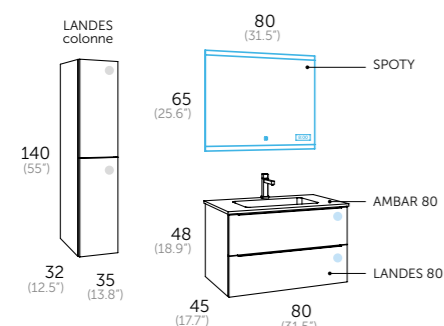

## Composition | chêne naturel

1	112 24 080	Landes 80
	422 00 000	Poignée Line / chrome
1	506 01 080	Ambar
1	267 00 080	Spoty

## Auxiliaires

1	112 24 337	Colonne gauche
---	------------	----------------

## Robinet

1	412 00 800	Combi chrome
---	------------	--------------



Glissières métalliques. Metal interior drawers. Sistema di estrazione metallico. Metallzierleiste. Metalen zijkanten. درج معدني



Extraction e. extraction. Estrazione e. Komplet herausziehbar. Volledig uittrekbaar. لم ااك جرد حرك ف ماظن



Fermeture ralentie. Soft close. Frenata soft close. Sanfter Verschluss. Zachtsluitend. نظام إغلاق ائوماتيكي



Organisateur. Organizer unit. Organizzatore. Obere Ablage. Superieure organizer. منظم درج علوي



Glissières Hettich. Hettich sliding system. Guide Hettich. Korpuschiene Hettich. Hettich lade system. مفصلات المانية هيتش



Fermeture ralentie. Soft close. Frenata soft close. Sanfter Verschluss. Zachtsluitend. نظام إغلاق ائوماتيكي



Mélamine structuré. Textured melamine. Melamina testrunzata. Textur mit Relief. Reliefstruktur. ملمس منقوش



Résistant à l'eau. Resistant to water. Idrorepellente. Wasserfest. مقاوم للماء.



Système anti bueé. Anti fog system. Sistema antiappannamento. Anti Beschlag System. Spiegelverwarming. نظام ضد الضباب



Lumière ambient. Ambient light. Luce ambiente. Ambient Light. اضاءة خلفية



Montre digitale. Digital clock. Orologio digitale. Digitaluhr. Digitale klok. ساعة رقمية



Capturs de contact. Contact sensor On/Off. Sensore di con tatto On/Off. Sensorschalter On/Off. Aanraken Schakelaar. حساس لمس اطفاء / تشغيل



Lecteur de musique intégré, connection Bluetooth. 2 Haut-parleurs 3W chacun. Built in music player, bluetooth connection. 2 speakers of 3W each. Lettore musicale integrato, connessione a Bluetooth. 2 altoparlanti 3W ciascuno. Musik Player integriert, Bluetooth Anschluss. 2 Lautsprecher je mit 3W. Muziekspeler. 2 speakers 3W elke.

مسجلة داخلية بولوتون 2 مكبر صوت 3 واط كل واحد



Line



Tilt



Bend

poignées / handles



blanc



chrome



noir



Blanc mat

Matte white

Bianco opaco

Mat wit

أبيض مت



Chêne naturel

Natural oak

Rovere naturale

Naturele eiken

بلوط طبيعي



Pin gris

Grey pine

Pino-grigio

Kiefer grau

Grijs pijn

سرو رومادي



Anthracite mat

Matte Anthracite

Antracite opaco

Antracit matt

مات أنتراسيت



Glissières métalliques. Metal interior drawers. Sistema di estrazione metallico. Metallzierleiste. Metalen zijkanten. درج معدني



Extraction e. extraction. Estrazione e. Komplet herausziehbar. Volledig uittrekbaar. لم ااك جرد حرك ف ماظن



Fermeture ralentie. Soft close. Frenata soft close. Sanfter Verschluss. Zachtsluitend. نظام إغلاق ائوماتيكي



Organisateur. Organizer unit. Organizzatore. Obere Ablage. Superieure organizer. منظم درج علوي



Glissières Hettich. Hettich sliding system. Guide Hettich. Korpuschiene Hettich. Hettich lade system. مفصلات المانية هيتش



Résistant à l'eau. Resistant to water. Idrorepellente. Wasserfest. Waterafstotend. مقاوم للماء.



Système anti bueé. Anti fog system. Sistema antiappannamento. Anti Beschlag System. Spiegelverwarming. نظام ضد الضباب



Réversible. It is reversible. Reversibile. Umkehrbar. Omkeerbaar. ja استعمال عكسي



Capturs de infrarouge. Infrared sensor On/Off. Sensore infrarosso On/Off. Infrarot Sensorschalter On/Off. Infrarood sensor. حساس بولوتون اطفاء / تشغيل

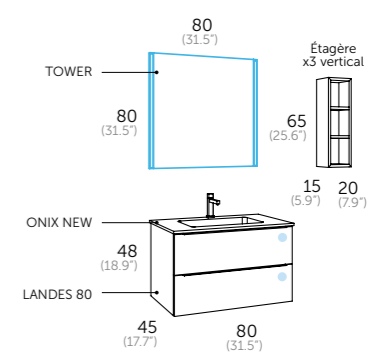

## Composition | blanc mat

1	112 35 080	Landes 80
	421 00 000	Poignée Tilt / chrome
1	550 01 080	Onix new
1	262 00 080	Tower

## Auxiliaires

1	112 35 500	Étagère x3 vertical
---	------------	---------------------

## Robinet

1	412 00 800	Combi chrome
---	------------	--------------



Résistant à l'eau.  
Resistant to water.



# landes.100

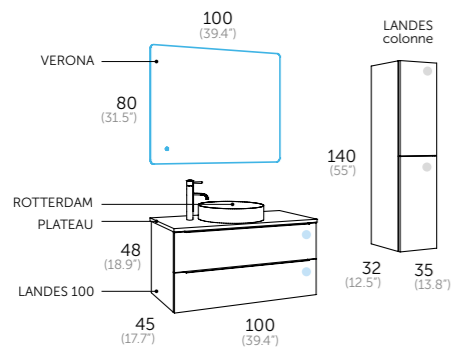

### Composition | anthracite

1	112 45 100	<b>Landes 100</b>
	422 00 000	<b>Poignée Line / chrome</b>
1	112 45 210	<b>Plateau</b>
1	507 01 004	<b>Rotterdam</b>
1	246 00 100	<b>Verona</b>

### Auxiliaires

1	112 45 336	<b>Colonne droite</b>
---	------------	-----------------------

- Blanc mat  
Matte white  
Bianco opaco  
Weiß matt  
Mat wit  
أبيض مت
- Chêne naturel  
Natural oak  
Rovere naturale  
Natureiche  
Naturel eiken  
بلوط طبيعي
- Pin gris  
Grey pine  
Pino-grigio  
Kiefer grau  
Grijs pijn  
سرو رمادي
- Anthracite mat  
Matte Anthracite  
Antracite opaco  
Anthraxit matt  
Mat antracit  
مات أنتراسيت

- Glissières métalliques. Metal interior drawers. Sistema di estrazione metallico. Metallzierleiste. Metalen zijkanalen. درج معدني
- Extraction e. extraction. Estrazione e. Komplet herausziehbar. Volledig uittrekbaar. لم اناك جرد حثف ما اظن
- Fermeture ralentie. Soft close. Frenata soft dose. Sanfter Verschluss. Zachtsluitend. نظام إغلاق أومياتيكي
- Organisateur. Organizer unit. Organizzatore. Obere Ablage. Superieure organizer. منظم درج علوي
- Glissières Hettich. Hettich sliding system. Guide Hettich. Korpussschiene Hettich. Hettich lade system. مفصلات الماينة هتيش
- Fermeture ralentie. Soft close. Frenata soft dose. Sanfter Verschluss. Zachtsluitend. نظام إغلاق أومياتيكي
- Résistant à l'eau. Resistant to water. Idrorepellente. Wasserfest. Waterafstotend. مقاوم للماء
- Système anti buée. Anti fog system. Sistema antiappannamento. Anti Beschlag System. نظام ضد الضباب
- Lumière ambient. Ambient light. Luce ambiente. Ambient Light. Omgevingslicht. اضاءة خلفية
- Capteurs de contact. Contact sensor On/Off. Sensore di con tatto On/Off. Sensorschalter On/Off. Aanraken Schakelaar. حساس لمس اطفاء / تشغيل
- Réversible. It is reversible. Reversibile. Umkehrbar. Omkeerbaar: ja. استعمال عكسي

- Line
  - Tilt
  - Bend
- poignées / handles
- blanc
  - chrome
  - noir







Résistant à l'eau. Resistant to water.



# landes.100

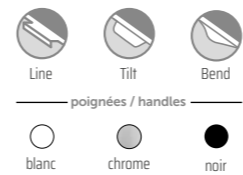

- Glissières métalliques. Metal interior drawers. Sistema di estrazione metallico. Metallzieleiste. Metalen zijkanten. درج معدني
- Extraction e. extraction. Estrazione e. Komplet herausziehbar. Volledig uittrekbaar. لم اك جرد حتف ماظن
- Fermeture ralentie. Soft close. Frenata soft close. Sanfter Verschluss. Zachtsluitend. نظام إلتفاق التوماتيكي
- Organisateur. Organizer unit. Organizzatore. Obere Ablage. Superieure organizer. منظم درج علوي
- Glissières Hettich. Hettich sliding system. Guide Hettich. Korpuschiene Hettich. Hettich lade system. مفصلات الجانبيه هيتش
- Mélamine structuré. Textured melamine. Melamina testurizzata. Textur mit Relief. Relieffstructuur. ملمس منشوش
- Résistant à l'eau. Resistant to water. Idrorepellente. Wasserfest. Waterafstotend. مقاوم للماء
- Système anti buée. Anti fog system. Sistema antiappannamento. Anti Beschlag System. Spiegelverwarming. نظام ضد الضباب
- Capteurs de contact. Contact sensor On/Off. Sensore di con tatto On/Off. Sensorschalter On/Off. Aanraken Schakelaar. حساس لمس إلتفاد / تشغيل
- Miroir loupe 3x éclairé. Magnifying zoom in Mirror. Lente d'ingrandimento 3x. Lupe 3x Vergrößerung. Vergrootglas: verhoging x 3. مكبرمראה 3 أضعاف

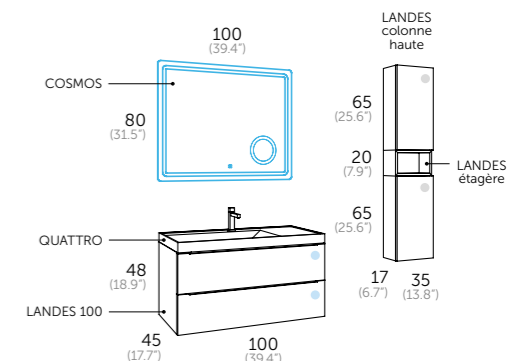

Composition | chêne naturel | blanc mat

1	112 24 100	Landes 100
	422 27 000	Poignée Line / blanc
1	521 01 100	Quattro
1	270 00 100	Cosmos

Auxiliaires

2	112 24 435	Colonne haute
1	112 35 505	Étagère horizontale

Robinet

1	412 24 800	Combi / chêne naturel
---	------------	-----------------------



Résistant à l'eau.  
Resistant to water.



Composition | blanc mat

1	112 35 120	<b>Landes 120</b>
	421 00 000	<b>Poignée Tilt / chrome</b>
1	550 01 122	<b>Onix new</b>
2	241 00 050	<b>Nitro</b>
2	400 00 121	<b>Esther</b>

Auxiliaires

2	112 35 505	<b>Étagère horizontal</b>
---	------------	---------------------------



Robinet

2	412 00 800	<b>Combi chrome</b>
---	------------	---------------------

Glissières métalliques. Metal interior drawers. Sistema di estrazione metallico. Metallzierleiste. Metalen zijkanten. درج معدني

Extraction e. extraction. Estrazione e. Komplet herausziehbar. Volledig uittrekbaar. لمك حرد حرتف ماظن

Fermeture ralentie. Soft close. Frenata soft dose. Sanfter Verschluss. Zachtsluitend. نظام إغلاق انوماتيكي

Organisateur. Organizer unit. Organizzatore. Obere Ablage. Superieure organizer. منظم درج علوي

Glissières Hettich. Hettich sliding system. Guide Hettich. Korpusschiene Hettich. Hettich lade system. مفصلات المانية هيتش

Résistant à l'eau. Resistant to water. Idrorepellente. Wasserfest. Waterafstotend. مقاوم للماء

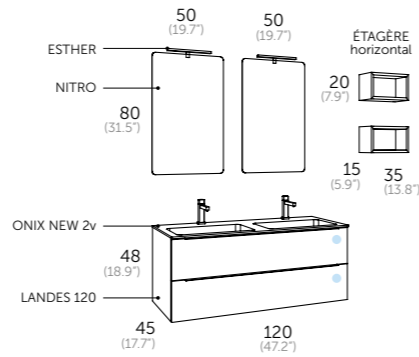

# landes.120



Résistant à l'eau.  
Resistant to water.



Glissières métalliques. Metal interior drawers. Sistema di estrazione metallico. Metallzierleiste. Metalen zijkanten. درج معدني

Extraction e. extraction. Estrazione e. Komplet herausziehbar. Volledig uittrekbaar. لمك حرد حرتف ماظن

Fermeture ralentie. Soft close. Frenata soft dose. Sanfter Verschluss. Zachtsluitend. نظام إغلاق انوماتيكي

Organisateur. Organizer unit. Organizzatore. Obere Ablage. Superieure organizer. منظم درج علوي

Glissières Hettich. Hettich sliding system. Guide Hettich. Korpusschiene Hettich. Hettich lade system. مفصلات المانية هيتش

Mélamine structurée. Textured melamine. Melamina testurizzata. Textur mit Relief. Reliefstructuur. ملمس منشوش

Résistant à l'eau. Resistant to water. Idrorepellente. Wasserfest. Waterafstotend. مقاوم للماء

Système anti buée. Anti fog system. Sistema antiappannamento. Anti Beschlag System. نظام ضد الضباب

Lumière ambient. Ambient light. Luce ambiente. Ambient Light. إضافة خلفية

Capturs de contact. Contact sensor On/Off. Sensore di con tatto On/Off. Sensorschalter On/Off. Aanraken Schakelaar. حساس لمس انفتاح

Réversible. It is reversible. Reversibile. Umkehrbar. Omkeerbaar. ja استعمال عكسي

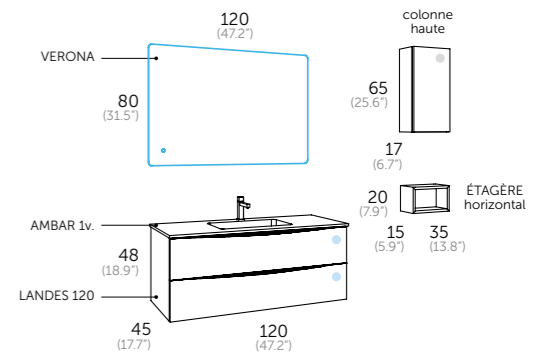

Composition | pin gris

1	112 37 120	<b>Landes 120</b>
	420 00 000	<b>Poignée Bend / chrome</b>
1	506 01 120	<b>Ambar 1v.</b>
1	246 00 120	<b>Verona</b>

Auxiliaires

1	112 37 435	<b>Colonne haute</b>
---	------------	----------------------

1	112 37 505	<b>Étagère horizontal</b>
---	------------	---------------------------



Robinet

1	412 00 800	<b>Combi chrome</b>
---	------------	---------------------











Option ambar plateau avec porte-serviettes intégré

Résistant à l'eau.  
Resistant to water.



-  Glissières métalliques. Metal interior drawers. Sistema di estrazione metallico. Metallzierleiste. Metalen zijkanten. درج معدني
-  Extraction e. extraction. Estrazione e. Komplet herausziehbar. Volledig uittrekbaar. لهماك جرد حتف ماظن
-  Fermeture ralentie. Soft close. Frenata soft close. Sanfter Verschluss. Zachtsluitend. نظام إلتاق ائومانيكي
-  Organisateur. Organizer unit. Organizzatore. Obere Ablage. Superieure organizer. منظم درج علوي
-  Glissières Hettich. Hettich sliding system. Guide Hettich. Korpuschiene Hettich. Hettich lade system. مفصلات امانية هيتش
-  Overture par poussée. Push to open. Sistema Push. Öffnung auf Druck. Push to open. دافع باب
-  Mélamine structuré. Textured melamine. Melamina testurizzata. Textur mit Relief. Relieffstructuur. مفسس متشوش
-  Résistant à l'eau. Resistant to water. Idrorepellente. Wasserfest. Waterafstotend. مقاوم للماء
-  Système anti buée. Anti fog system. Sistema antiappannamento. Anti Beschlag System. نظام ضد الضباب
-  Réversible. It is reversible. Reversibile. Umkehrbar. Omkeerbaar; ja. استبدال عكسي
-  Capteurs de infrarouge. Infrared sensor. On/Off. Sensore infrarosso On/Off. Infrarot Sensorschalter On/Off. Infrarood sensor. حساس بلوتوث اطفاء / تشغيل

-  Line
  -  Tilt
  -  Bend
- poignées / handles
-  blanc
  -  chrome
  -  noir

# landes.120

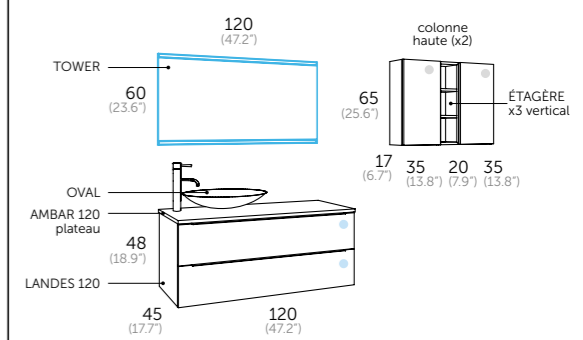

Composition | chêne naturel | blanc mat

1	112 24 120	<b>Landes 120</b>
	422 00 000	<b>Poignée Line / chrome</b>
1	508 01 120	<b>Ambar plateau</b>
1	509 01 001	<b>Oval</b>
1	262 00 120	<b>Tower</b>

Auxiliaires

2	112 24 435	<b>Colonne haute</b>
1	112 35 500	<b>Étagère x3 vertical</b>

-  Blanc mat  
Matte white  
Bianco opaco  
Weiß matt  
Mat wit  
أبيض مت
-  Chêne naturel  
Natural oak  
Rovere naturale  
Natureiche  
Naturel eiken  
يلوط طبيعي
-  Pin gris  
Grey pine  
Pino-grigio  
Kiefer grau  
Grijs pijn  
سرو رمادي
-  Anthracite mat  
Matte Anthracite  
Antracite opaco  
Anthrazit matt  
Mat antracit  
مات أنتراسيت

POIGNÉES

- blanc 420 27 000
- chrome 420 00 000
- noir 420 02 000
- bend
- titl
- line

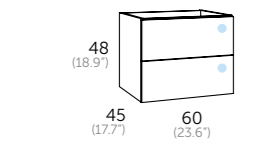

- Finition Référence
- Blanc mat 112 35 060
  - Chêne naturel 112 24 060
  - Pin gris 112 37 060
  - Anthracite mat 112 45 060

plan vasque / washbasin / lavabo / waschtisch / wastafels / تروس

46 61	45.5 60.5	46 61	46 61	46 61	46 61
Référence 550 01 060	Référence 505 01 060	Référence 521 01 060	Référence Blanc 518 01 060 Noir 518 02 060	Référence Blanc 519 01 060 Noir 519 02 060	Référence 508 01 060

Plus de couleurs à la page 284 Plus de couleurs à la page 286

miroirs / mirrors / specchio / spiegel / spiegels / مرايا

60 80	60	60 80	60 80	70	65 80	60 14	60 14
Référence 204 00 060	Référence 244 00 060	Référence 269 00 060	Référence 246 00 060	Référence 247 00 070	Référence 264 00 080	Référence Aluminium 340 11 060	Référence Blanc mat 341 35 060 Chêne naturel 341 24 060

POIGNÉES

- blanc 420 27 000
- chrome 420 00 000
- noir 420 02 000
- bend
- titl
- line

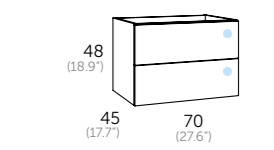

- Finition Référence
- Blanc mat 112 35 070
  - Chêne naturel 112 24 070
  - Pin gris 112 37 070
  - Anthracite mat 112 45 070

plan vasque / washbasin / lavabo / waschtisch / wastafels / تروس

46 71	46 71	46 71	46 71	46 71
Référence 550 01 070	Référence 506 01 070	Référence Blanc 518 01 070 Noir 518 02 070	Référence Blanc 519 01 070 Noir 519 02 070	Référence 508 01 070

Plus de couleurs à la page 284 Plus de couleurs à la page 286

miroirs / mirrors / specchio / spiegel / spiegels / مرايا

70 80	70	70 80	70 80	70	68 14
Référence 204 00 070	Référence 244 00 070	Référence 269 00 070	Référence 246 00 070	Référence 247 00 070	Référence Aluminium 340 11 070

POIGNÉES

- blanc 420 27 000
- chrome 420 00 000
- noir 420 02 000
- bend
- titl
- line

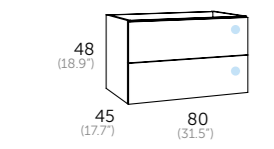

- Finition Référence
- Blanc mat 112 35 080
  - Chêne naturel 112 24 080
  - Pin gris 112 37 080
  - Anthracite mat 112 45 080

plan vasque / washbasin / lavabo / waschtisch / wastafels / تروس

46 81	45.5 80.5	46 81	46 81	46 81	46 81
Référence 550 01 080	Référence 505 01 080	Référence 521 01 080	Référence 506 01 080	Référence Blanc 518 01 080 Noir 518 02 080	Référence Blanc 519 01 080 Noir 519 02 080

Plus de couleurs à la page 284 Plus de couleurs à la page 286

miroirs / mirrors / specchio / spiegel / spiegels / مرايا

80 80	80 65	80 100	80	80	80	80 65	80 14
Référence 204 00 080	Référence 290 00 080	Référence 246 00 100	Référence 247 00 080	Référence 262 00 080	Référence 270 00 080	Référence 267 00 080	Référence Blanc mat 341 35 080 Chêne naturel 341 24 080

POIGNÉES

- blanc 420 27 000
- chrome 420 00 000
- noir 420 02 000
- bend
- titl
- line

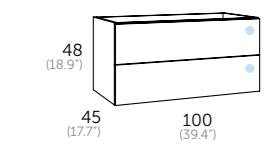

- Finition Référence
- Blanc mat 112 35 100
  - Chêne naturel 112 24 100
  - Pin gris 112 37 100
  - Anthracite mat 112 45 100

plan vasque / washbasin / lavabo / waschtisch / wastafels / تروس

46 101	45.5 100.5	46 101	46 101	46 101	46 101
Référence 550 01 100	Référence 505 01 100	Référence 521 01 100	Référence 506 01 100	Référence Blanc 518 01 100 Noir 518 02 100	Référence Blanc 519 01 100 Noir 519 02 100

Plus de couleurs à la page 284 Plus de couleurs à la page 286

miroirs / mirrors / specchio / spiegel / spiegels / مرايا

100 80	100 65	100 80	100	100 80	100 60	100 65	100 80 14
Référence 204 00 100	Référence 290 00 100	Référence 246 00 100	Référence 247 00 100	Référence 270 00 100	Référence 262 00 100	Référence 267 00 100	Référence Blanc mat 341 35 100 Chêne naturel 341 24 100

POIGNÉES

- blanc 420 27 000
- chrome 420 00 000
- noir 420 02 000
- bend
- titl
- line

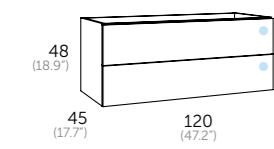

- Finition Référence
- Blanc mat8 112 35 120
  - Chêne naturel 112 24 120
  - Pin gris 112 37 120
  - Anthracite mat 112 45 120

plan vasque / washbasin / lavabo / waschtisch / wastafels / تروس

46 121	46 121	45.5 120.5	46 121	46 121	46 121
Référence 550 01 120	Référence 550 01 122	Référence 505 01 122	Référence Gauche 506 01 121 Droite 506 01 123	Référence 506 01 122	Référence Blanc 518 01 122 Noir 518 02 122

Plus de couleurs à la page 284

miroirs / mirrors / specchio / spiegel / spiegels / مرايا

120 80	120 80	120 65	120 80 14
Référence 204 00 120	Référence 246 00 120	Référence 267 00 120	Référence Blanc mat 341 35 120 Chêne naturel 341 24 120

avec barre de renfort en aluminium

	Blanc mat	Chêne naturel	Pin Gris	Anthracite mat
60	112 35 206	112 24 206	112 37 206	112 45 206
70	112 35 207	112 24 207	112 37 207	112 45 207
80	112 35 208	112 24 208	112 37 208	112 45 208
100	112 35 210	112 24 210	112 37 210	112 45 210
120	112 35 212	112 24 212	112 37 212	112 45 212

vasque à poser / over countertop basins

43Ø 10.5	50 10.5 38	57 11 41	51 11 33
Référence 507 01 004	Référence 507 01 005	Référence 509 01 001	Référence Noir 518 02 051 Plus de couleurs à la page 289

pieds / legs

83 40	
Pour meuble 48 cm hauteur	Chrome 412 00 800 Plus de couleurs à la page 291

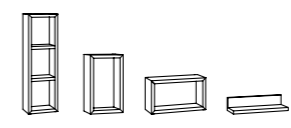

Consulta todos los auxiliares en la página 85.

auxiliares / auxiliary units

landes.colonne

- Blanc mat 112 35 336 112 35 337
- Chêne naturel 112 24 336 112 24 337
- Pin gris 112 37 336 112 37 337
- Anthracite mat 112 45 336 112 45 337

Porte supérieure | Overture par poussée: Top door | Push to open.

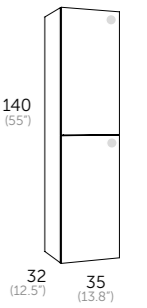

landes.colonne haute

- Blanc mat 112 35 435
- Chêne naturel 112 24 435
- Pin gris 112 37 435
- Anthracite mat 112 45 435

Ouverture réversible | Reversible opening

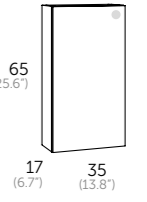



# landes.

MODULAR

Bienvenue dans un univers où tout est possible.

Welcome to an universe where everything is possible.

Benvenuti in un universo in cui tutto è possibile.

Willkommen in einem Universum, in dem alles möglich ist.

Velkommen til et univers, hvor alt er muligt.

مرحبا بكم في الكون حيث كل شيء ممكن



# landes.

MODULAR

### Module étagère ouverte

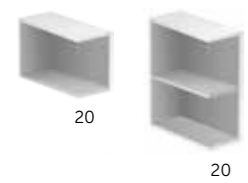

### Module étagères

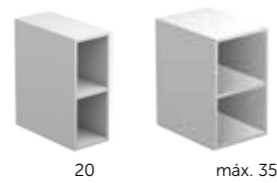

### Module porte

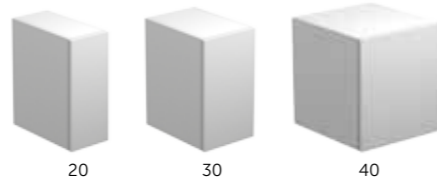

### Module double tiroir

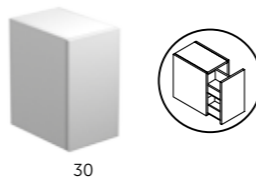

### Poignées



### Bend



### Tilt



### Line



### Auxiliaires



étagère horizontal



20x35x15

étagère vertical



35x20x15

étagère x3 vertical



65x20x15

étagère L horizontal



35x8x15



colonne haute



65x35x17

colonne



140x35x32

### Plateau landes



### Plateau masai

20 couleurs



### flow



### Plan vasque et plateau ambar



### Module 2 tiroirs

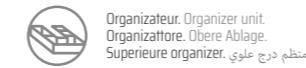

Organisateur, Organizer unit, Organizzatore, Obere Ablage, Superieure organizer, منظم درج علوي

Profondeur 45  
Hauteur 48

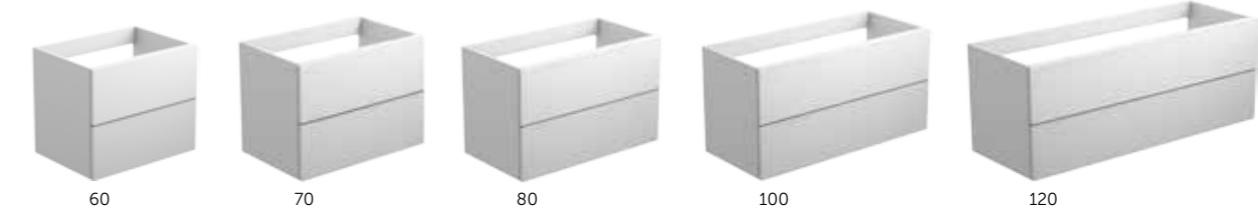

### Module 1 tiroir



Profondeur 45  
Hauteur 24

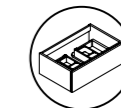
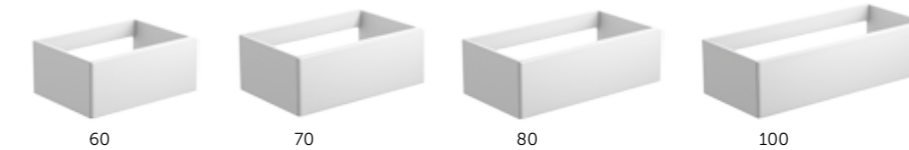

Tiroir avec organisateur.  
Drawer with organizer.

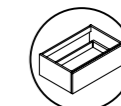
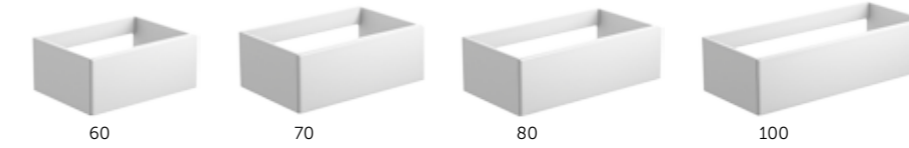

tiroir sans organisateur.  
Drawer without organizer.

### Module creux



Profondeur 45  
Hauteur 24

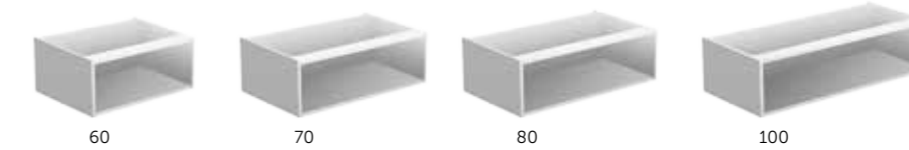



Résistant à l'eau.  
Resistant to water.



# landes.60

MODULAR

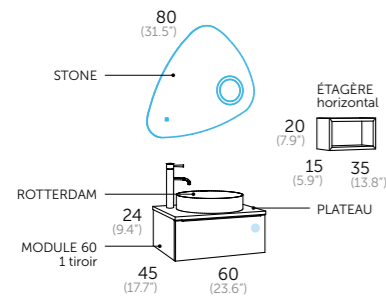

Composition | pin gris | anthracite mat

1	112 37 063	<b>Module 1 tiroir 60 avec organisateur</b>
	421 00 000	<b>Poignée Tilt / chrome</b>
1	112 37 206	<b>Plateau 60</b>
1	507 01 004	<b>Rotterdam</b>
1	261 00 080	<b>Stone</b>

Auxiliaires

1	112 45 505	<b>Étagère horizontale</b>
---	------------	----------------------------

Glissières métalliques. Metal interior drawers. Sistema di estrazione metallico. Metallzierleiste. Metalen zijkant. درج معدني

Extraction e. extraction. Estrazione e. Komplet herausziehbar. Volledig uittrekbaar. لهماك جرد حاتف م اظن

Fermeture ralentie. Soft close. Frenata soft dose. Sanfter Verschluss. Zachtsluitend. نظام إغلاق اوتوماتيكي

Organisateur. Organizer unit. Organizzatore. Obere Ablage. Superieure organizer. منظم درج علوي

Glissières Hettich. Hettich sliding system. Guide Hettich. Korpuschiene Hettich. Hettich lade system. مفصلات الماتية هيتش

Melamine structuré. Textured melamine. Melamina testurizzata. Textur mit Relief. Reliefstructuur. ملمس منقوش

Résistant à l'eau. Resistant to water. Idrorepellente. Wasserfest. مقاوم للماء.

Système anti buée. Anti fog system. Sistema antiappannamento. Anti Beschlag System. نظام ضد الضباب

Mirroir loupe 3x éclairé. Magnifying zoom in Mirror. Lente d'ingrandimento 3x. Lupe 3x Vergrößerung. Vergrootglas: verhoging x 3. مكبر مرآة 3 أضعاف

Capteurs de contact. Contact sensor On/Off. Sensore di con tatto On/Off. Sensorschalter On/Off. Aanraken Schakelaar. حساس لمس اطفاء / تشغيل

Blanc mat  
Matte white  
Bianco opaco  
Weiß matt  
Mat wit  
أبيض مت

Chêne naturel  
Natural oak  
Rovere naturale  
Naturliche  
Naturele eiken  
بلوط طبيعي

Pin gris  
Grey pine  
Pino-grigio  
Kiefer grau  
Grijs pijn  
سرو رمادي

Anthracite mat  
Matte Anthracite  
Antracite opaco  
Antrazit matt  
Mat antracit  
مات أنتراسيت

Dark forest mat  
غابة مظلمة

Mint mat  
نعناع

Line  
blanc

Tilt  
chrome

Bend  
noir

poignées / handles



Résistant à l'eau.  
Resistant to water.



# landes.70

MODULAR

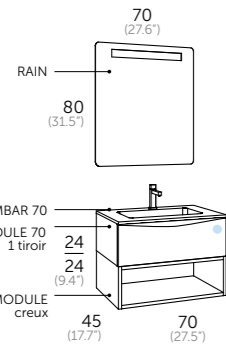

Composition | chêne naturel

1	112 24 073	<b>Module 1 tiroir 70 avec organisateur</b>
	420 00 000	<b>Poignée Bend / chrome</b>
1	112 24 075	<b>Module creux 70</b>
1	506 01 070	<b>Ambar</b>
1	269 00 070	<b>Rain</b>



Robinet

1	412 24 800	<b>Combi / chêne naturel</b>
---	------------	------------------------------

0.13

- Blanc mat  
Matte white  
Bianco opaco  
Weiß matt  
Mat wit  
أبيض مت
- Chêne naturel  
Natural oak  
Rovere naturale  
Natureiche  
Naturel eiken  
بلوط طبيعي
- Pin gris  
Grey pine  
Pino-grigio  
Kiefer grau  
Grijs pijn  
سرو رمادي
- Anthracite mat  
Matte Anthracite  
Antracite opaco  
Anthraxit matt  
Mat antracit  
مات أنتراسيت

- Glissières métalliques. Metal interior drawers. Sistema di estrazione metallico. Metallzierleiste. Metalen zijkanten. درج معدني
- Extraction e. extraction. Estrazione e. Komplet herausziehbar. Volledig uittrekbaar. لهماك جرد حتف ماظن
- Fermature rallentie. Soft close. Frenata soft dose. Sanfter Verschluss. Zachtsluitend. نظام إغلاق أوتوماتيكي
- Organisateur. Organizer unit. Organizzatore. Obere Ablage. Superieure organizer. منظم درج علوي
- Glissières Hettich. Hettich sliding system. Guide Hettich. Körperschiene Hettich. Hettich lade system. مفصلات الماينة هيتيش
- Mélamine structuré. Textured melamine. Melamina testurizzata. Textur mit Relief. Reliefstruktur. ملمس منقوش
- Résistant à l'eau. Resistant to water. Idrorepellente. Wasserfest. Waterafstotend. مقاوم للماء

- Line
  - Tilt
  - Bend
- poignées / handles
- blanc
  - chrome
  - noir







Résistant à l'eau.  
Resistant to water.

# landes.80

MODULAR

-  Glissières métalliques. Metal interior drawers. Sistema di estrazione metallico. Metallzierleiste. Metalen zijkanten. درج معدني
  -  Extraction e. extraktion. Estrazione e. Komplette herausziehbar. Volledig uittrekbaar. لهماك جرد حاتف ماظن
  -  Fermeture ralentie. Soft close. Frenata soft close. Sanfter Verschluss. Zachtsluitend. نظام إغلاق انوماتيكي
  -  Organisateur. Organizer unit. Organizzatore. Obere Ablage. Superieure organizer. منظم درج علوي
  -  Glissières Hettich. Hettich sliding system. Guide Hettich. Korpuschiene Hettich. Hettich lade system. مفصلات الهائية هيتش
  -  Fermeture ralentie. Soft close. Frenata soft close. Sanfter Verschluss. Zachtsluitend. نظام إغلاق انوماتيكي
  -  Mélangine structuré. Textured melamine. Melamina testurizzata. Textur mit Relief. Reliefstructuur. ملمس منقوش
  -  Résistant à l'eau. Resistant to water. Idrorepellente. Wasserfest. Waterafstotend. مقاوم للماء
  -  Line
  -  Tilt
  -  Bend
- poignées / handles
-  blanc
  -  chrome
  -  noir

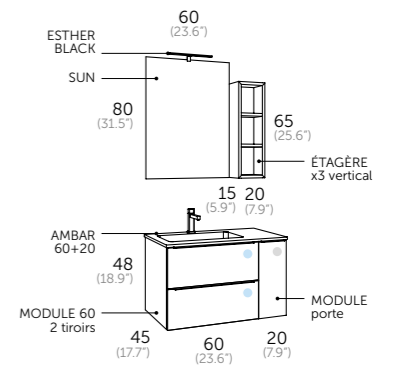

Composition | blanc mat | chêne naturel

1	112 35 060	Module 2 tiroirs 60
1	112 24 020	Module porte 20
	421 02 000	Poignée Tilt / noir
1	112 24 500	Étagère x3 vertical
1	506 01 081	Ambar (60+20) gauche
1	204 00 060	Sun
1	400 02 121	Esther black 30

Robinet

1	412 02 800	Combi / noir
---	------------	--------------

-  Blanc mat  
Matte white  
Bianco opaco  
Weiß matt  
Mat wit  
أبيض مت
-  Chêne naturel  
Natural oak  
Rovere naturale  
Naturliche  
Naturele eiken  
بلوط طبيعي
-  Pin gris  
Grey pine  
Pino-grigio  
Kiefer grau  
Grijs pijn  
سرو رمادي
-  Anthracite mat  
Matte Anthracite  
Antracite opaco  
Antrazit matt  
Mat antracit  
مات أنتراسيت
-  Dark forest mat  
غاية مظلمة
-  Mint mat  
نعناع



- Line
  - Tilt
  - Bend
- poignées / handles
- blanc
  - chrome
  - noir

- Blanc mat  
Matte white  
Bianco opaco  
Weiß matt  
Mat wit  
أبيض مت
- Chêne naturel  
Natural oak  
Rovere naturale  
Naturliche  
Naturel eiken  
بلوط طبيعي
- Pin gris  
Grey pine  
Pino-grigio  
Kiefer grau  
Grijs pijn  
سرو رمادي
- Anthracite mat  
Matte Anthracite  
Antracite opaco  
Antrazit matt  
Mat antracit  
مات أنتراسيت
- Dark forest mat  
غابة مظلمة
- Mint mat  
نعناع



Une composition, plusieurs sensations.  
blanc mat | mint mat | dark forest mat



- Glissières métalliques. Metal interior drawers. Sistema di estrazione metallico. Metallzierleiste. Metalen zijkanten. درج معدني
- Extraction e. extraction. Estrazione e. Komplett herausziehbar. Volledig uittrekbaar. لمك جرد جتف ماظن
- Fermature ralentie. Soft close. Frenata soft close. Sanfter Verschluss. Zachtsluitend. نظام إغلاق اتوماتيكي
- Organizateur. Organizer unit. Organizatore. Obere Ablage. Superiore organizer. منظم درج علوي
- Glissières Hettich. Hettich sliding system. Guide Hettich. Korpuschiene Hettich. Hettich lade system. مفصلات الجانبيه هيتش
- Résistant à l'eau. Resistant to water. Idrorepellente. Wasserfest. Waterafstotend. مقاوم للماء
- Système anti buée. Anti fog system. Sistema antiappannamento. Anti Beschlag System. Spieglverwarming. نظام ضد الضباب
- Capteurs de contact. Contact sensor On/Off. Sensore di con tatto On/Off. Sensorschalter On/Off. Aanraken Schakelaar. حساس لمس اطفاء / تشغيل
- Mirir loupe 3x éclairé. Magnifying zoom in Mirror. Lente d'ingrandimento 3x. Lupe 3x Vergrößerung. Vergrootglas: verhoging x 3. مكبر مرآة 3 أضعاف

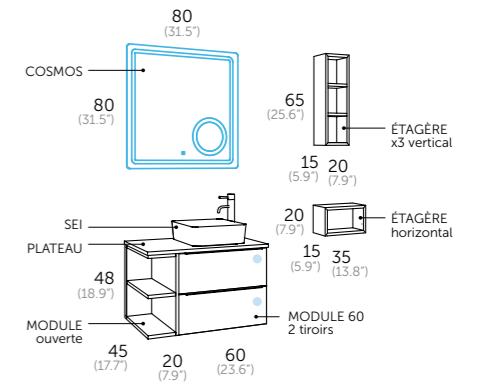

Composition | blanc mat | anthracite mat

1	112 35 060	<b>Module 2 tiroirs 60</b>
	422 00 000	<b>Poignée Line / chrome</b>
1	112 45 025	<b>Module ouverte</b>
1	112 35 208	<b>Plateau 80</b>
1	530 01 006	<b>Sei</b>
1	270 00 080	<b>Cosmos</b>

Auxiliaires

1	112 45 500	<b>Étagère x3 vertical</b>
1	112 45 505	<b>Étagère horizontal</b>



# landes.80

MODULAR





Blanc mat avec module 2 tiroirs et miroir Stone.

Résistant à l'eau.  
Resistant to water.



# landes.90

MODULAR

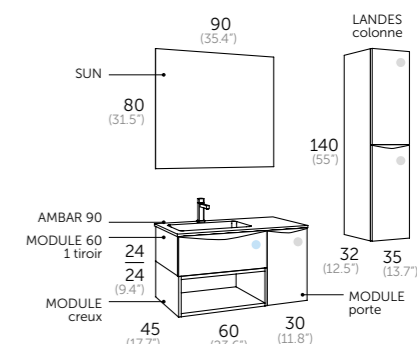

Composition | pin gris

1	112 37 063	<b>Module 1 tiroir 60 avec organisateur</b>
1	112 37 030	<b>Module porte 30</b>
	420 00 000	<b>Poignée Bend / chrome</b>
1	112 37 065	<b>Module creux 60</b>
1	506 01 091	<b>Ambar (60+30) gauche</b>
1	204 00 090	<b>Sun</b>

Auxiliaires

1	112 37 336	<b>Colonne droite</b>
		<b>Robinet</b>
1	412 00 800	<b>Combi chrome</b>



Glissières métalliques. Metal interior drawers. Sistema di estrazione metallico. Metallzierleiste. Metalen zijkant.  
درج معدني



Extraction e. extraction. Estrazione e. Komplet herausziehbar. Volledig uittrekbaar.  
لمك جرد حتف ماظن



Fermeture ralentie. Soft close. Frenata soft close. Sanfter Verschluss. Zachtsluitend.  
نظام إغلاق أوماتيكي



Organisateur. Organizer unit. Organizzatore. Obere Ablage. Superieure organizer.  
منظم درج علوي



Glissières Hettich. Hettich sliding system. Guide Hettich. Korpuschiene Hettich. Hettich lade system.  
مفصلات المانية هيتش



Fermeture ralentie. Soft close. Frenata soft close. Sanfter Verschluss. Zachtsluitend.  
نظام إغلاق أوماتيكي



Mélamine structurée. Textured melamine. Melamina testurizzata. Textur mit Relief. Reliefstructuur.  
ملمس منقوش



Résistant à l'eau. Resistant to water. Idrorepellente. Wasserfest. Waterafstotend.  
مقاوم للماء



Line

Tilt

Bend

poignées / handles



blanc

chrome

noir



Blanc mat  
Matte white  
Bianco opaco  
Weiß matt  
Mat wit  
أبيض مت



Chêne naturel  
Natural oak  
Rovere naturale  
Naturliche  
Naturel eiken  
بلوط طبيعي



Pin gris  
Grey pine  
Pino-grigio  
Kiefer grau  
Grijs pijn  
سرو رمادي



Anthracite mat  
Matte Anthracite  
Antracite opaco  
Anthraxil matt  
Mat antracit  
مات أنتراسيت



Résistant à l'eau.  
Resistant to water.



# landes.100

## MODULAR

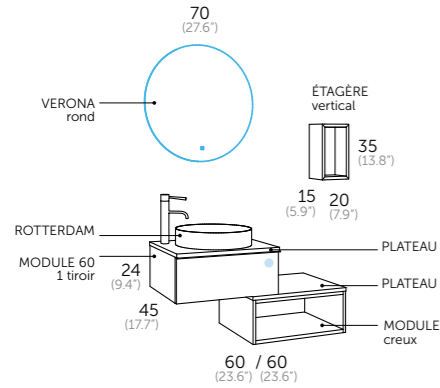

Composition | blanc mat | chêne naturel

1	112 35 063	<b>Module 1 tiroir 60 avec organisateur</b>
	422 27 000	<b>Poignée Line / blanc</b>
2	112 24 206	<b>Plateau 60</b>
1	112 24 065	<b>Module creux 60</b>
1	507 01 004	<b>Rotterdam</b>
1	247 00 070	<b>Verona Rond</b>

Auxiliaires

1	112 24 510	<b>Étagère vertical</b>
---	------------	-------------------------



- Glissières métalliques. Metal interior drawers. Sistema di estrazione metallico. Metallizerleiste. Metalen zijkanten. درج معدني
- Extraction e. extraction. Estrazione e. Komplet herausziehbar. Volledig uittrekbaar. لم ااك جرد حتف ما اظن
- Fermeture ralentie. Soft close. Frenata soft dose. Sanfter Verschluss. Zachtsluitend. نظام إغلاق اوتوماتيكي
- Organisateur. Organizer unit. Organizzatore. Obere Ablage. Superieure organizer. منظم درج علوي
- Glissières Hettich. Hettich sliding system. Guide Hettich. Korpuschiene Hettich. Hettich lade system. مفصلات المانتيهتشي
- Mélamine structuré. Textured melamine. Melamina testurizzata. Textur mit Relief. Reliëfstructuur. ملمس منقوش
- Résistant à l'eau. Resistant to water. Idrorepellente. Wasserfest. مقاوم للماء
- Système anti buée. Anti fog system. Sistema antiappannamento. Anti Beschlag System. نظام ضد الضباب
- Lumière ambient. Ambient light. Luce ambiente. Ambient Light. اضاءة خلفية
- Capteurs de contact. Contact sensor On/Off. Sensore di con tatto On/Off. Sensorschalter On/Off. Aanraken Schakelaar. حساس لمس اطفاء / تشغيل



Blanc mat  
Matte white  
Bianco opaco  
Weiß matt  
Mat wit  
أبيض مت



Chêne naturel  
Natural oak  
Rovere naturale  
Naturliche  
Naturele eiken  
بلوط طبيعي



Pin gris  
Grey pine  
Pino-grigio  
Kiefer grau  
Grijs pijn  
سرو رومادي



Anthracite mat  
Matte Anthracite  
Antracite opaco  
Anthraxit matt  
Mat antracit  
مات أنتراسيت



Dark forest mat  
غابة مظلمة



Mint mat  
نعناع



Line



Tilt



Bend

poignées / handles



blanc



chrome



noir





Résistant à l'eau.  
Resistant to water.



# landes.100

MODULAR

- Glissières métalliques. Metal interior drawers. Sistema di estrazione metallico. Metallzierleiste. Metalen zijkanten. درج معدني
- Extraction e. extraction. Estrazione e. Komplet herausziehbar. Volledig uittrekbaar. لمك جرد جتف ماظن
- Fermeture ralentie. Soft close. Frenata soft close. Sanfter Verschluss. Zachtsluitend. نظام إغلاق أوماتيكي
- Organisateur. Organizer unit. Organizzatore. Obere Ablage. Superieure organizer. منظم درج علوي
- Glissières Hettich. Hettich sliding system. Guide Hettich. Korpuschiene Hettich. Hettich lade system. مفصلات المانية هيتش
- Fermeture ralentie. Soft close. Frenata soft close. Sanfter Verschluss. Zachtsluitend. نظام إغلاق أوماتيكي
- Overture par poussée. Push to open. Sistema Push. Öffnung auf Druck. Push to open. باب دفع
- Mélamine structuré. Textured melamine. Melamina testurizzata. Textur mit Relief. Reliefstructuur. ملمس منشوش
- Résistant à l'eau. Resistant to water. Idrorepellente. Wasserfest. Waterafstotend. مقاوم للماء
- Système anti buée. Anti fog system. Sistema antiappannamento. Anti Beschlag System. نظام ضد الضباب
- Lumière ambient. Ambient light. Luce ambiente. Ambient Light. Omgevingslicht. اضاءة خلفية
- Capteurs de contact. Contact sensor On/Off. Sensore di con tatto On/Off. Sensorschalter On/Off. Aanraken Schakelaar. حساس لمس انقفاء / تشغيل
- Réversible. It is reversible. Reversibile. Umkehrbar. Omkeerbaar: ja. استعمال عكسي

- Line
  - Tilt
  - Bend
- poignées / handles
- blanc
  - chrome
  - noir

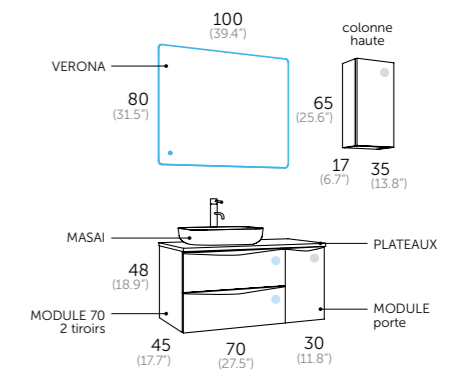

Composition | chêne naturel

1	112 24 070	<b>Module 2 tiroirs 70</b>
1	112 24 030	<b>Module porte 30</b>
	420 02 000	<b>Poignée Bend / noir</b>
1	112 24 210	<b>Plateau 100</b>
1	518 02 051	<b>Masai</b>
1	246 00 100	<b>Verona</b>

Auxiliaires

1	112 24 435	<b>Colonne haute</b>
---	------------	----------------------



- Blanc mat  
Matte white  
Bianco opaco  
Weiß matt  
Mat wit  
أبيض مت
- Chêne naturel  
Natural oak  
Rovere naturale  
Natureiche  
Naturel eiken  
يلوط طبيعي
- Pin gris  
Grey pine  
Pino-grigio  
Kiefer grau  
Grijs pijn  
سرو رمادي
- Anthracite mat  
Matte Anthracite  
Antracite opaco  
Antracit matt  
Mat antracit  
مات أنتراسيت



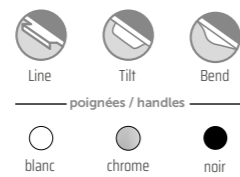

-  Glissières métalliques. Metal interior drawers. Sistema di estrazione metallico. Metallzieleiste. Metalen zijkanten. درج معدني
-  Extraction e. extraction. Estrazione e. Komplet herausziehbar. Volledig uittrekbaar. لمك جرد جت ف ماظن
-  Fermeture ralentie. Soft close. Frenata soft close. Sanfter Verschluss. Zachtsluitend. نظام إغلاق انوماتيكي
-  Organisateur. Organizer unit. Organizzatore. Obere Ablage. Superieure organizer. منظم درج علوي
-  Glissières Hettich. Hettich sliding system. Guide Hettich. Korpuschiene Hettich. Hettich lade system. مفصلات المانوية هيتش
-  Fermeture ralentie. Soft close. Frenata soft close. Sanfter Verschluss. Zachtsluitend. نظام إغلاق انوماتيكي
-  Résistant à l'eau. Resistant to water. Idrorepellente. Wasserfest. Waterafstotend. مقاوم للماء

# landes.110

MODULAR

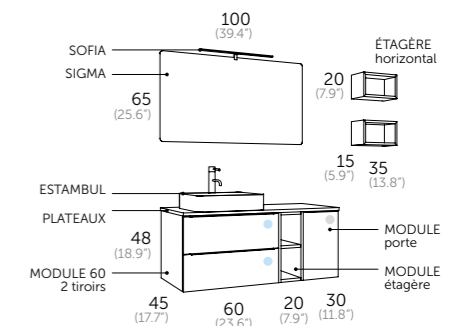

Composition | blanc mat | dark forest mat

1	112 35 060	Module 2 tiroirs 60
1	112 35 030	Module porte 30
	421 00 000	Poignée Tilt / chrome
1	112 29 022	Module étagère 20
1	112 35 211	Plateau 110
1	507 01 005	Estambul
1	290 00 100	Sigma
1	400 00 141	Sofia

Auxiliaires

1	112 35 505	Étagère horizontale B.
1	112 29 505	Étagère horizontale DF.





Résistant à l'eau.  
Resistant to water.



# landes.110

MODULAR

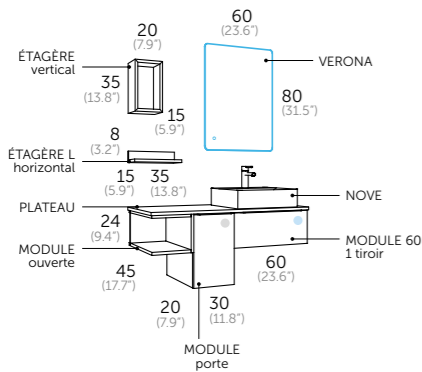

Composition | chêne naturel | mint | dark forest

1	112 24 063	Module 1 tiroir 60 avec organisateur
1	112 24 030	Module porte 30
	422 00 000	Poignée Line / chrome
1	112 29 026	Module ouverte
1	112 24 211	Plateau 110
1	530 01 095	Novè
1	246 00 060	Verona

Auxiliaires

1	112 29 510	Étagère vertical
1	112 28 520	Étagère L

Robinet

1	412 00 800	Combi chrome
---	------------	--------------



Glissières métalliques. Metal interior drawers. Sistema di estrazione metallico. Metallizerleiste. Metalen zijkanalen. درج معدني

Extraction e. extraction. Estrazione e. Komplet herausziehbar. Volledig uittrekbaar. لم اناك جرد حركه ما اطن

Fermeture ralentie. Soft close. Frenata soft close. Sanfter Verschluss. Zachtsluitend. نظام إغلاق اتوماتيكي

Organisateur. Organizer unit. Organizzatore. Obere Ablage. Superiore organizer. منظم درج علوي

Glissières Hettich. Hettich sliding system. Guide Hettich. Körperschiene Hettich. Hettich lade system. مقصات الجانبيه هيتش

Fermeture ralentie. Soft close. Frenata soft close. Sanfter Verschluss. Zachtsluitend. نظام إغلاق اتوماتيكي

Mélamine structuré. Textured melamine. Melamina testurizzata. Textur mit Relief. Reliefstructuur. ملمس منقوش

Résistant à l'eau. Resistant to water. Idrorepellente. Wasserfest. مقاوم للماء

Système anti buée. Anti fog system. Sistema antiappannamento. Anti Beschlag System. نظام ضد الضباب

Lumière ambiante. Ambient light. Luce ambiente. Ambient Light. أضواء خلفية

Capteurs de contact. Contact sensor On/Off. Sensore di con tatto On/Off. Sensorschalter On/Off. Aanraken Schakelaar. حساس لمس انفتاح / تشغيل

Réversible. It is reversible. Reversibile. Umkehrbar. Omkeerbaar: ja استعمال عكسي



Blanc mat  
Matte white  
Bianco opaco  
Weiß matt  
Mat wit  
أبيض مت

Chêne naturel  
Natural oak  
Rovere naturale  
Naturliche  
Naturele eiken  
بلوط طبيعي

Pin gris  
Grey pine  
Pino-grigio  
Kiefer grau  
Grijs pijn  
سرو رمادي

Anthracite mat  
Matte Anthracite  
Antrazit matt  
Mat antracit  
مات أنثرايسيت

Dark forest mat  
غابة مظلمة

Mint mat  
نعناع

Line  
Tilt  
Bend  
poignées / handles  
blanc  
chrome  
noir

Résistant à l'eau.  
Resistant to water.



# landes.115

MODULAR

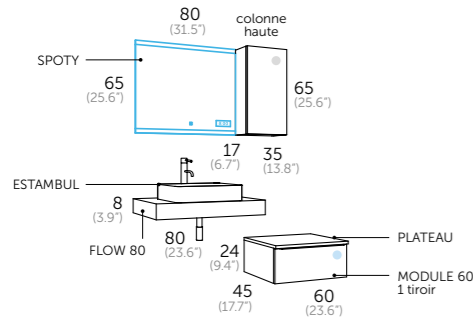

### Composition | pin gris

1	112 37 064	Module 60 - 1 tiroir
	421 27 000	Poignée Tilt / blanc
1	112 37 206	Plateau 60
1	138 37 080	Flow 80
1	112 37 435	Colonne haute
1	507 01 005	Estambul
1	267 00 080	Spoty
1	410 00 101	Siphon chrome



- Blanc mat / Matte white / Bianco opaco / Weiß matt / Mat wit / أبيض مت
- Chêne naturel / Natural oak / Rovere naturale / Natureiche / Naturel eiken / بلوط طبيعي
- Pin gris / Grey pine / Pino-grigio / Kiefer grau / Grijs pijn / سرو رمادي
- Anthracite mat / Matte Anthracite / Antracite opaco / Anthrazit matt / Mat antracit / مات أنتراسيت

- Glissières métalliques. Metal interior drawers. Sistema di estrazione metallico. Metallzierleiste. Metalen zijkanfen. درج معدني
- Extraction e. extraction. Estrazione e. Komplet herausziehbar. Volledig uittrekbaar. لم اناك جرد حرتف ماظن
- Fermeture ralentie. Soft close. Frenata soft close. Sanfter Verschluss. Zachtsluitend. نظام إغلاق التوماتيكي
- Glissières Hettich. Hettich sliding system. Guide Hettich. Körperschiene Hettich. Hettich lade system. مفصلات الجانبة هيتش
- Overture par poussée. Push to open. Sistema Push. Öffnung auf Druck. Push to open. باب دفع
- Mélamine structuré. Textured melamine. Melamina testurizzata. Textur mit Relief. Reliefstructuur. ملمس منقوش
- Résistant à l'eau. Resistant to water. Idrorepellente. Wasserfest. Waterafstotend. مقاوم للماء
- Système anti buée. Anti fog system. Sistema antappannamento. Anti Beschlag System. Spiegelverwarming. نظام ضد الضباب
- Lumière ambiante. Ambient light. Luce ambiente. Ambient Light. Omgevingslicht. أضواء خلفية
- Montre digitale. Digital clock. Orologio digitale. Digitaluhr. Digitale klok. ساعة رقمية
- Captteurs de contact. Contact sensor On/Off. Sensore di con tatto On/Off. Sensorschalter On/Off. Aanraken Schakelaar. حساس لمس اللفاء / تشغيل
- Lecteur de musique intégré, connection Bluetooth. 2 Haut-parleurs 3W chacun. Built in music player, bluetooth connection. 2 speakers of 3W each. Lettore musicale integrato, connessione a Bluetooth. 2 altoparlanti 3W ciascuno. Musik Player integriert, Bluetooth Anschluss. 2 Lautsprecher je mit 3W. Muziekspeler. 2 speakers 3W elke. مسجلة داخلية بلوتوث 2 مكبر صوت 3 واط كل واحد

- Line
- Tilt
- Bend
- poignées / handles
- blanc
- chrome
- noir







- Line
  - Tilt
  - Bend
- poignées / handles
- blanc
  - chrome
  - noir

- Blanc mat  
Matte white  
Bianco opaco  
Weiß matt  
Mat wit
- Chêne naturel  
Natural oak  
Rovere naturale  
Naturele eiken
- Pin gris  
Grey pine  
Pino-grigio  
Kiefer grau  
Grijs pijn
- Anthracite mat  
Matte Anthracite  
Antracite opaco  
Anthraxil matt  
Mat antracit

- Dark forest mat  
غابة مظلمة
- Mint mat  
نعناع

Résistant à l'eau.  
Resistant to water.

# landes.120

MODULAR



- Glissières métalliques. Metal interior drawers. Sistema di estrazione metallico. Metallzieleiste. Metalen zijkant.  
درج معدني
- Extraction e. extraction. Estrazione e. Komplet herausziehbar. Volledig uittrekbaar.  
لماك جرد حتف ماظن
- Fermeture ralentie. Soft close. Frenata soft close. Sanfter Verschluss. Zachtsluitend.  
نظام إغلاق اتوماتيكي
- Organisateur. Organizer unit. Organizzatore. Obere Ablage. Superieure organizer.  
منظم درج علوي
- Glissières Hettich. Hettich sliding system. Guide Hettich. Korpuschiene Hettich. Hettich lade system.  
مفصلات الجانبيه
- Fermeture ralentie. Soft close. Frenata soft close. Sanfter Verschluss. Zachtsluitend.  
نظام إغلاق اتوماتيكي
- Overture par poussée. Push to open. Sistema Push. Öffnung auf Druck. Push to open.  
باب دفع
- Mélamine structurée. Textured melamine. Melamina testurizzata. Textur mit Relief. Reliefstructuur.  
لملمس منقوش
- Résistant à l'eau. Resistant to water. Idrorepellente. Wasserfest. Waterafstotend.  
مقاوم للماء

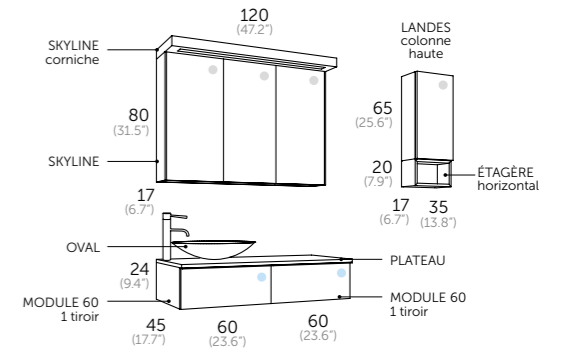

Composition | chêne naturel | anthracite mat

1	112 45 063	Module 1 tiroir 60 avec organisateur
1	112 24 064	Module 1 tiroir 60
	422 02 000	Poignée Line / noir
1	112 24 212	Plateau 120
1	509 01 001	Oval
1	341 24 120	Skyline
1	341 24 121	Corniche

Auxiliaires

1	112 24 435	Colonne haute
1	112 45 505	Étagère horizontal





Résistant à l'eau.  
Resistant to water.

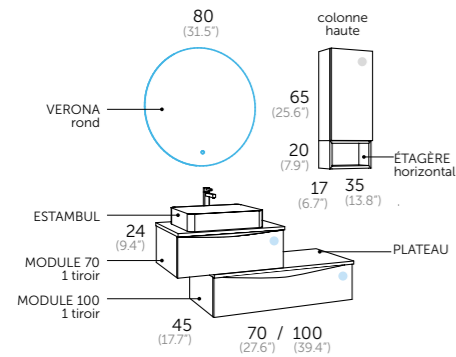

Composition | blanc mat | anthracite mat

1	112 35 073	Module 1 tiroir 70 avec organisateur
	112 35 207	Plateau 70
1	112 45 104	Module 1 tiroir 100
	112 45 210	Plateau 100
	420 27 000	Poignée Bend / blanc
1	112 45 435	Colonne haute
1	112 35 505	Étagère horizontal
1	507 01 005	Estambul
1	247 00 080	Verona rond



- Glissières métalliques. Metal interior drawers. Sistema di estrazione metallico. Metallzierleiste. Metalen zijkanten. درج معدني
- Extraction e. extraction. Estrazione e. Komplet herausziehbar. Volledig uittrekbaar. لم ااك چرد حتف ماظن
- Fermeture ralentie. Soft close. Frenata soft close. Sanfter Verschluss. Zachtsluitend. نظام إغلاق اوماتيكي
- Organisateur. Organizer unit. Organizzatore. Obere Ablage. Superieure organizer. منظم درج علوي
- Glissières Hettich. Hettich sliding system. Guide Hettich. Korpuschiene Hettich. Hettich lade system. مفصلات المانيه هيتش
- Overture par poussée. Push to open. Sistema Push. Öffnung auf Druck. Push to open. داف
- Résistant à l'eau. Resistant to water. Idrorepellente. Wasserfest. Waterafstotend. مقاوم للماء
- Système anti buée. Anti fog system. Sistema antiappannamento. Anti Beschlag System. Spiegelverwarming. نظام ضد الضباب
- Lumière ambient. Ambient light. Luce ambiente. Ambient Light. Omgevingslicht. اضاءة خلفية
- Capteurs de contact. Contact sensor On/Off. Sensore di con tatto On/Off. Sensorschalter On/Off. Aanraken Schakelaar. حساس لمس اطفاء / تشغيل

# landes.120

## MODULAR

- Blanc mat / Matte white / Bianco opaco / Weiß matt / Mat wit / أبيض مت
- Chêne naturel / Natural oak / Rovere naturale / Natureiche / Naturele eiken / بلوط طبيعي
- Pin gris / Grey pine / Pino-grigio / Kiefer grau / Grijs pijn / سرو رمادي
- Anthracite mat / Matte Anthracite / Antracite opaco / Anthrazit matt / Mat antracit / مات أنتراسيت
- Dark forest mat / غابة مظلمة
- Mint mat / نعناع

- Système anti buée. Anti fog system. Sistema antiappannamento. Anti Beschlag System. Spiegelverwarming. نظام ضد الضباب
- Réversible. It is reversible. Reversibile. Umkehrbar. Omkeerbaar: ja / استعمال عكسي
- Capteurs de infrarouge. Infrared sensor On/Off. Sensore infrarosso On/Off. Infrarood sensor. حساس بلوتوث اطفاء / تشغيل

- Line / poignées / handles
- Tilt
- Bend
- blanc
- chrome
- noir

- Glissières métalliques. Metal interior drawers. Sistema di estrazione metallico. Metallzierleiste. Metalen zijkanten. درج معدني
- Extraction e. extraction. Estrazione e. Komplet herausziehbar. Volledig uittrekbaar. لم ااك چرد حتف ماظن
- Fermeture ralentie. Soft close. Frenata soft close. Sanfter Verschluss. Zachtsluitend. نظام إغلاق اوماتيكي
- Organisateur. Organizer unit. Organizzatore. Obere Ablage. Superieure organizer. منظم درج علوي
- Glissières Hettich. Hettich sliding system. Guide Hettich. Korpuschiene Hettich. Hettich lade system. مفصلات المانيه هيتش
- Fermeture ralentie. Soft close. Frenata soft close. Sanfter Verschluss. Zachtsluitend. نظام إغلاق اوماتيكي
- Mélangine structurée. Textured melamine. Melamina testurizzata. Textur mit Relief. Relieffstructuur. ملمس منقوش
- Résistant à l'eau. Resistant to water. Idrorepellente. Wasserfest. Waterafstotend. مقاوم للماء

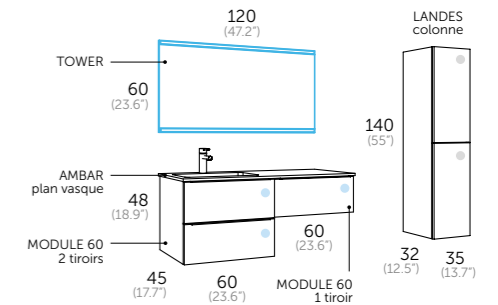

Composition | pin gris | blanc mat

1	112 37 060	Module 2 tiroirs 60
1	112 35 064	Module 1 tiroir 60
	421 27 000	Poignée Tilt / blanc
1	506 01 121	Ambar 1v. gauche
1	262 00 120	Tower 120

Auxiliaires

1	112 37 336	Colonne droite
---	------------	----------------

Robinet

1	412 00 800	Combi chrome
---	------------	--------------



Résistant à l'eau.  
Resistant to water.





Résistant à l'eau.  
Resistant to water.



# landes.120

MODULAR

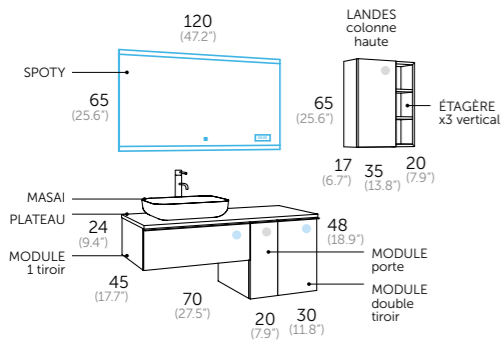

### Composition | chêne naturel | anthracite mat

1	112 24 073	<b>Module 1 tiroir 70 avec organisateur</b>
1	112 45 020	<b>Module porte 20</b>
1	112 24 034	<b>Module double tiroir</b>
	422 02 000	<b>Poignée Line / noir</b>
1	112 24 212	<b>Plateau 120</b>
1	518 02 051	<b>Masai</b>
1	267 00 120	<b>Spoty</b>

### Auxiliaires

1	112 24 435	<b>Colonne haute</b>
1	112 45 500	<b>Étagère x3 vertical</b>



Glissières métalliques. Metal interior drawers. Sistema di estrazione metallico. Metallzierleiste. Metalen zijkanten. درج معدني

Extraction e. extraction. Estrazione e. Komplette herausziehbar. Volledig uittrekbaar. لهماك جرد جرتف م اظن

Fermeture ralentie. Soft close. Frenata soft close. Sanfter Verschluss. Zachtsluitend. نظام إغلاق انوماتيكي

Organisateur. Organizer unit. Organizzatore. Obere Ablage. Superieure organizer. منظم درج علوي

Glissières Hettich. Hettich sliding system. Guide Hettich. Korpuschiene Hettich. Hettich lade system. مفصلات اللماية هيتش

Fermeture ralentie. Soft close. Frenata soft close. Sanfter Verschluss. Zachtsluitend. نظام إغلاق انوماتيكي

Overture par poussée. Push to open. Sistema Push. Öffnung auf Druck. Push to open. باب دفع

Mélamine structuré. Textured melamine. Melamina testurizzata. Textur mit Relief. Reliefstruktur. ملمس منقوش

Résistant à l'eau. Resistant to water. Idrorepellente. Wasserfest. مقاوم للماء

Système anti buée. Anti fog system. Sistema antiappannamento. Anti Beschlag System. نظام ضد الضباب

Lumière ambient. Ambient light. Luce ambiente. Ambient Light. أضواء خلفية

Montre digitale. Digital clock. Orologio digitale. Digitaluhr. Digitaal klok. ساعة رقمية

Capteurs de contact. Contact sensor On/Off. Sensore di con tatto On/Off. Sensorschalter On/Off. Aanraken Schakelaar. حساس لمس اطفاء / تشغيل

Lecteur de musique intégré. connection Bluetooth. 2 Haut-parleurs 3W chacun. Built in music player, bluetooth connection. 2 speakers of 3W each. Lettore musicale integrato, connessione a Bluetooth. 2 altoparlanti 3W ciascuno. Musik Player integriert, Bluetooth Anschluss. 2 Lautsprecher je mit 3W. Muziekspeler. 2 speakers 3W elke.

مسجلة داخلية. بلوتوث 2 مكبر صوت 3 وات كل واحد

Blanc mat  
Matte white  
Bianco opaco  
Weiß matt  
Mat wit  
أبيض مت

Chêne naturel  
Natural oak  
Rovere naturale  
Naturliche  
Naturele eiken  
بلوط طبيعي

Pin gris  
Grey pine  
Pino-grigio  
Kiefer grau  
Grijs pijn  
سرو رمادي

Anthracite mat  
Matte Anthracite  
Antracite opaco  
Antrazit matt  
Mat antracit  
مات أنتراسيت

Dark forest mat  
غابة مظلمة

Mint mat  
نعناع

Line  
blanc

Tilt  
chrome

Bend  
noir

poignées / handles

Résistant à l'eau.  
Resistant to water.



Résistant à l'eau.  
Resistant to water.



Composition | blanc mat

2	112 35 060	<b>Module 2 tiroirs 60</b>
	422 02 000	<b>Poignée Line / noir</b>
1	418 00 000	<b>Couvercle siphon</b>
1	506 01 123	<b>Ambar 120 1v. droite</b>
1	290 00 120	<b>Sigma</b>
2	400 02 191	<b>Esther black 45</b>

Auxiliaires

1	112 35 336	<b>Colonne droite</b>
1	112 35 337	<b>Colonne gauche</b>

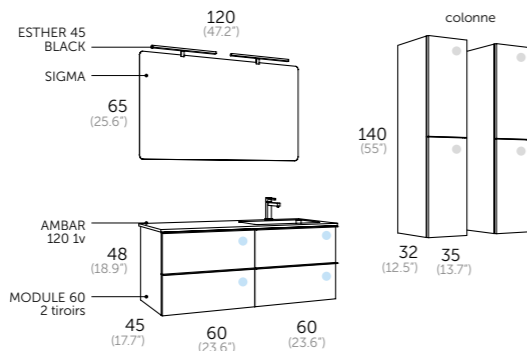

- Glissières métalliques. Metal interior drawers. Sistema di estrazione metallico. Metallzierleiste. Metalen zijkanten. درج معدني
- Extraction e. extraction. Estrazione e. Komplet herausziehbar. Volledig uittrekbaar. لمك جرد حت ف م اظن
- Fermeture ralentie. Soft close. Frenata soft close. Sanfter Verschluss. Zachtsluitend. نظام إغلاق التوماتيكي
- Organisateur. Organizer unit. Organizzatore. Obere Ablage. Superieure organizer. منظم درج علوي
- Glissières Hettich. Hettich sliding system. Guide Hettich. Korpuschiene Hettich. Hettich lade system. مفصلات الجارية هيتش
- Fermeture ralentie. Soft close. Frenata soft close. Sanfter Verschluss. Zachtsluitend. نظام إغلاق التوماتيكي
- Résistant à l'eau. Resistant to water. Idrorepellente. Wasserfest. مقاوم للماء.

# landes.120

## MODULAR

- Line
- Tilt
- Bend
- poignées / handles
- blanc
- chrome
- noir
- Blanc mat  
Matte white  
Bianco opaco  
Weiß matt  
Mat wit  
أبيض مت
- Chêne naturel  
Natural oak  
Rovere naturale  
Natureiche  
Naturale eiken  
بلوط طبيعي
- Pin gris  
Grey pine  
Pino-grigio  
Kiefer grau  
Grijs pijn  
سرو رمادي
- Anthracite mat  
Matte Anthracite  
Antracite opaco  
Antrazit matt  
Mat antracit  
مات أنثرايسيت

- Glissières métalliques. Metal interior drawers. Sistema di estrazione metallico. Metallzierleiste. Metalen zijkanten. درج معدني
- Extraction e. extraction. Estrazione e. Komplet herausziehbar. Volledig uittrekbaar. لمك جرد حت ف م اظن
- Fermeture ralentie. Soft close. Frenata soft close. Sanfter Verschluss. Zachtsluitend. نظام إغلاق التوماتيكي
- Organisateur. Organizer unit. Organizzatore. Obere Ablage. Superieure organizer. منظم درج علوي
- Glissières Hettich. Hettich sliding system. Guide Hettich. Korpuschiene Hettich. Hettich lade system. مفصلات الجارية هيتش
- Mélamine structuré. Textured melamine. Melamina testurizzata. Textur mit Relief. Reliëfstructuur. ملمس منقوش
- Résistant à l'eau. Resistant to water. Idrorepellente. Wasserfest. مقاوم للماء.

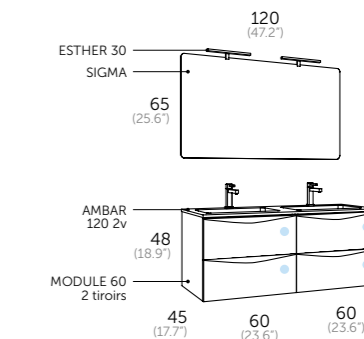

Composition | chêne naturel

2	112 24 060	<b>Module 2 tiroir 60</b>
	420 00 000	<b>Poignée Bend / chrome</b>
1	506 01 122	<b>Ambar 2v.</b>
1	290 00 120	<b>Sigma</b>
2	400 00 121	<b>Esther</b>













Résistant à l'eau.  
Resistant to water.

# landes.120

## MODULAR

- Blanc mat  
Matte white  
Bianco opaco  
Weiß matt  
Mat wit  
أبيض مت
- Chêne naturel  
Natural oak  
Rovere naturale  
Natureiche  
Naturele eiken  
بلوط طبيعي
- Pin gris  
Grey pine  
Pino-grigio  
Kiefer grau  
Grijs pijn  
سرو رمادي
- Anthracite mat  
Matte Anthracite  
Antracite opaco  
Anthraxit matt  
Mat antracit  
مات أنتراسيت
- Dark forest mat  
غابة مظلمة
- Mint mat  
نعناع

-  Glissières métalliques. Metal interior drawers. Sistema di estrazione metallico. Metallzierleiste. Metalen zijkanten. درج معدني
-  Extraction e. extraction. Estrazione e. Komplet herausziehbar. Volledig uittrekbaar. لمك اخرج حث ف ماظن
-  Fermeture ralentie. Soft close. Frenata soft close. Sanfter Verschluss. Zachtsluitend. نظام إغلاق اوماتيكي. نظام إغلاق اوماتيكي
-  Organisateur. Organizer unit. Organizzatore. Obere Ablage. Superieure organizer. منظم درج علوي
-  Glissières Hettich. Hettich sliding system. Guide Hettich. Korpuschiene Hettich. Hettich lade system. مفصلات المانيه هيتش
-  Overture par poussée. Push to open. Sistema Push. Öffnung auf Druck. Push to open. باب دفع
-  Melamine structuré. Textured melamine. Melamina testurizzata. Textur mit Relief. Reliefstructuur. ملمس منقوش
-  Résistant à l'eau. Resistant to water. Idrorepellente. Wasserfest. Waterafstotend. مقاوم للماء

-  Line
  -  Tilt
  -  Bend
- poignées / handles
-  blanc
  -  chrome
  -  noir

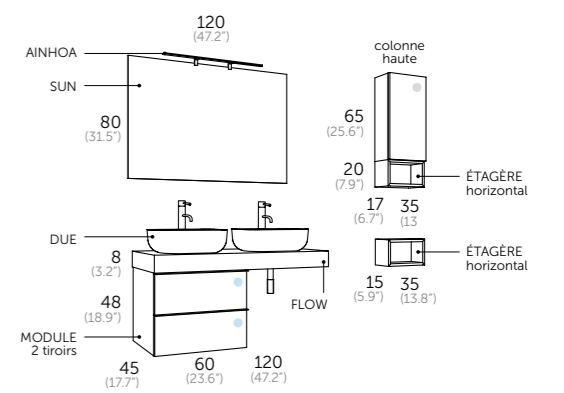

Composition | blanc mat | chêne naturel

1	112 35 060	Module 2 tirors 60
	422 27 000	Poignée Line / blanc
1	138 24 120	Flow 120
1	410 00 101	Siphon chrome
2	530 01 002	Due
1	204 00 120	Sun
1	400 00 151	Ainhua

Auxiliaires

1	112 24 435	Colonne haute
1	112 35 505	Étagère horizontal BM
1	112 24 505	Étagère horizontal CN





Résistant à l'eau.  
Resistant to water.



# landes.130

MODULAR

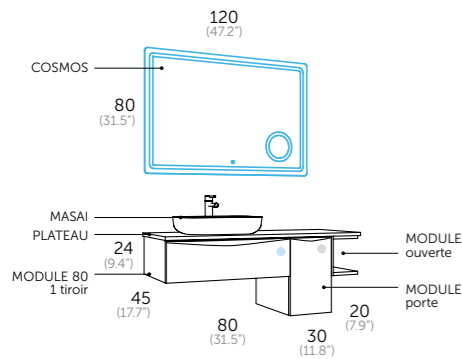

### Composition | pin gris | anthracite mat

1	112 37 083	<b>Module 1 tiroir 80 avec organisateur</b>
1	112 45 030	<b>Module porte 30</b>
	420 02 000	<b>Poignée Bend / noir</b>
1	112 37 026	<b>Module ouverte 20</b>
1	112 37 213	<b>Plateau 130</b>
1	518 02 051	<b>Masai</b>
1	270 00 120	<b>Cosmos</b>



- Blanc mat / Matte white / Bianco opaco / Weiß matt / Mat wit / أبيض مت
- Chêne naturel / Natural oak / Rovere naturale / Natureiche / Naturele eiken / بلوط طبيعي
- Pin gris / Grey pine / Pino-grigio / Kiefer grau / Grijs pijn / سرو رمادي
- Anthracite mat / Matte Anthracite / Antracite opaco / Anthrazit matt / Mat antracit / مات الأنثرايسيت

- Dark forest mat / غابة مظلمة
- Mint mat / نعناع

- Glissières métalliques. Metal interior drawers. Sistema di estrazione metallico. Metallzierleiste. Metalen zijkanten. درج معدني
- Extraction e. extraction. Estrazione e. Komplet herausziehbar. Volledig uittrekbaar. لم اءك ءرد ءءء م اءن
- Fermeture ralentie. Soft close. Frenata soft close. Sanfter Verschluss. Zachtsluitend. نظام إءلق اءوماءيكي
- Organisateur. Organizer unit. Organizzatore. Obere Ablage. Superieure organizer. منظم درء علوي
- Glissières Hettich. Hettich sliding system. Guide Hettich. Korpuschiene Hettich. Hettich lade system. مفصلاء المءاءءهءيش
- Fermeture ralentie. Soft close. Frenata soft close. Sanfter Verschluss. Zachtsluitend. نظام إءلق اءوماءيكي
- Mélamine structuré. Textured melamine. Melamina testunzata. Textur mit Relief. Reliefstructuur. ملمس منقوش
- Résistant à l'eau. Resistant to water. Idrorepellente. Wasserfest. مقاوم للماء
- Système anti buée. Anti fog system. Sistema antiappannamento. Anti Beschlag System. نظام ضد الضباب
- Capteurs de contact. Contact sensor On/Off. Sensore di con tatto On/Off. Sensorschalter On/Off. Aanraken Schakelaar. ءساس لمس اءفاء / ءءءءل
- Miroir loupe 3x éclairé. Magnifying zoom in Mirror. Lente d'ingrandimento 3x. Lupe 3x Vergrößerung. Vergrootglas: verhoging x3. مكبرماءة 3 أضعاف
- Line / Tilt / Bend
- poignées / handles
- blanc / chrome / noir





Résistant à l'eau.  
Resistant to water.



# landes.140

MODULAR

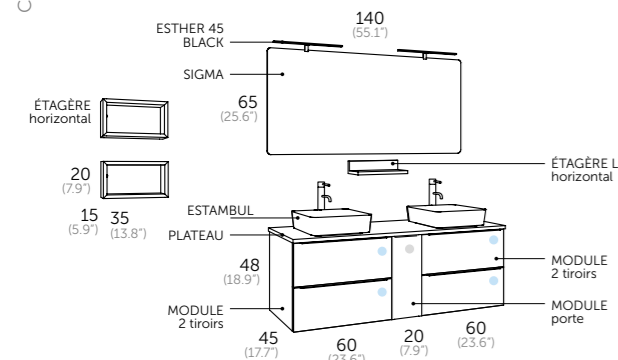

Composition | anthracite mat

2	112 45 060	<b>Module 2 tiroirs 60</b>
1	112 45 020	<b>Module 1 porte 20</b>
1	112 45 214	<b>Plateau 140</b>
	422 02 000	<b>Poignée Line / noir</b>
2	507 01 005	<b>Estambul</b>
1	290 00 140	<b>Sigma</b>
2	400 02 191	<b>Esther black 45</b>

Auxiliaires

2	112 45 505	<b>Étagère horizontale</b>
1	112 45 520	<b>Étagère L horizontale</b>



Glissières métalliques. Metal interior drawers. Sistema di estrazione metallico. Metallizerleiste. Metalen zijkanten. درج معدني

Extraction e. extraction. Estrazione e. Komplet herausziehbar. Volledig uittrekbaar. لم ياك جرد حتف م اظن

Fermeture ralentie. Soft close. Frenata soft dose. Sanfter Verschluss. Zachtsluitend. نظام إغلاق انوماتيكي

Organisateur. Organizer unit. Organizzatore. Obere Ablage. Superieure organizer. منظم درج علوي

Glissières Hettich. Hettich sliding system. Guide Hettich. Korpussschiene Hettich. Hettich lade system. مفصلات المانبة هيتش

Fermeture ralentie. Soft close. Frenata soft dose. Sanfter Verschluss. Zachtsluitend. نظام إغلاق انوماتيكي

Résistant à l'eau. Resistant to water. Idrorepellente. Wasserfest. مقاوم للماء. Waterafstotend.



Blanc mat  
Matte white  
Bianco opaco  
Weiß matt  
Mat wit  
أبيض مت



Chêne naturel  
Natural oak  
Rovere naturale  
Naturele eiken  
بلوط طبيعي



Pin gris  
Grey pine  
Pino-grigio  
Kiefer grau  
Grijs pijn  
سرو رمادي



Anthracite mat  
Matte Anthracite  
Antracite opaco  
Antrazit matt  
Mat antracit  
مات أنتراسيت



Dark forest mat  
غابة مظلمة



Mint mat  
نعناع



Line



Tilt



Bend

poignées / handles



blanc



chrome



noir









Résistant à l'eau.  
Resistant to water.

# landes.140

MODULAR

-  Glissières métalliques. Metal interior drawers. Sistema di estrazione metallico. Metallzieleiste. Metalen zijkanten. درج معدني
-  Extraction e. extraction. Estrazione e. Komplet herausziehbar. Volledig uittrekbaar. لமாக چرد جتاف ماظن
-  Fermeture ralentie. Soft close. Frenata soft close. Sanfter Verschluss. Zachtsluitend. نظام إقلاق اتوماتيكي
-  Organisateur. Organizer unit. Organizzatore. Obere Ablage. Superieure organizer. منظم درج علوي
-  Glissières Hettich. Hettich sliding system. Guide Hettich. Korpuschiene Hettich. Hettich lade system. مفصلات الجانبيه هيتش
-  Mélangine structuré. Textured melamine. Melamina testurizzata. Textur mit Relief. Reliefstructuur. ملمس منقوش
-  Résistant à l'eau. Resistant to water. Idrorepellente. Wasserfest. Waterafstotend. مقاوم للماء
-  Système anti buée. Anti fog system. Sistema antiappannamento. Anti Beschlag System. Spiegeilverwarming. نظام ضد الضباب
-  Réversible. It is reversible. Reversibile. Umkehrbar. Omkeerbaar. ja. استعمال عكسي
-  Capteurs de infrarouge. Infrared sensor On/Off. Sensore infrarosso On/Off. Infrarot Sensorschalter On/Off. Infrarood sensor. حساس بلوتوث اطفاء / تشغيل

-  Line
  -  Tilt
  -  Bend
- poignées / handles
-  blanc
  -  chrome
  -  noir

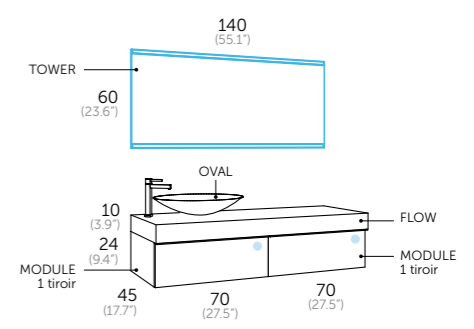

Composition | blanc mat | chêne naturel

1	112 35 073	<b>Module 1 tiroir 70 avec organisateur</b>
1	112 35 074	<b>Module 1 tiroir 70</b>
	422 02 000	<b>Poignée Line / noir</b>
1	138 24 140	<b>Flow 140</b>
1	509 01 001	<b>Oval</b>
1	262 00 140	<b>Tower</b>

-  Blanc mat  
Matte white  
Bianco opaco  
Weiß matt  
Mat wit  
أبيض مت
-  Chêne naturel  
Natural oak  
Rovere naturale  
Naturliche  
Naturel eiken  
بلوط طبيعي
-  Pin gris  
Grey pine  
Pino-grigio  
Kiefer grau  
Grijs pijn  
سرو رمادي
-  Anthracite mat  
Matte Anthracite  
Antracite opaco  
Anthraxil matt  
Mat antracit  
مات أنتراسيت



Résistant à l'eau.  
Resistant to water.

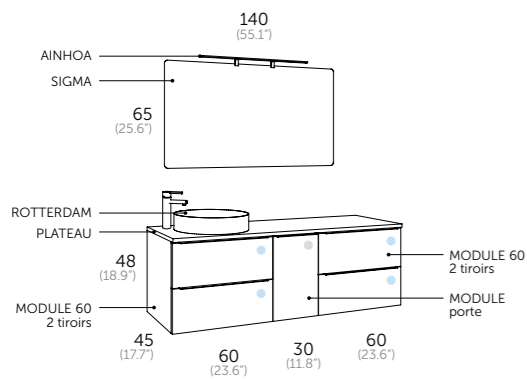

Composition | chêne naturel

2	112 24 060	<b>Module 2 tiroirs 60</b>
1	418 00 000	<b>Couvercle siphon</b>
1	112 24 030	<b>Module porte 30</b>
	420 00 000	<b>Poignée Bend / chrome</b>
1	112 24 215	<b>Plateau 150</b>
1	507 01 004	<b>Rotterdam</b>
1	290 00 140	<b>Sigma</b>
1	400 00 151	<b>Ainhoa</b>



- Glissières métalliques. Metal interior drawers. Sistema di estrazione metallico. Metallizerleiste. Metalen zijkanten. درج معدني
- Extraction e. extraction. Estrazione e. Komplett herausziehbar. Volledig uittrekbaar. لهماك جرد حتف ماظن
- Fermeture ralentie. Soft close. Frenata soft close. Sanfter Verschluss. Zachtsluitend. نظام إغلاق انوماتيكي
- Organisateur. Organizer unit. Organizzatore. Obere Ablage. Superieure organizer. منظم درج علوي
- Glissières Hettich. Hettich sliding system. Guide Hettich. Korpuschiene Hettich. Hettich lade system. مفصلات الجانبة هيتش
- Fermeture ralentie. Soft close. Frenata soft close. Sanfter Verschluss. Zachtsluitend. نظام إغلاق انوماتيكي
- Mèlamine structuré. Textured melamine. Melamina testurizzata. Textur mit Relief. Reliefsstruktur. ملمس منقوش
- Résistant à l'eau. Resistant to water. Idrorepellente. Wasserfest. مقاوم للماء

# landes.150

## MODULAR

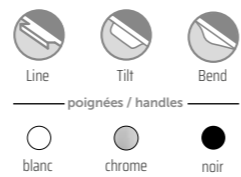



Résistant à l'eau.  
Resistant to water.



- Line
  - Tilt
  - Bend
- poignées / handles
- blanc
  - chrome
  - noir



Blanc mat  
Matte white  
Bianco opaco  
Weiß matt  
Mat wit  
أبيض مت



Chêne naturel  
Natural oak  
Rovere naturale  
Natureiche  
Naturele eiken  
بلوط طبيعي



Pin gris  
Grey pine  
Pino-grigio  
Kiefer grau  
Grijs pijn  
سرو رمادي



Anthracite mat  
Matte Anthracite  
Antracite opaco  
Anthraxit matt  
Mat antracit  
مات أنتراسيت



Dark forest mat  
غاية مظلمة



Mint mat  
نعناع



# landes.150

MODULAR

- Glissières métalliques. Metal interior drawers. Sistema di estrazione metallico. Metallzieleiste. Metalen zijkanten. درج معدني
- Extraction e. extraction. Estrazione e. Komplet herausziehbar. Volledig uittrekbaar. لم اك جرد حت ف ماظن
- Fermeture ralentie. Soft close. Frenata soft close. Sanfter Verschluss. Zachtsluitend. نظام إغلاق التوماتيكي
- Organisateur. Organizer unit. Organizzatore. Obere Ablage. Superieure organizer. منظم درج علوي
- Glissières Hettich. Hettich sliding system. Guide Hettich. Korpuschiene Hettich. Hettich lade system. مفصلات المانيهتيتش
- Mélamine structuré. Textured melamine. Melamina testurizzata. Textur mit Relief. Reliefstructuur. ملمس منشوش
- Overture par poussée. Push to open. Sistema Push. Öffnung auf Druck. Push to open. باب دفع
- Résistant à l'eau. Resistant to water. Idrorepellente. Wasserfest. Waterafstotend. مقاوم للماء

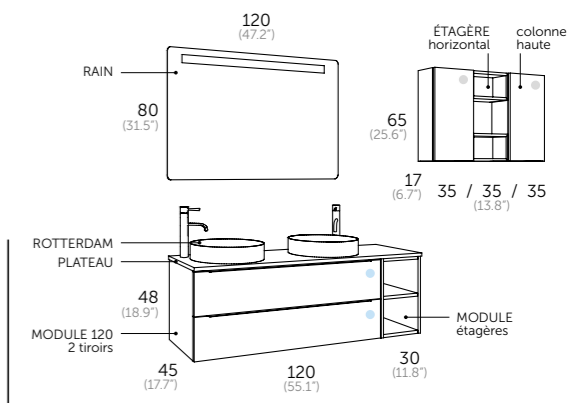

Composition | pin gris | dark forest mat

1	112 37 120	Module 2 tiroirs 120
1	112 29 000	Module étagères
	421 00 000	Poignée Tilt / chrome
1	112 37 215	Plateau 150
2	507 01 004	Rotterdam
1	269 00 120	Rain

Auxiliaires

2	112 37 435	Colonne haute
2	112 29 505	Étagère horizontale













Résistant à l'eau.  
Resistant to water.

# landes.160

MODULAR

-  Glissières métalliques. Metal interior drawers. Sistema di estrazione metallo. Metallzierleiste. Metalen zijkanten. درج معدني
-  Extraction e. extraction. Estrazione e. Komplet herausziehbar. Volledig uittrekbaar. لمحرك جرد حثاف ماظن
-  Fermeture ralentie. Soft close. Frenata soft close. Sanfter Verschluss. Zachtsluitend. نظام إغلاق اتوماتيكي
-  Organisateur. Organizer unit. Organizzatore. Obere Ablage. Superieure organizer. منظم درج علوي
-  Glissières Hettich. Hettich sliding system. Guide Hettich. Korpuschiene Hettich. Hettich lade system. مفصلات الملية هيتش
-  Fermeture ralentie. Soft close. Frenata soft close. Sanfter Verschluss. Zachtsluitend. نظام إغلاق اتوماتيكي
-  Overture par poussée. Push to open. Sistema Push. Öffnung auf Druck. Push to open. باب دفع
-  Résistant à l'eau. Resistant to water. Idrorepellente. Wasserfest. Waterafstotend. مقاوم للماء
-  Système anti buée. Anti fog system. Sistema antiappannamento. Anti Beschlag System. نظام ضد الضباب
-  Lumière ambient. Ambient light. Luce ambiente. Ambient Light. اضاءة خلفية
-  Capteurs de contact. Contact sensor On/Off. Sensore di con tatto On/Off. Sensorschalter On/Off. Aanraken Schakelaar. حساس لمس انفتاح / تشغيل
-  Réversible. It is reversible. Reversibile. Umkehrbar. Omkeerbaar. ja استعمال عكسي

-  Line
  -  Tilt
  -  Bend
- poignées / handles
-  blanc
  -  chrome
  -  noir

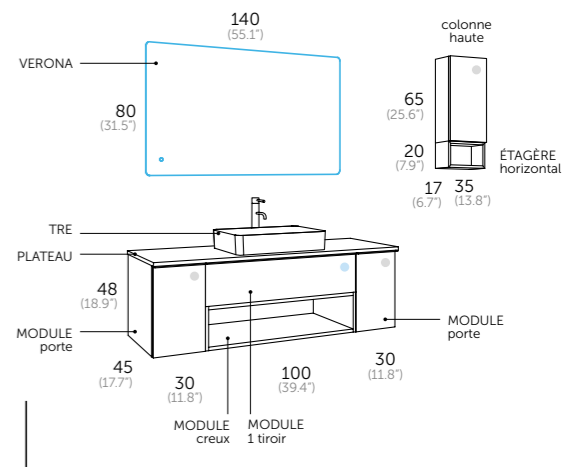

Composition | blanc mat | anthracite mat

1	112 35 103	<b>Module 1 tiroir 100 avec organisateur</b>
2	112 35 030	<b>Module porte 30</b>
	422 02 000	<b>Poignée Line / noir</b>
1	112 45 105	<b>Module creux 100</b>
1	112 35 216	<b>Plateau 160</b>
1	530 01 036	<b>Tre</b>
1	246 00 140	<b>Verona</b>

Auxiliaires

1	112 35 435	<b>Colonne haute</b>
1	112 45 505	<b>Étagère horizontal</b>

-  Blanc mat  
Matte white  
Bianco opaco  
Weiß matt  
Mat wit  
أبيض مت
-  Chêne naturel  
Natural oak  
Rovere naturale  
Natureiche  
Naturel eiken  
بلوط طبيعي
-  Pin gris  
Grey pine  
Pino-grigio  
Kiefer grau  
Grijs pijn  
سرو رمادي
-  Anthracite mat  
Matte Anthracite  
Antracite opaco  
Anthraxit matt  
Mat antracit  
مات أنتراسيت
-  Dark forest mat  
غابة مظلمة
-  Mint mat  
نعناع



Résistant à l'eau.  
Resistant to water.



# landes.180

MODULAR

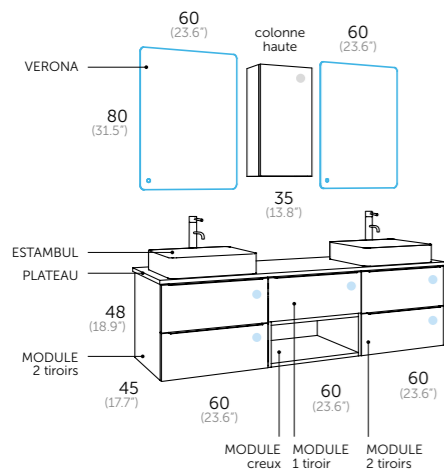

Composition | pin gris | anthracite mat

2	112 37 060	Module 2 tiroirs 60
1	112 37 064	Module 1 tiroir 60
1	112 45 218	Plateau 180
1	112 45 065	Module creux 60
	422 00 000	Poignée Line / chrome
2	507 01 005	Estambul
2	246 00 060	Verona

Auxiliaires

1	112 37 435	Colonne haute
---	------------	---------------



- Glissières métalliques. Metal interior drawers. Sistema di estrazione metallico. Metallzierleiste. Metalen zijkanten. درج معدني
- Extraction e. extraction. Estrazione e. Komplet herausziehbar. Volledig uittrekbaar. لم ياك جرد حت ف م اظن
- Fermeture ralentie. Soft close. Frenata soft close. Sanfter Verschluss. Zachtsluitend. نظام إغلاق أوتوماتيكي
- Organisateur. Organizer unit. Organizzatore. Obere Ablage. Superieure organizer. منظم درج علوي
- Glissières Hettich. Hettich sliding system. Guide Hettich. Korpuschiene Hettich. Hettich lade system. مفصلات المانحة هيتش
- Overture par poussée. Push to open. Sistema Push. Öffnung auf Druck. Push to open. باب دفع
- Melamine structuré. Textured melamine. Melamina testurizzata. Textur mit Relief. Reliefstructuur. ملمس متقوس
- Résistant à l'eau. Resistant to water. Idrorepellente. Wasserfest. Waterafstotend. مقاوم للماء
- Système anti buée. Anti fog system. Sistema antiappannamento. Anti Beschlag System. نظام ضد الضباب. Spiegelfverwarming
- Lumière ambiant. Ambient light. Luce ambiente. Ambient Light. أضواء خلفية. Omgevingslicht
- Capteurs de contact. Contact sensor On/Off. Sensore di con tatto On/Off. Sensorschalter On/Off. Aanraken Schakelaar. حساس لمس اضغطاء / تشغيل
- Réversible. It is reversible. Reversibile. Umkehrbar. Omkeerbaar. ja. استعمال عكسي



Blanc mat  
Matte white  
Bianco opaco  
Weiß matt  
Mat wit  
أبيض مت



Chêne naturel  
Natural oak  
Rovere naturale  
Naturele eiken  
بلوط طبيعي



Pin gris  
Grey pine  
Pino-grigio  
Kiefer grau  
Grijs pijn  
سرو رمادي



Anthracite mat  
Matte Anthracite  
Antracite opaco  
Antracit matt  
Mat antracit  
مات أنتراسيت



Line



Tilt



Bend

poignées / handles



blanc



chrome



noir



Résistant à l'eau.  
Resistant to water.



# landes.180

## MODULAR

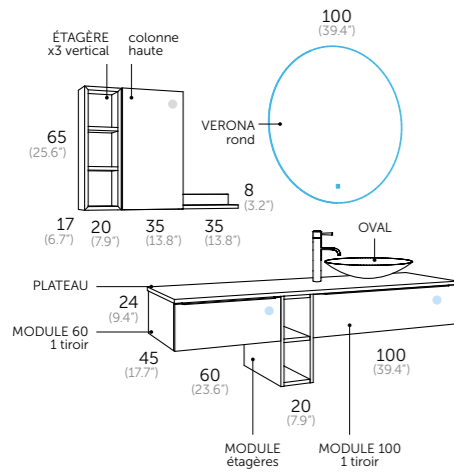

Composition | chêne naturel | mint | dark forest

1	112 24 064	Module 1 tiroir 60
1	112 24 103	Module 1 tiroir 100 avec organisateur
	421 02 000	Poignée Tilt / noir
1	112 29 022	Module étagères 20
1	112 24 218	Plateau 180
1	509 01 001	Oval
1	247 00 100	Verona rond

Auxiliaires

1	112 28 500	Étagère x3 vertical
1	112 24 435	Colonne haute
1	112 29 520	Étagère L horizontal



Blanc mat Matte white Bianco opaco Weiß matt Mat wit أبيض مت	Chêne naturel Natural oak Rovere naturale Natureiche Naturel eiken بلوط طبيعي	Pin gris Grey pine Pino-grigio Kiefer grau Grijs pijn سرو رمادي	Anthracite mat Matte Anthracite Antracite opaco Anthraxit matt Mat antracit مات أنتراسيت
---	--	--	---

Dark forest mat غابة مظلمة	Mint mat نعناع
-------------------------------	-------------------

- Glissières métalliques. Metal interior drawers. Sistema di estrazione metallico. Metallzierleiste. Metalen zijkanten. درج معدني
- Extraction e. extraction. Estrazione e. Komplet herausziehbar. Volledig uittrekbaar. لمداك جرد حرتف ماظن
- Fermeture ralentie. Soft close. Frenata soft close. Sanfter Verschluss. Zachtsluitend. نظام إغلاق التوماتيكي
- Organisateur. Organizer unit. Organizzatore. Obere Ablage. Superieure organizer. منظم درج علوي
- Glissières Hettich. Hettich sliding system. Guide Hettich, Korpuschiene Hettich. Hettich lade system. مفصلات الجارية هتيتش
- Overture par poussée. Push to open. Sistema Push. Öffnung auf Druck. Push to open. باب دفع
- Mélamine structuré. Textured melamine. Melamina testurizzata. Textur mit Relief. Reliefstruuktur. ملمس منقوش
- Résistant à l'eau. Resistant to water. Idrorepellente. Wasserfest. مقاوم للماء
- Système anti buée. Anti fog system. Sistema antiappannamento. Anti Beschlag System. نظام ضد الضباب
- Lumière ambient. Ambient light. Luce ambiente. Ambient Light. اضاءة خلفية
- Capteurs de contact. Contact sensor On/Off. Sensore di con tatto On/Off. Sensorschalter On/Off. Aanraken Schakelaar. حساس لمس اظفاه / تشفير
- Line
- Tilt
- Bend
- poignées / handles
- blanc
- chrome
- noir





Résistant à l'eau.  
Resistant to water.



# landes.200

MODULAR

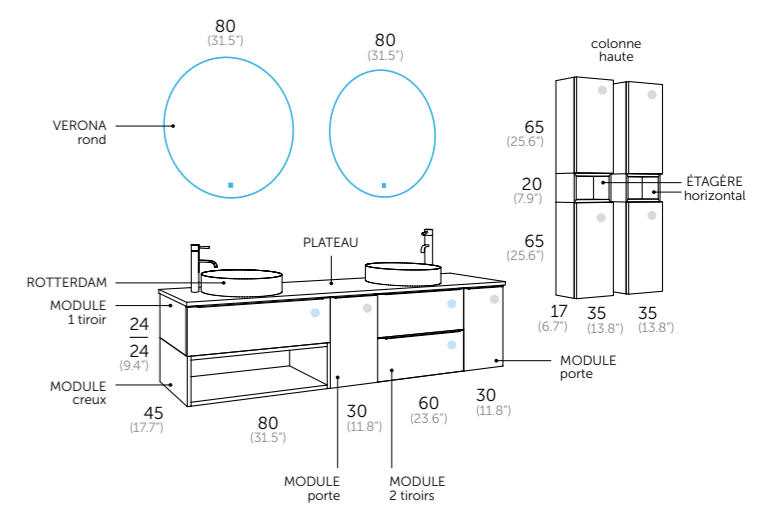

Composition | chêne naturel | anthracite mat

1	112 24 083	<b>Module 1 tiroir 80 avec organisateur</b>
1	112 24 030	<b>Module porte 30 CN</b>
1	112 45 030	<b>Module porte 30 AM</b>
1	112 24 060	<b>Module 2 tiroirs 60</b>
	421 27 000	<b>Poignée Tilt / blanc</b>
1	112 45 085	<b>Module creux 80</b>
1	112 24 220	<b>Plateau 200</b>
2	507 01 004	<b>Rotterdam</b>
2	247 00 080	<b>Verona rond</b>

Auxiliaires

4	112 24 435	<b>Colonne haute</b>
2	112 45 505	<b>Étagère horizontale</b>





# Idées de composition

Prix avec plateau. Price with top.

# landes.

MODULAR



## 60 (23.6")



## 70 (27.6")

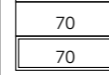

## 80 (31.5")

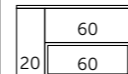
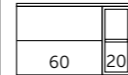
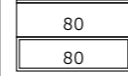
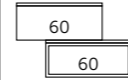

## 160 (63")

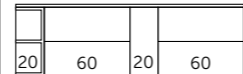
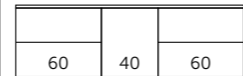
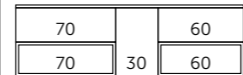
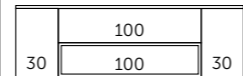
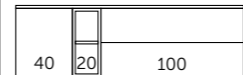
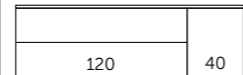
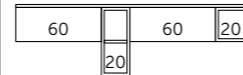

## 90 (35.4")

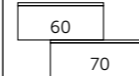
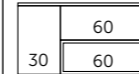
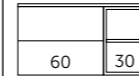
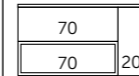
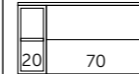

## 170 (67")

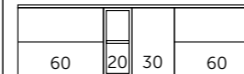
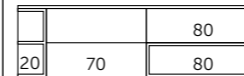
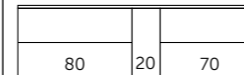
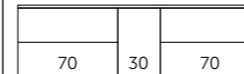
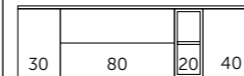
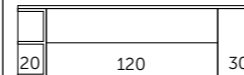
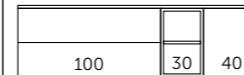
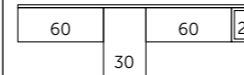
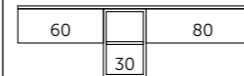

## 100 (39.4")

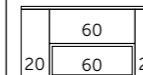
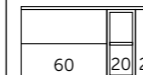
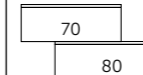
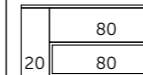
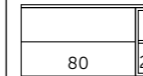
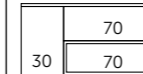
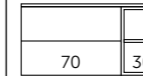
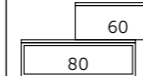
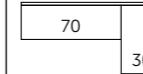

## 180 (70.9")

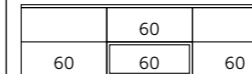
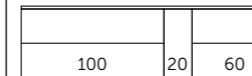
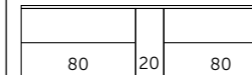
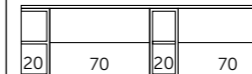
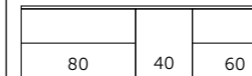
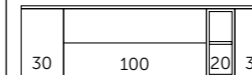
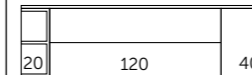
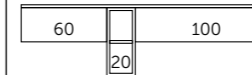
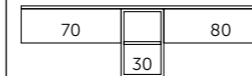

## 110 (43.3")

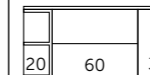
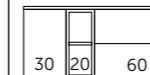
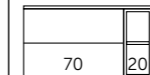
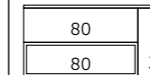
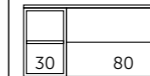
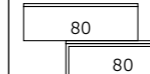
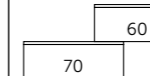
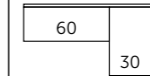
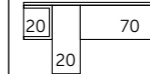

## 190 (74.8")

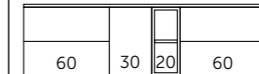
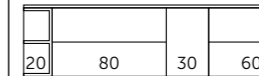
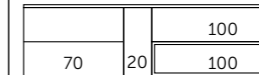
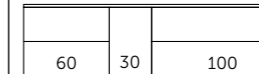
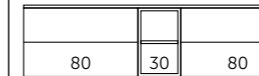
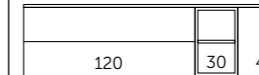
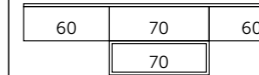
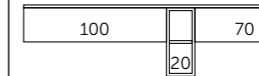

## 120 (47.2")

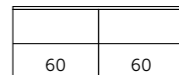
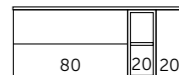
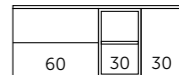
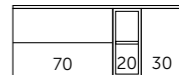
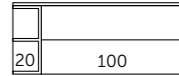
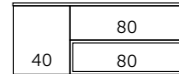
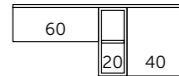
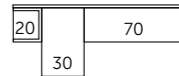
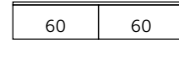

## 200 (78.7")

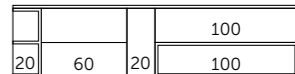
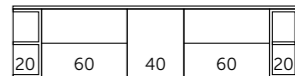
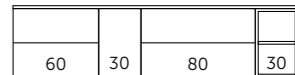
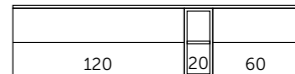
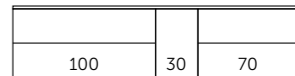
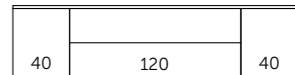
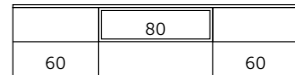
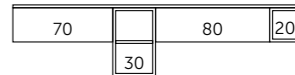

## 130 (51.2")

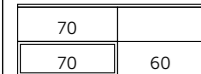
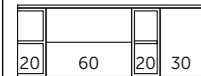
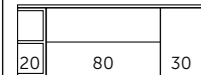
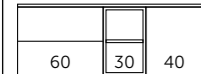
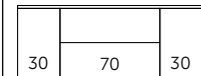
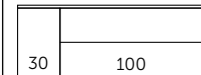
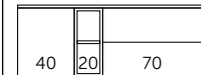
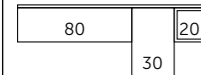
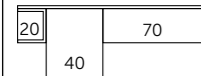

## 140 (55.1")

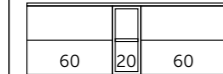
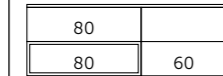
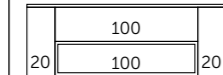
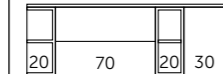
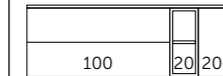
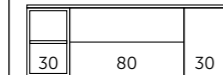
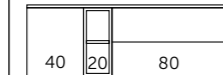
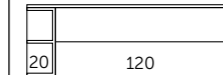
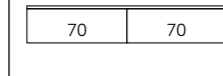

## 150 (59")

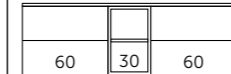
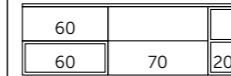
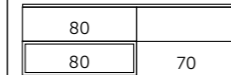
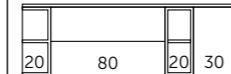
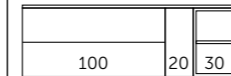
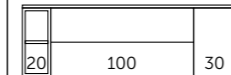
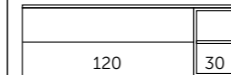
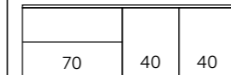
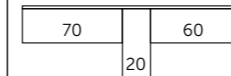



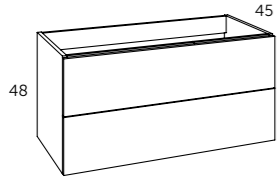

### Module 2 tiroirs

#### 60 (23,4")

Finition	Référence
○ Blanc mat	112 35 060
● Chêne naturel	112 24 060
● Pin gris	112 37 060
● Anthracite mat	112 45 060

#### 70 (27,5")

Finition	Référence
○ Blanc mat	112 35 070
● Chêne naturel	112 24 070
● Pin gris	112 37 070
● Anthracite mat	112 45 070

#### 80 (31,5")

Finition	Référence
○ Blanc mat	112 35 080
● Chêne naturel	112 24 080
● Pin gris	112 37 080
● Anthracite mat	112 45 080

#### 100 (39,4")

Finition	Référence
○ Blanc mat	112 35 100
● Chêne naturel	112 24 100
● Pin gris	112 37 100
● Anthracite mat	112 45 100

#### 120 (47,2")

Finition	Référence
○ Blanc mat	112 35 120
● Chêne naturel	112 24 120
● Pin gris	112 37 120
● Anthracite mat	112 45 120



### couverture siphon en option

Il couvre le creux du siphon quand il n'a pas de plan vasque.  
Covers the siphon hole when it does not have a washbasin.

Référence  
418 00 000

### Module 1 tiroir siphon trou et organisateur

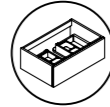

#### 60 (23,4")

Finition	Référence
○ Blanc mat	112 35 063
● Chêne naturel	112 24 063
● Pin gris	112 37 063
● Anthracite mat	112 45 063

#### 70 (27,5")

Finition	Référence
○ Blanc mat	112 35 073
● Chêne naturel	112 24 073
● Pin gris	112 37 073
● Anthracite mat	112 45 073

#### 80 (31,5")

Finition	Référence
○ Blanc mat	112 35 083
● Chêne naturel	112 24 083
● Pin gris	112 37 083
● Anthracite mat	112 45 083

#### 100 (39,4")

Finition	Référence
○ Blanc mat	112 35 103
● Chêne naturel	112 24 103
● Pin gris	112 37 103
● Anthracite mat	112 45 103



# landes.

MODULAR

### Module 1 tiroir

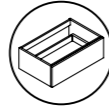

#### 60 (23,4")

Finition	Référence
○ Blanc mat	112 35 064
● Chêne naturel	112 24 064
● Pin gris	112 37 064
● Anthracite mat	112 45 064

#### 70 (27,5")

Finition	Référence
○ Blanc mat	112 35 074
● Chêne naturel	112 24 074
● Pin gris	112 37 074
● Anthracite mat	112 45 074

#### 80 (31,5")

Finition	Référence
○ Blanc mat	112 35 084
● Chêne naturel	112 24 084
● Pin gris	112 37 084
● Anthracite mat	112 45 084

#### 100 (39,4")

Finition	Référence
○ Blanc mat	112 35 104
● Chêne naturel	112 24 104
● Pin gris	112 37 104
● Anthracite mat	112 45 104



### Module creux



#### 60 (23,4")

Finition	Référence
○ Blanc mat	112 35 065
● Chêne naturel	112 24 065
● Pin gris	112 37 065
● Anthracite mat	112 45 065

#### 70 (27,5")

Finition	Référence
○ Blanc mat	112 35 075
● Chêne naturel	112 24 075
● Pin gris	112 37 075
● Anthracite mat	112 45 075

#### 80 (31,5")

Finition	Référence
○ Blanc mat	112 35 085
● Chêne naturel	112 24 085
● Pin gris	112 37 085
● Anthracite mat	112 45 085

#### 100 (39,4")

Finition	Référence
○ Blanc mat	112 35 105
● Chêne naturel	112 24 105
● Pin gris	112 37 105
● Anthracite mat	112 45 105

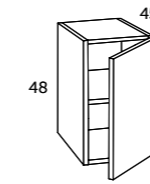

### Module porte | Réversible

#### 20 (7,9")

Finition	Référence
○ Blanc mat	112 35 020
● Chêne naturel	112 24 020
● Pin gris	112 37 020
● Anthracite mat	112 45 020

#### 30 (11,8")

Finition	Référence
○ Blanc mat	112 35 030
● Chêne naturel	112 24 030
● Pin gris	112 37 030
● Anthracite mat	112 45 030

#### 40 (15,7")

Finition	Référence
○ Blanc mat	112 35 040
● Chêne naturel	112 24 040
● Pin gris	112 37 040
● Anthracite mat	112 45 040

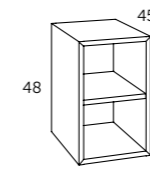

### Module étagères

#### 20 (7,9")

Finition	Référence
○ Blanc mat	112 35 022
● Chêne naturel	112 24 022
● Pin gris	112 37 022
● Mint mat	112 28 022
● Dark forest mat	112 29 022
● Anthracite mat	112 45 022

#### 21 - 35\* (8,3 - 13,8")

Finition	Référence
○ Blanc mat	112 35 000
● Chêne naturel	112 24 000
● Pin gris	112 37 000
● Mint mat	112 28 000
● Dark forest mat	112 29 000
● Anthracite mat	112 45 000

\*Module étagères fabrication cm à cm. De 21 à 35 cm.  
Sur demande. Délai de livraison 25 jours.

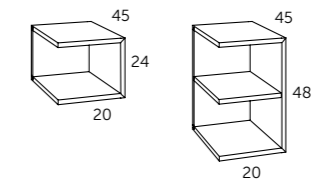

### Module étagère ouverte

#### 1 étagère

Finition	Référence
○ Blanc mat	112 35 026
● Chêne naturel	112 24 026
● Pin gris	112 37 026
● Mint mat	112 28 026
● Dark forest mat	112 29 026
● Anthracite mat	112 45 026

#### 2 étagères

Finition	Référence
○ Blanc mat	112 35 025
● Chêne naturel	112 24 025
● Pin gris	112 37 025
● Mint mat	112 28 025
● Dark forest mat	112 29 025
● Anthracite mat	112 45 025

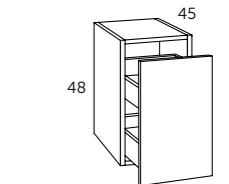

### Module double tiroir

#### 30 (11,8")

Finition	Référence
○ Blanc mat	112 35 034
● Chêne naturel	112 24 034
● Pin gris	112 37 034
● Anthracite mat	112 45 034

## Auxiliaires.

auxiliary units / armadietti / hängeschränke / aanvullende artikelen / وحدات جانبية

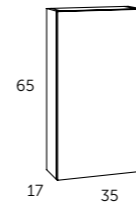

### Colonne haute | Réversible

Finition	Référence
○ Blanc mat	112 35 435
● Chêne naturel	112 24 435
● Pin gris	112 37 435
● Anthracite mat	112 45 435

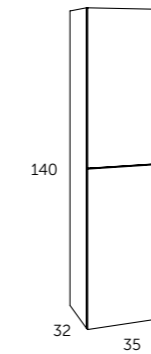

### Colonne

Finition	Droite	Gauche
○ Blanc mat	112 35 336	112 35 337
● Chêne naturel	112 24 336	112 24 337
● Pin gris	112 37 336	112 37 337
● Anthracite mat	112 45 336	112 45 337

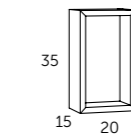

### étagère vertical

Finition	Référence
○ Blanc mat	112 35 510
● Chêne naturel	112 24 510
● Pin gris	112 37 510
● Mint mat	112 28 510
● Dark forest mat	112 29 510
● Anthracite mat	112 45 510

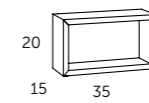

### étagère horizontal

Finition	Référence
○ Blanc mat	112 35 505
● Chêne naturel	112 24 505
● Pin gris	112 37 505
● Mint mat	112 28 505
● Dark forest mat	112 29 505
● Anthracite mat	112 45 505

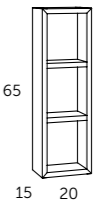

### étagère x3 vertical

Finition	Référence
○ Blanc mat	112 35 500
● Chêne naturel	112 24 500
● Pin gris	112 37 500
● Mint mat	112 28 500
● Dark forest mat	112 29 500
● Anthracite mat	112 45 500

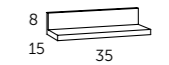

### étagère "L"

Finition	Référence
○ Blanc mat	112 35 520
● Chêne naturel	112 24 520
● Pin gris	112 37 520
● Mint mat	112 28 520
● Dark forest mat	112 29 520
● Anthracite mat	112 45 520

### Poignées

● Chrome ○ Blanc ● Noir

#### Bend



Finition	Référence
● Chrome	420 00 000
○ Blanc	420 27 000
● Noir	420 02 000

#### Tilt



Finition	Référence
● Chrome	421 00 000
○ Blanc	421 27 000
● Noir	421 02 000

#### Line



Finition	Référence
● Chrome	422 00 000
○ Blanc	422 27 000
● Noir	422 02 000





**Plateaux landes**  
avec barre de renfort en aluminium



- |  |   |
|--|---|
| <b>60</b> (23,4")<br>Finition<br>○ Blanc mat 112 35 206<br>● Chêne naturel 112 24 206<br>● Pin gris 112 37 206<br>● Anthracite mat 112 45 206  | <b>130</b> (51,2")<br>Finition<br>○ Blanc mat 112 35 213<br>● Chêne naturel 112 24 213<br>● Pin gris 112 37 213<br>● Anthracite mat 112 45 213  |
| <b>70</b> (27,5")<br>Finition<br>○ Blanc mat 112 35 207<br>● Chêne naturel 112 24 207<br>● Pin gris 112 37 207<br>● Anthracite mat 112 45 207  | <b>140</b> (55,1")<br>Finition<br>○ Blanc mat 112 35 214<br>● Chêne naturel 112 24 214<br>● Pin gris 112 37 214<br>● Anthracite mat 112 45 214  |
| <b>80</b> (31,5")<br>Finition<br>○ Blanc mat 112 35 208<br>● Chêne naturel 112 24 208<br>● Pin gris 112 37 208<br>● Anthracite mat 112 45 208  | <b>150</b> (59")<br>Finition<br>○ Blanc mat 112 35 215<br>● Chêne naturel 112 24 215<br>● Pin gris 112 37 215<br>● Anthracite mat 112 45 215  |
| <b>90</b> (35,4")<br>Finition<br>○ Blanc mat 112 35 209<br>● Chêne naturel 112 24 209<br>● Pin gris 112 37 209<br>● Anthracite mat 112 45 209  | <b>160</b> (63")<br>Finition<br>○ Blanc mat 112 35 216<br>● Chêne naturel 112 24 216<br>● Pin gris 112 37 216<br>● Anthracite mat 112 45 216  |
| <b>100</b> (39,4")<br>Finition<br>○ Blanc mat 112 35 211<br>● Chêne naturel 112 24 210<br>● Pin gris 112 37 210<br>● Anthracite mat 112 45 210 | <b>180</b> (71")<br>Finition<br>○ Blanc mat 112 35 218<br>● Chêne naturel 112 24 218<br>● Pin gris 112 37 218<br>● Anthracite mat 112 45 218  |
| <b>110</b> (43,3")<br>Finition<br>○ Blanc mat 112 35 211<br>● Chêne naturel 112 24 211<br>● Pin gris 112 37 211<br>● Anthracite mat 112 45 211 | <b>200</b> (79,7")<br>Finition<br>○ Blanc mat 112 35 220<br>● Chêne naturel 112 24 220<br>● Pin gris 112 37 220<br>● Anthracite mat 112 45 220  |
| <b>120</b> (47,2")<br>Finition<br>○ Blanc mat 112 35 212<br>● Chêne naturel 112 24 212<br>● Pin gris 112 37 212<br>● Anthracite mat 112 45 212 | <b>cm linéaire</b><br>Finition<br>○ Blanc mat 112 35 999<br>● Chêne naturel 112 24 999<br>● Pin gris 112 37 999<br>● Anthracite mat 112 45 999<br>Sur demande. Délai de livraison 25 jours. |

**Flow**

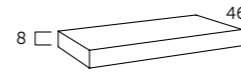

- |   |   |
|---|---|
| <b>60</b> (23,4")<br>Finition<br>● Chêne naturel 138 24 060<br>● Pin gris 138 37 060  | <b>100</b> (39,4")<br>Finition<br>● Chêne naturel 138 24 100<br>● Pin gris 138 37 100 |
| <b>70</b> (27,55")<br>Finition<br>● Chêne naturel 138 24 070<br>● Pin gris 138 37 070 | <b>120</b> (47,2")<br>Finition<br>● Chêne naturel 138 24 120<br>● Pin gris 138 37 120 |
| <b>80</b> (31,5")<br>Finition<br>● Chêne naturel 138 24 080<br>● Pin gris 138 37 080  | <b>140</b> (55,1")<br>Finition<br>● Chêne naturel 138 24 140<br>● Pin gris 138 37 140 |



**Plateau masai**



**Noir**

- |           |            |
|-----------|------------|
| Dimension | Référence  |
| 60        | 519 02 060 |
| 70        | 519 02 070 |
| 80        | 519 02 080 |
| 90        | 519 02 090 |
| 100       | 519 02 100 |
| 120       | 519 02 120 |
| 140       | 519 02 140 |
| 150       | 519 02 150 |
| 160       | 519 02 160 |
| 180       | 519 02 180 |
| 200       | 519 02 200 |

**Vasque à poser**

- |   |  |   |
|---|--|---|
| <b>rotterdam</b><br>céramique<br>Référence 507 01 004                               | <b>estambul</b><br>céramique<br>Référence 507 01 005 | <b>sei</b><br>céramique<br>Référence 530 01 006   |
| <b>tre</b><br>céramique<br>Dimension 51x35 61x35<br>Référence 530 01 035 530 01 036 | <b>due</b><br>céramique<br>Référence 530 01 002      | <b>nove</b><br>céramique<br>Dimension 41x42 50x42 60x42<br>Référence 530 01 094 530 01 095 530 01 096 |
| <b>otto</b><br>céramique<br>Référence 530 01 008                                    | <b>oval</b><br>solid surface<br>Référence 509 01 001 | <b>masai</b><br>Résine revêtue polyuréthane<br>Référence 518 02 051<br>Plus de couleurs à la page 289 |

**Appliques**

- |  |  |  |
|--|--|--|
| <b>esther.30</b><br>Référence 400 00 121       | <b>sofia.60</b><br>Référence 400 00 141        | <b>ainhoa.74</b><br>Référence 400 00 151 |
| <b>esther black.30</b><br>Référence 400 02 121 | <b>esther black.45</b><br>Référence 400 02 191 | <b>nikita</b><br>Référence 400 01 171    |

**Ambar**



- |             |            |     |
|-------------|------------|-----|
| 60          | 506 01 060 |     |
| 70          | 506 01 070 |     |
| 80          | 506 01 080 |     |
| 100         | 506 01 100 |     |
| 120         | 506 01 120 |     |
| 120         | 506 01 122 |     |
| 140         | 506 01 142 |     |
| 80 (60+20)  | 506 01 081 |     |
| 90 (70+20)  | 506 01 092 |     |
| 90 (60+30)  | 506 01 091 |     |
| 100 (70+30) | 506 01 107 |     |
| 110 (80+30) | 506 01 112 |     |
| 120 (60+60) | 506 01 121 |     |
| 140 (70+70) | 506 01 143 |     |
| 80 (20+60)  | 506 01 083 |     |
| 90 (20+70)  | 506 01 094 |     |
| 90 (30+60)  | 506 01 093 |     |
| 100 (30+70) | 506 01 108 |     |
| 110 (30+80) | 506 01 114 |     |
| 120 (60+60) | 506 01 123 |     |
| 140 (70+70) | 506 01 144 |     |
| 60          | 508 01 060 | 230 |
| 70          | 508 01 070 | 240 |
| 80          | 508 01 080 | 250 |
| 100         | 508 01 100 | 270 |
| 120         | 508 01 120 | 290 |
| 140         | 508 01 140 | 330 |

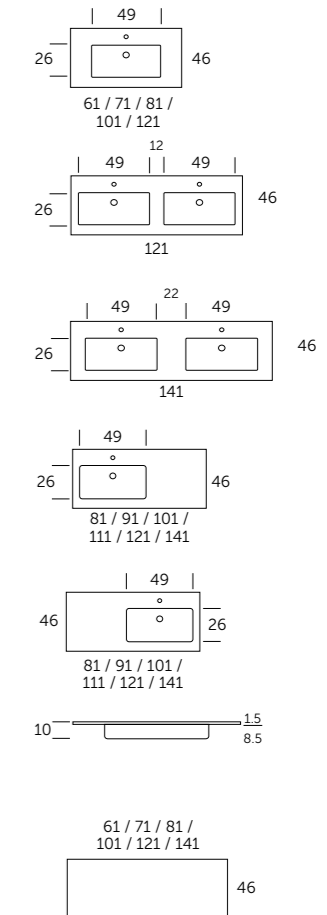

**Robinetterie**



- |               |            |
|---------------|------------|
| <b>combi</b>  | Référence  |
| Chrome        | 412 00 800 |
| Blanc         | 412 01 800 |
| Noir          | 412 02 800 |
| Chêne naturel | 412 24 800 |

**Miroirs**



Résistant à l'eau.  
Resistant to water.



# sigma.

80 / 100 / 120 / 140







Glissières métalliques. Metal interior drawers. Sistema di estrazione metallico. Metallzierleiste. Metalen zijkanten. درج معدني



Extraction e. extraction. Estrazione e. Komplette herausziehbar. Volledig uittrekbaar. لمك جرد حتف ماظن



Fermeture ralentie. Soft close. Frenata soft close. Sanfter Verschluss. Zachtsluitend. نظام إغلاق انوماتيكي



Glissières Hettich. Hettich sliding system. Guide Hettich. Korpuschiene Hettich. Hettich lade system. مفصلات الجانية هيتش



Fermeture ralentie. Soft close. Frenata soft close. Sanfter Verschluss. Zachtsluitend. نظام إغلاق انوماتيكي



Laquéé mate. Matte lacquered finish. Laccato opaco. Matt lackiert. Mat gelakt. مت غامق



Résistant à l'eau. Resistant to water. Idrorepellente. Wasserfest. Waterafstotend. مقاوم للماء



Système anti buée. Anti fog system. Sistema antiappannamento. Anti Beschlag System. نظام ضد الضباب



Lumière ambient. Ambient light. Luce ambiente. Ambient Light. Omgevingslicht. اضاءة خلفية



Capteurs de contact. Contact sensor On/Off. Sensore di con tatto On/Off. Sensorschalter On/Off. Aanraken Schakelaar. حساس لمس اطفاء / تشغيل



Réversible. It is reversible. Reversibile. Umkehrbar. Omkeerbaar. ja استعمال عكسي

# sigma.80

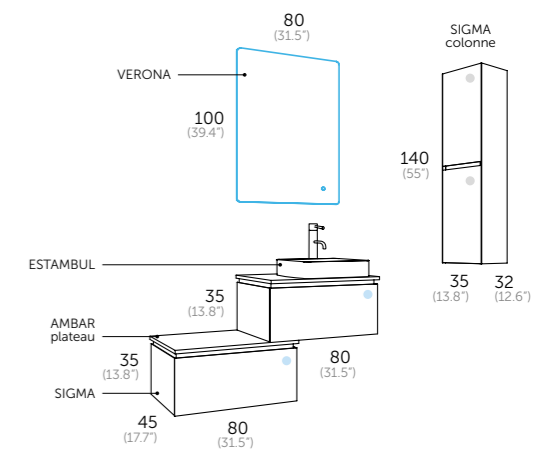

## Composition | blanc mat

2	190 27 080	<b>Sigma 80</b>
2	508 01 080	<b>Ambar plateau</b>
1	507 01 005	<b>Estambul</b>
1	246 00 100	<b>Verona</b>



## Auxiliaires

1	190 27 340	<b>Colonne</b>
---	------------	----------------



Blanc mat  
Matte white  
Bianco opaco  
Weiß matt  
Mat wit  
أبيض مت



Chêne naturel  
Natural oak  
Rovere naturale  
Natureiche  
Naturel eiken  
بلوط طبيعي



Gris intense mat  
Matte dark grey  
Grigio intenso opaco  
Grau intensiv matt  
Intens mat grijs  
رمادي مت غامق



Résistant à l'eau.  
Resistant to water.



Résistant à l'eau.  
Resistant to water.

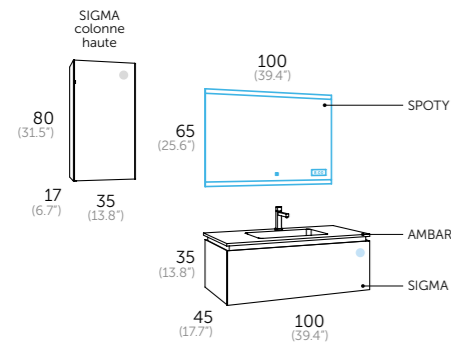

#### Composition | chêne naturel

1	190 24 100	<b>Sigma 100</b>
1	506 01 100	<b>Ambar</b>
1	267 00 100	<b>Spoty</b>

#### Auxiliaires

1	190 24 435	<b>Colonne haute</b>
---	------------	----------------------



#### Robinet

1	412 24 800	<b>Combi / chêne naturel</b>
---	------------	------------------------------

## sigma.100



Glissières métalliques. Metal interior drawers. Sistema di estrazione metallico. Metallzierleiste. Metalen zijkanten. درج معدني



Extraction e. extraction. Estrazione e. Komplet herausziehbar. Volledig uittrekbaar. لمك حرد حتف ماظن



Fermeture ralentie. Soft close. Frenata soft close. Sanfter Verschluss. Zachtsluitend. نظام إغلاق ائوماتيكي



Glissières Hettich. Hettich sliding system. Guide Hettich. Korpuschiene Hettich. Hettich lade system. مفصلات المانية هيتش



Fermeture ralentie. Soft close. Frenata soft close. Sanfter Verschluss. Zachtsluitend. نظام إغلاق ائوماتيكي



Mélamine structuré. Textured melamine. Melamina testurizzata. Textur mit Relief. Reliëfstructuur. ملمس منقوش



Résistant à l'eau. Resistant to water. Idrorepellente. Wasserfest. مقاوم للماء.



Système anti buée. Anti fog system. Sistema antiappannamento. Anti Beschlag System. نظام ضد الضباب. Spiegelverwarming



Lumière ambiant. Ambient light. Luce ambiente. Ambient Light. أضواء خلفية. Omgevingslicht



Montre digitale. Digital clock. Orologio digitale. Digitaluhr. Digitale klok. ساعة رقمية



Capteurs de contact. Contact sensor On/Off. Sensore di con tatto On/Off. Sensorschalter On/Off. Aanraken Schakelaar. حساس لمس اطفاء / تشغيل



Lecture de musique intégré, connection Bluetooth. 2 Haut-parleurs 3W chacun. Built in music player, bluetooth connection. 2 speakers of 3W each. Lettore musicale integrato, connessione a Bluetooth. 2 altoparlanti 3W ciascuno. Musik Player integriert, Bluetooth Anschluss. 2 Lautsprecher je mit 3W. Muziekspeler. 2 speakers 3W elke. مسجلة داخلية بلوتوث 2 مكتر صوت 3 واط كل واحد

## sigma.100



Glissières métalliques. Metal interior drawers. Sistema di estrazione metallico. Metallzierleiste. Metalen zijkanten. درج معدني



Extraction e. extraction. Estrazione e. Komplet herausziehbar. Volledig uittrekbaar. لمك حرد حتف ماظن



Fermeture ralentie. Soft close. Frenata soft close. Sanfter Verschluss. Zachtsluitend. نظام إغلاق ائوماتيكي



Glissières Hettich. Hettich sliding system. Guide Hettich. Korpuschiene Hettich. Hettich lade system. مفصلات المانية هيتش



Fermeture ralentie. Soft close. Frenata soft close. Sanfter Verschluss. Zachtsluitend. نظام إغلاق ائوماتيكي



Laqué mate. Matte lacquered finish. Laccato opaco. Matt lackiert. مات غامق



Résistant à l'eau. Resistant to water. Idrorepellente. Wasserfest. مقاوم للماء.



Blanc mat  
Matte white  
Bianco opaco  
Weiß matt  
Mat wit  
أبيض مات



Chêne naturel  
Natural oak  
Rovere naturale  
Naturele eiken  
بلوط طبيعي



Gris intense mat  
Matte dark grey  
Grigio intenso opaco  
Grau intensiv matt  
Intens mat grijs  
رمادي مات غامق

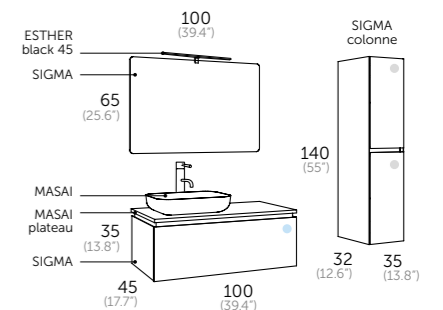

#### Composition | gris intense mat

1	190 34 100	<b>Sigma 100</b>
1	519 01 100L	<b>Masai plateau</b>
1	518 17 051	<b>Masai plomb</b>
1	290 00 100	<b>Sigma miroir</b>
1	400 02 191	<b>Esther black 45</b>

#### Auxiliaires

1	190 34 340	<b>Colonne</b>
---	------------	----------------







Résistant  
à l'eau.  
Resistant  
to water.

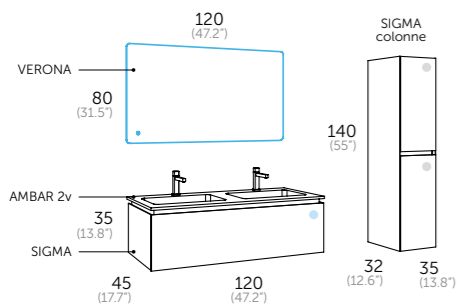

Composition | chêne naturel

1	190 24 120	<b>Sigma 120</b>
1	411 00 001	<b>Organizer optionnel</b>
1	506 01 122	<b>Ambar 2v.</b>
1	246 00 120	<b>Verona</b>

Auxiliaires

1	190 24 340	<b>Colonne</b>
---	------------	----------------



Robinet

2	412 24 800	<b>Combi / chêne naturel</b>
---	------------	------------------------------

Glissières métalliques. Metal interior drawers. Sistema di estrazione metallico. Metallzierleiste. Metalen zijkant. درج معدني

Extraction e. extraction. Estrazione e. Komplet herausziehbar. Volledig uittrekbaar. لم اناك جرد حث ف م اظن

Fermeture ralentie. Soft close. Frenata soft close. Sanfter Verschluss. Zachtsluitend. نظام إغلاق التوماتيكي

Glissières Hettich. Hettich sliding system. Guide Hettich. Korpusschiene Hettich. Hettich lade system. مفصلات الخزانة هيتش

Fermeture ralentie. Soft close. Frenata soft close. Sanfter Verschluss. Zachtsluitend. نظام إغلاق التوماتيكي

Mèlamine structuré. Textured melamine. Melamina testurizzata. Textur mit Relief. Reliefstruktur. ملمس منقوش

Résistant à l'eau. Resistant to water. Idrorepellente. Wasserfest. Waterafstotend. مقاوم للماء

Système anti buée. Anti fog system. Sistema antiappannamento. Anti Beschlag System. Spiegelverwarming. نظام ضد الضباب

Lumière ambiant. Ambient light. Luce ambiente. Ambient Light. Omgevingslicht. أضواء خلفية

Capteurs de contact. Contact sensor On/Off. Sensore di con tatto On/Off. Sensorschalter On/Off. Aanraken Schakelaar. حساس لمس اطفاء / تشغيل

Réversible. It is reversible. Reversibile. Umkehrbar. Omkeerbaar. ja استعمال عكسي

## sigma.120



Blanc mat  
Matte white  
Bianco opaco  
Weiß matt  
Mat wit  
أبيض مت



Chêne naturel  
Natural oak  
Rovere naturale  
Natureiche  
Naturel eiken  
بلوط طبيعي



Gris intense mat  
Matte dark grey  
Grigio intenso opaco  
Gruu intensiv matt  
Intens mat grijs  
رمادي مت غامق



Résistant à l'eau.  
Resistant to water.



# sigma.140

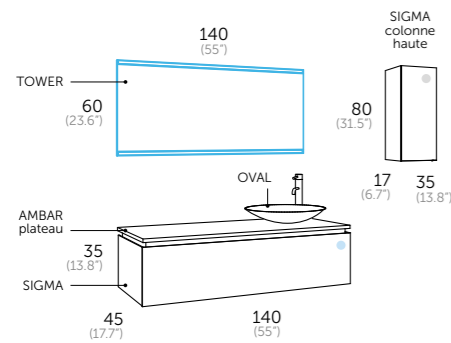

Composition | blanc mat

1	190 27 140	<b>Sigma 140</b>
1	508 01 140	<b>Ambar plateau</b>
1	509 01 001	<b>Oval</b>
1	262 00 140	<b>Tower</b>

Auxiliaires

1	190 27 435	<b>Colonne haute</b>
---	------------	----------------------



- Glissières métalliques. Metal interior drawers. Sistema di estrazione metallico. Metallzierleiste. Metalen zijkanten. درج معدني
- Extraction e. extraction. Estrazione e. Komplet herausziehbar. Volledig uittrekbaar. لم ااك جرد حتف ماظن
- Fermeture ralentie. Soft close. Frenata soft close. Sanfter Verschluss. Zachtsluitend. نظام إغلاق التوماتيكي
- Glissières Hettich. Hettich sliding system. Guide Hettich. Korpuschiene Hettich. Hettich lade system. مفصلات الجانبيهتيش
- Fermeture ralentie. Soft close. Frenata soft close. Sanfter Verschluss. Zachtsluitend. نظام إغلاق التوماتيكي
- Laquéé mate. Matte lacquered finish. Laccato opaco. Matt lackiert. Mat gelakt. مت لكر
- Résistant à l'eau. Resistant to water. Idrorepellente. Wasserfest. Waterafstotend. مقاوم للماء
- Système anti buée. Anti fog system. Sistema antiappannamento. Anti Beschlag System. نظام ضد الضباب
- Réversible. It is reversible. Reversibile. Umkehrbar. Omkeerbaar. ja. استعمال عكسي
- Capteurs de infrarouge. Infrared sensor On/Off. Sensore infrarosso On/Off. Infrarot Sensorschalter On/Off. Infrarood sensor. حساس بلونوت انطاء / تشغيل



Blanc mat  
Matte white  
Bianco opaco  
Weiß matt  
Mat wit  
أبيض مت

Chêne naturel  
Natural oak  
Rovere naturale  
Natureiche  
Naturel eiken  
بلوط طبيعي

Gris intense mat  
Matte dark grey  
Grigio intenso opaco  
Grau intensiv matt  
Intens mat grijs  
رمادي مت غامق



**sigma.80** (31.49")

plan vasque / washbasin / lavabo / waschtisch / wastafels / تروس

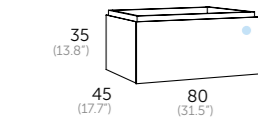

Finition	Référence
○ Blanc mat	190 27 080
● Gris intense mat	190 34 080
● Chêne naturel	190 24 080

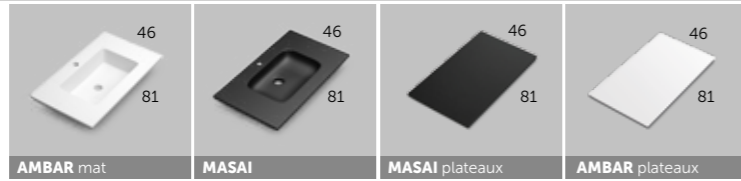

AMBAR mat	MASAI	MASAI plateaux	AMBAR plateaux
Référence 506 01 080	Référence ○ Blanc 518 01 080 ● Noir 518 02 080	Référence ○ Blanc 519 01 080 ● Noir 519 02 080	Référence 508 01 080

Plus de couleurs à la page 284 Plus de couleurs à la page 286

**sigma.100** (39.37")

plan vasque / washbasin / lavabo / waschtisch / wastafels / تروس

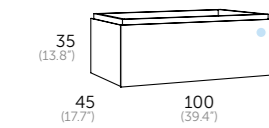

Finition	Référence
○ Blanc mat	190 27 100
● Gris intense mat	190 34 100
● Chêne naturel	190 24 100

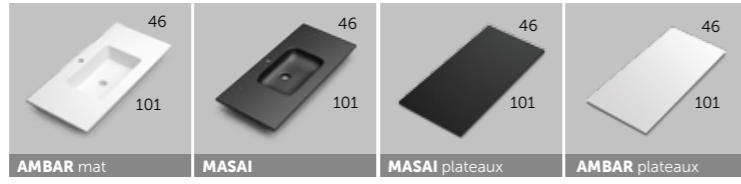

AMBAR mat	MASAI	MASAI plateaux	AMBAR plateaux
Référence 506 01 100	Référence ○ Blanc 518 01 100 ● Noir 518 02 100	Référence ○ Blanc 519 01 100 ● Noir 519 02 100	Référence 508 01 100

Plus de couleurs à la page 284 Plus de couleurs à la page 286

**sigma.120** (47.24")

plan vasque / washbasin / lavabo / waschtisch / wastafels / تروس

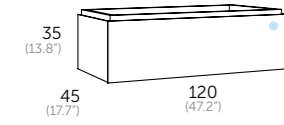

Finition	Référence
○ Blanc mat	190 27 120
● Gris intense mat	190 34 120
● Chêne naturel	190 24 120

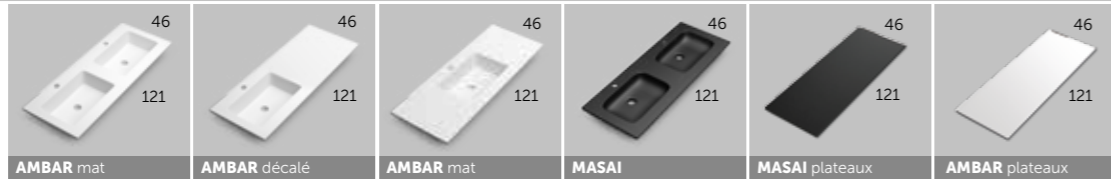

AMBAR mat	AMBAR décalé	AMBAR mat	MASAI	MASAI plateaux	AMBAR plateaux
Référence 506 01 122	Référence Gauche 506 01 121 Droite 506 01 123	Référence 506 01 120	○ Blanc 518 01 122 ● Noir 518 02 122	○ Blanc 519 01 120 ● Noir 519 02 120	Référence 508 01 120

Plus de couleurs à la page 284 Plus de couleurs à la page 286

**sigma.140** (55.1")

plan vasque / washbasin / lavabo / waschtisch / wastafels / تروس

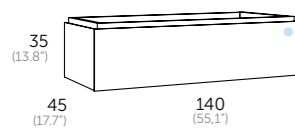

Finition	Référence
○ Blanc mat	190 27 140
● Gris intense mat	190 34 140
● Chêne naturel	190 24 140



AMBAR mat	AMBAR décalé	MASAI	MASAI plateaux	AMBAR plateaux
506 01 142	Référence Gauche 506 01 143 Droite 506 01 144	○ Blanc 518 01 142 ● Noir 518 02 142	○ Blanc 519 01 140 ● Noir 519 02 140	Référence 508 01 140

Plus de couleurs à la page 284 Plus de couleurs à la page 286

vasque à poser / over countertop basins



**La bonde**

Comprend valve CLIC CLAC universelle. INCLUS.

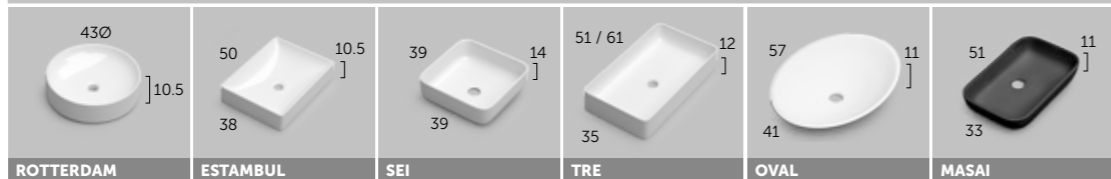

ROTTERDAM	ESTAMBUL	SEI	TRE	OVAL	MASAI
Référence 507 01 004	Référence 507 01 005	Référence 530 01 006	Référence 51 / 61 51 530 01 035 61 530 01 036	Référence 509 01 001	○ Blanc 518 01 051 ● Noir 518 02 051

Plus de couleurs à la page 289

miroirs / mirrors / specchio / spiegel / spiegels / مرآة

PLAN VASQUES ET MIROIRS PLUS D'OPTIONS DANS LES PAGES 280 - 299



SUN	SIGMA	VERONA led	VERONA rond led	TOWER led	COSMOS led	SPOTY led	SKYLINE 80
Référence 204 00 080	Référence 290 00 080	Référence 246 00 100	Référence 247 00 080	Référence 262 00 080	Référence 270 00 080	Référence 267 00 080	Référence ○ Blanc mat 341 35 080 ● Chêne naturel 341 24 080

Plus de couleurs à la page 298

miroirs / mirrors / specchio / spiegel / spiegels / مرآة



SUN	SIGMA	VERONA led	VERONA rond led	TOWER led	COSMOS led	SPOTY led	SKYLINE 100
Référence 204 00 100	Référence 290 00 100	Référence 246 00 100	Référence 247 00 100	Référence 262 00 100	Référence 270 00 100	Référence 267 00 100	Référence ○ Blanc mat 341 35 100 ● Chêne naturel 341 24 100

Plus de couleurs à la page 298

miroirs / mirrors / specchio / spiegel / spiegels / مرآة

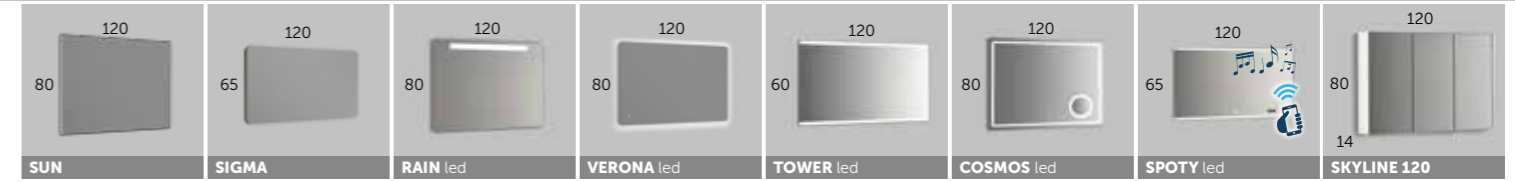

SUN	SIGMA	RAIN led	VERONA led	TOWER led	COSMOS led	SPOTY led	SKYLINE 120
Référence 204 00 120	Référence 290 00 120	Référence 269 00 120	Référence 246 00 120	Référence 262 00 120	Référence 270 00 120	Référence 267 00 120	Référence ○ Blanc mat 341 35 120 ● Chêne naturel 341 24 120

Plus de couleurs à la page 298

auxiliaires / auxiliary units

**sigma.colonne**

Finition	Référence
○ Blanc mat	190 27 340
● Gris intense mat	190 34 340
● Chêne naturel	190 24 340

Ouverture réversible | Reversible opening

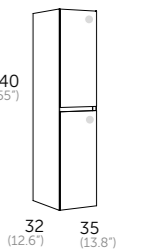

● Chrome  
412 00 800  
Plus de couleurs à la page 291

**sigma.colonne haute**

Finition	Référence
○ Blanc mat	190 27 435
● Gris intense mat	190 34 435
● Chêne naturel	190 24 435

Ouverture réversible | Reversible opening

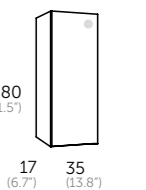

éclairage / spotlights



ESTHER 30	SOFIA 60	AINHOA 74	NIKITA	NAYRA BLANC
Référence Lumière froide 6000k 400 00 121	Référence Lumière froide 6000k 400 00 141	Référence Lumière froide 6000k 400 00 151	Référence Lumière froide 5700k 400 01 171	Référence Lumière froide 5700k 400 00 181

**sigma.organizer**

411 00 001

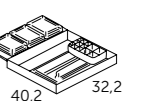

Résistant à l'eau.  
Resistant to water.



# omega.

60 / 80 / 100 / 120

- brillant / glossy
- mat / matte



Résistant à l'eau.  
Resistant to water.



# omega.60

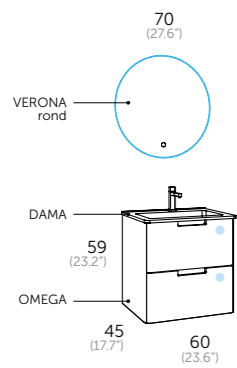

### Composition | blanc brillant

1	193 01 060	<b>Omega 60</b>
1	503 01 060	<b>Dama</b>
1	247 00 070	<b>Verona rond</b>



### Robinet

1	412 00 800	<b>Combi chrome</b>
---	------------	---------------------

- Glissières métalliques. Metal interior drawers. Sistema di estrazione metallico. Metallzierleiste. Metalen zijkanten. درج معدني
- Extraction e. extraction. Estrazione e. Komplet herausziehbar. Volledig uittrekbaar. لهماك جرد حتف ماظن
- Fermeture ralentie. Soft close. Frenata soft close. Sanfter Verschluss. Zachtsluitend. نظام إغلاق التوماتيكي
- Organisateur. Organizer unit. Organizzatore. Obere Ablage. Superieure organizer. منظم درج علوي
- Glissières Hettich. Hettich sliding system. Guide Hettich. Korpussschiene Hettich. Hettich lade system. مفصلات الجانبيههتش
- Laquée brillante. Glossy lacquered finish. Laccato lucido. Glanzend lackiert. Hoogglans gelakt. لكر ميخ لكر
- Résistant à l'eau. Resistant to water. Idrorepellente. Wasserfest. مقاوم للماء
- Système anti buée. Anti fog system. Sistema antiappannamento. Anti Beschlag System. نظام ضد الضباب
- Lumière ambient. Ambient light. Luce ambiente. Ambient Light. اضاءة خلفية
- Capteurs de contact. Contact sensor. On/Off. Sensore di con tatto On/Off. Sensorschalter On/Off. Aanraken Schakelaar. حساس لمس اطفاء / تشغيل

### brillant / glossy

- Blanc brillant  
Glossy white  
Bianco lucido  
Weiss hochglanz  
Witte glans  
ابيض ميخ لكر
- Beige gris brillant  
Glossy Mink  
Tortora lucido  
Graubeige hochglanz  
Nerts glans  
مينك لكر
- Gris brillant  
Glossy grey  
Grigio lucido  
Grau hochglanz  
Grjjs glans  
رمادي ميخ لكر

### mat / matte

- Blanc mat  
Matte white  
Bianco opaco  
Weiß matt  
Mat wit  
ابيض مت
- Beige gris mat  
Matte Mink  
Tortora opaco  
Graubeige matt  
Nerts mat  
مينك مت
- Gris intense mat  
Matte dark grey  
Grigio intenso opaco  
Grau intensiv matt  
Intens mat grijs  
رمادي مت غامق

avec plan vasque masai couleur ocean.



Résistant à l'eau.  
Resistant to water.



# omega.80



- Glissières métalliques. Metal interior drawers. Sistema di estrazione metallico. Metallzierleiste. Metalen zijkanten. درج معدني
- Extraction e. extraction. Estrazione e. Komplet herausziehbar. Volledig uittrekbaar. لپاک جرد جتف ماظن
- Fermeture ralentie. Soft close. Frenata soft close. Sanfter Verschluss. Zachtsluitend. نظام إغلاق اتوماتيكي
- Organisateur. Organizer unit. Organizzatore. Obere Ablage. Superieure organizer. منظم درج علوي
- Glissières Hettich. Hettich sliding system. Guide Hettich. Korpuschiene Hettich. Hettich lade system. مفصلات الجالايه هيتش
- Fermeture ralentie. Soft close. Frenata soft close. Sanfter Verschluss. Zachtsluitend. نظام إغلاق اتوماتيكي
- Laquéé brillant. Glossy lacquered finish. Laccato lucido. Glänzend lackiert. Hoogglans gelakt. لكر لميع
- Résistant à l'eau. Resistant to water. Idrorepellente. Wasserfest. Waterafstotend. مقاوم للماء
- Système anti buée. Anti fog system. Sistema antiappannamento. Anti Beschlag System. نظام ضد الضباب
- Capteurs de contact. Contact sensor On/Off. Sensore di con tatto On/Off. Sensorschalter On/Off. Aanraken Schakelaar. حساس لمس انقطاع / تشغيل
- Mirior loupe 3x éclairé. Magnifying zoom in Mirror. Lente d'ingrandimento 3x. Lupe 3x Vergrößerung. Vergrootglas: verhoging x 3. مكبرمراية 3 اضعاف

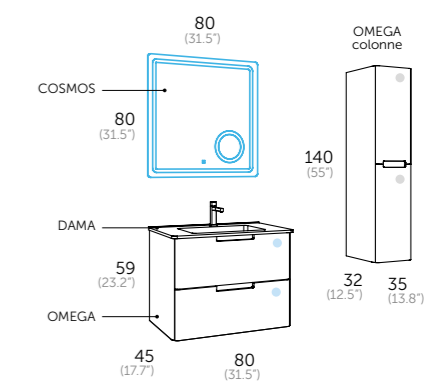

Composition | beige gris brillant

1	193 16 080	<b>Omega 80</b>
1	503 01 080	<b>Dama</b>
1	270 00 080	<b>Cosmos</b>

Auxiliaires

1	193 16 335	<b>Colonne</b>
---	------------	----------------

Robinet

1	412 00 800	<b>Combi chrome</b>
---	------------	---------------------

brillant / glossy

- Blanc brillant  
Glossy white  
Bianco lucido  
Weiss hochglanz  
Witte glans  
أبيض لميع لكر
- Beige gris brillant  
Glossy Mink  
Tortora lucido  
Graubeige hochglanz  
Nerts glans  
مينك لكر
- Gris brillant  
Glossy grey  
Grigio lucido  
Gru hochglanz  
Nerts glans  
رمادي لميع لكر

mat / matte

- Blanc mat  
Matte white  
Bianco opaco  
Weiß matt  
Mat wit  
أبيض مت
- Beige gris mat  
Matte Mink  
Tortora opaco  
Graubeige matt  
Nerts mat  
مينك مت
- Gris intense mat  
Matte dark grey  
Grigio intenso opaco  
Gru intensiv matt  
Intens mat grijs  
رمادي مت غامق



Résistant à l'eau.  
Resistant to water.



Résistant à l'eau.  
Resistant to water.



# omega.100

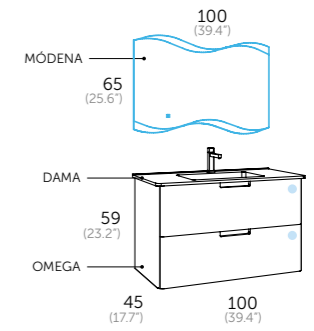

Composition | beige gris mat

1	193 46 100	<b>Omega 100</b>
1	503 01 100	<b>Dama</b>
1	264 00 100	<b>Módena</b>

- Glissières métalliques. Metal interior drawers. Sistema di estrazione metallico. Metallzierleiste. Metalen zijkanten. درج معدني
- Extraction e. extraction. Estrazione e. Komplet herausziehbar. Volledig uittrekbaar. لم ايك جرد حتف ماظن
- Fermeture ralentie. Soft close. Frenata soft close. Sanfter Verschluss. Zachtsluitend. نظام إغلاق ائوماتيكي
- Organisateur. Organizer unit. Organizzatore. Obere Ablage. Superieure organizer. منظم درج علوي
- Glissières Hettich. Hettich sliding system. Guide Hettich. Korpusschiene Hettich. Hettich lade system. مفصلات المائية هتيتش
- Laquéé mate. Matte lacquered finish. Laccato opaco. Matt lackiert. مات غلاكت. لكر مت
- Résistant à l'eau. Resistant to water. Idrorepellente. Wasserfest. Waterafstotend. مقاوم للماء
- Système anti buée. Anti fog system. Sistema antiappannamento. Anti Beschlag System. Spiegelverwarming. نظام ضد الضباب
- Lumière ambient. Ambient light. Luce ambiente. Ambient Light. اضاءة خلفية
- Capteurs de contact. Contact sensor On/Off. Sensore di con tatto On/Off. Sensorschalter On/Off. Aanraken Schakelaar. حساسي لمس اطفاء / تشغيل
- Réversible. It is reversible. Reversibile. Umkehrbar. Omkeerbaar; ja استعمال عكسي

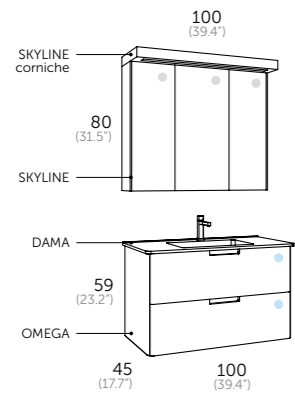

Composition | gris brillant

1	193 03 100	<b>Omega 100</b>
1	503 01 100	<b>Dama</b>
1	341 03 100	<b>Skyline</b>
1	341 03 101	<b>Corniche</b>



Robinet

1	412 00 800	<b>Combi chrome</b>
---	------------	---------------------

- Glissières métalliques. Metal interior drawers. Sistema di estrazione metallico. Metallzierleiste. Metalen zijkanten. درج معدني
- Extraction e. extraction. Estrazione e. Komplet herausziehbar. Volledig uittrekbaar. لم ايك جرد حتف ماظن
- Fermeture ralentie. Soft close. Frenata soft close. Sanfter Verschluss. Zachtsluitend. نظام إغلاق ائوماتيكي
- Organisateur. Organizer unit. Organizzatore. Obere Ablage. Superieure organizer. منظم درج علوي
- Glissières Hettich. Hettich sliding system. Guide Hettich. Korpusschiene Hettich. Hettich lade system. مفصلات المائية هتيتش
- Fermeture ralentie. Soft close. Frenata soft close. Sanfter Verschluss. Zachtsluitend. نظام إغلاق ائوماتيكي
- Laquéé brillant. Glossy lacquered finish. Laccato lucido. Glanzend lackiert. Hoogglans gelakt. لكر ميغ
- Résistant à l'eau. Resistant to water. Idrorepellente. Wasserfest. Waterafstotend. مقاوم للماء

brillant / glossy

- Blanc brillant  
Glossy white  
Bianco lucido  
Weiss hochglanz  
Witte glans  
أبيض ميغ لكر
- Beige gris brillant  
Glossy Mink  
Tortora lucido  
Graubeige hochglanz  
Nerts glans  
مينك لكر
- Gris brillant  
Glossy grey  
Grigio lucido  
Grau hochglanz  
Grjys glans  
رمادي ميغ لكر

mat / matte

- Blanc mat  
Matte white  
Bianco opaco  
Weiß matt  
Mat wit  
أبيض مت
- Beige gris mat  
Matte Mink  
Tortora opaco  
Graubeige matt  
Nerts mat  
مينك مت
- Gris intense mat  
Matte dark grey  
Grigio intenso opaco  
Grau intensiv matt  
Intens mat grijs  
رمادي مت غامق

Résistant à l'eau.  
Resistant to water.



# omega.120

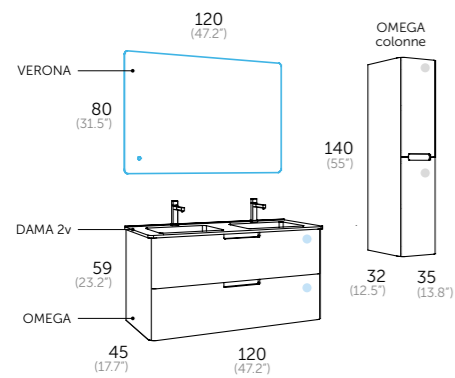

### Composition | blanc mat

1	193 27 120	<b>Omega 120</b>
1	503 01 122	<b>Dama 2v.</b>
1	246 00 120	<b>Verona</b>

### Auxiliaires

1	193 27 335	<b>Colonne</b>
---	------------	----------------



### Robinet

2	412 00 800	<b>Combi chrome</b>
---	------------	---------------------

- Glissières métalliques. Metal interior drawers. Sistema di estrazione metallico. Metallzierleiste. Metalen zijkanten. درج معدني
- Extraction e. extraction. Estrazione e. Komplett herausziehbar. Volledig uittrekbaar. لمداد جرد حاتف ماظن
- Fermeture ralentie. Soft close. Frenata soft close. Sanfter Verschluss. Zachtsluitend. نظام إغلاق التوماتيكي
- Organisateur. Organizer unit. Organizzatore. Obere Ablage. Superieure organizer. منظم درج علوي
- Glissières Hettich. Hettich sliding system. Guide Hettich. Körperschiene Hettich. Hettich lade system. مفصلات الهيكلية
- Fermeture ralentie. Soft close. Frenata soft close. Sanfter Verschluss. Zachtsluitend. نظام إغلاق التوماتيكي
- Laquéé brillant. Glossy lacquered finish. Laccato lucido. Glänzend lackiert. Hoogglans gelakt. لكر ليح
- Résistant à l'eau. Resistant to water. Idrorepellente. Wasserfest. Waterafstotend. مقاوم للماء
- Système anti buée. Anti fog system. Sistema antiappannamento. Anti Beschlag System. نظام ضد الضباب
- Lumière ambiant. Ambient light. Luce ambiente. Ambient Light. Omgevingslicht. أضادة خلفية
- Capteurs de contact. Contact sensor. On/Off. Sensore di con tatto On/Off. Sensorschalter On/Off. Aanraken Schakelaar. حساس لمس اطفاء / تشغيل
- Réversible. It is reversible. Reversibile. Umkehrbar. Omkeerbaar. ja استعمال عكسي



### brillant / glossy



Blanc brillant  
Glossy white  
Bianco lucido  
Weiss hochglanz  
Witte glans  
أبيض ليح لكر



Beige gris brillant  
Glossy Mink  
Tortora lucido  
Graubeige hochglanz  
Nerts glans  
مينك لكر



Gris brillant  
Glossy grey  
Grigio lucido  
Gru hochglanz  
Grjns glanz  
رمادي ليح لكر

### mat / matte



Blanc mat  
Matte white  
Bianco opaco  
Weiß matt  
Mat wit  
أبيض مت



Beige gris mat  
Matte Mink  
Tortora opaco  
Graubeige matt  
Nerts mat  
مينك مت



Gris intense mat  
Matte dark grey  
Grigio intenso opaco  
Gru intensiv matt  
Intens mat grijs  
رمادي مت غامق



omega.60 (23.62")

plan vasque / washbasin / lavabo / waschtisch / wastafels / تروس

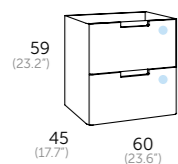

- Blanc brillant 193 01 060
- Gris brillant 193 03 060
- Beige gris brillant 193 16 060
- Blanc mat 193 27 060
- Gris intense mat 193 34 060
- Beige gris mat 193 46 060

<b>DAMA</b> céramique	<b>MASAI</b> angles arrondis
Référence 503 01 060	Référence ○ Blanc 518 01 060 C ● Noir 518 02 060 C Plus de couleurs à la page 284

miroirs / mirrors / specchio / spiegel / spiegels / مرآيا

PLAN VASQUES ET MIROIRS PLUS D'OPTIONS DANS LES PAGES 280 - 299

<b>SUN</b>	<b>ROND</b>	<b>RAIN</b> led	<b>VERONA</b> led	<b>VERONA</b> rond led	<b>MÓDENA</b> led	<b>FLASH 60</b>	<b>SKYLINE 60</b>
Référence 204 00 060	Référence 244 00 060	Référence 269 00 060	Référence 246 00 060	Référence 247 00 070	Référence 264 00 080	Référence Aluminium 340 11 060	Référence ○ Blanc brillant 341 01 060 ● Beige gris mat 341 46 060 Plus de couleurs à la page 298

omega.80 (31.49")

plan vasque / washbasin / lavabo / waschtisch / wastafels / تروس

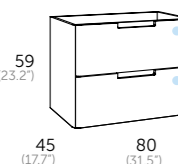

- Blanc brillant 193 01 080
- Gris brillant 193 03 080
- Beige gris brillant 193 16 080
- Blanc mat 193 27 080
- Gris intense mat 193 34 080
- Beige gris mat 193 46 080

<b>DAMA</b> céramique	<b>MASAI</b> angles arrondis
Référence 503 01 080	Référence ○ Blanc 518 01 080 C ● Noir 518 02 080 C Plus de couleurs à la page 284

miroirs / mirrors / specchio / spiegel / spiegels / مرآيا

<b>SUN</b>	<b>SIGMA</b>	<b>VERONA</b> led	<b>VERONA</b> rond led	<b>TOWER</b> led	<b>COSMOS</b> led	<b>SPOTY</b> led	<b>SKYLINE 80</b>
Référence 204 00 080	Référence 290 00 080	Référence 246 00 100	Référence 247 00 080	Référence 262 00 080	Référence 270 00 080	Référence 267 00 080	Référence ○ Blanc brillant 341 01 080 ● Beige gris mat 341 46 080 Plus de couleurs à la page 298

omega.100 (39.37")

plan vasque / washbasin / lavabo / waschtisch / wastafels / تروس

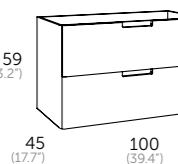

- Blanc brillant 193 01 100
- Gris brillant 193 03 100
- Beige gris brillant 193 16 100
- Blanc mat 193 27 100
- Gris intense mat 193 34 100
- Beige gris mat 193 46 100

<b>DAMA</b> céramique	<b>MASAI</b> angles arrondis
Référence 503 01 100	Référence ○ Blanc 518 01 100 C ● Noir 518 02 100 C Plus de couleurs à la page 284

miroirs / mirrors / specchio / spiegel / spiegels / مرآيا

<b>SUN</b>	<b>SIGMA</b>	<b>VERONA</b> led	<b>VERONA</b> rond led	<b>TOWER</b> led	<b>COSMOS</b> led	<b>SPOTY</b> led	<b>SKYLINE 100</b>
Référence 204 00 100	Référence 290 00 100	Référence 246 00 100	Référence 247 00 100	Référence 262 00 100	Référence 270 00 100	Référence 267 00 100	Référence ○ Blanc brillant 341 01 100 ● Beige gris mat 341 46 100 Plus de couleurs à la page 298

omega.120 (47.24")

plan vasque / washbasin / lavabo / waschtisch / wastafels / تروس

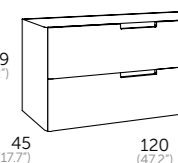

- Blanc brillant 193 01 120
- Gris brillant 193 03 120
- Beige gris brillant 193 16 120
- Blanc mat 193 27 120
- Gris intense mat 193 34 120
- Beige gris mat 193 46 120

<b>DAMA</b> céramique	<b>DAMA</b>	<b>MASAI</b> angles arrondis	<b>MASAI</b> angles arrondis
Référence 503 01 120	Référence 503 01 122	Référence ○ Blanc 518 01 120 C ● Noir 518 02 120 C Plus de couleurs à la page 284	Référence ○ Blanc 518 01 122 C ● Noir 518 02 122 C Plus de couleurs à la page 284

miroirs / mirrors / specchio / spiegel / spiegels / مرآيا

<b>SUN</b>	<b>RAIN</b> led	<b>VERONA</b> led	<b>COSMOS</b> led	<b>SKYLINE 120</b>
Référence 204 00 120	Référence 269 00 120	Référence 246 00 120	Référence 270 00 120	Référence ○ Blanc brillant 341 01 120 ● Beige gris mat 341 46 120 Plus de couleurs à la page 298

auxiliaires / auxiliary units

omega.colonne

- Blanc brillant 193 01 335
- Gris brillant 193 03 335
- Beige gris brillant 193 16 335
- Blanc mat 193 27 335
- Gris intense mat 193 34 335
- Beige gris mat 193 46 335

Ouverture réversible | Reversible opening

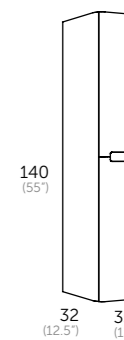

éclairage / spotlights

<b>NEREA MAT</b>	<b>ESTHER 30</b>	<b>SOFIA 60</b>	<b>AINHOA 74</b>	<b>NIKITA</b>	<b>NAYRA BLANC</b>
Référence Lumière froide 6000k 400 14 161	Référence Lumière froide 6000k 400 00 121	Référence Lumière froide 6000k 400 00 141	Référence Lumière froide 6000k 400 00 151	Référence Lumière froide 5700k 400 01 171	Référence Lumière froide 5700k 400 00 181

pieds / legs

<b>Kit Industrial</b> (Réversible)	<b>Pieds KUADRO</b>
Pour meuble 59 cm hauteur ● Noir 412 02 710 135	Pour meuble 59 cm hauteur ● Noir 412 02 720 ● Aluminium 412 00 720

<b>UNIV. CLIC CLAC</b> Valve	<b>COMBI</b> Robinet
● Chrome 410 00 203 Plus de couleurs à la page 330	● Chrome 412 00 800 Plus de couleurs à la page 291





**berlín.**

60 / 70 / 80 / 100







- Blanc mat  
Matte white  
Bianco opaco  
Weiß matt  
Mat wit  
أبيض مت
- Chêne naturel  
Natural oak  
Rovere naturale  
Natureiche  
Naturel eiken  
بلوط طبيعي
- Pin gris  
Grey pine  
Pino-grigio  
Kiefer grau  
Grijs pijn  
سرو رمادي
- Wenge nature  
بني غامق طبيعي



- 

Glissières métalliques. Metal interior drawers. Sistema di estrazione metallico. Metallzierleiste. Metalen zijkanten. درج معدني
- 

Extraction e. extraction. Estrazione e. Komplet herausziehbar. Volledig uittrekbaar. لமாக چرد جتف ماظن
- 

Fermeture ralentie. Soft close. Frenata soft close. Sanfter Verschluss. Zachtsluitend. نظام إغلاق أوماتيكي
- 

Organisateur. Organizer unit. Organizzatore. Obere Ablage. Superieure organizer. منظم درج علوي
- 

Glissières Hettich. Hettich sliding system. Guide Hettich. Korpuschiene Hettich. Hettich lade system. مفصلات الماينة هيتش
- 

Laquéé mate. Matte lacquered finish. Laccato opaco. Matt lackiert. Mat gelakt. لكر مت
- 

Système anti buée. Anti fog system. Sistema antiappannamento. Anti Beschlag System. نظام ضد الضباب
- 

Lumière ambient. Ambient light. Luce ambiente. Ambient Light. اضاءة خلفية
- 

Capturs de contact. Contact sensor On/Off. Sensore di con tatto On/Off. Sensorschalter On/Off. Aanraken Schakelaar. حساس لمس انطاء / تشغيل
- 

Réversible. It is reversible. Reversibile. Umkehrbar. Omkeerbaar. ja استعمال عكسي

## berlín.60

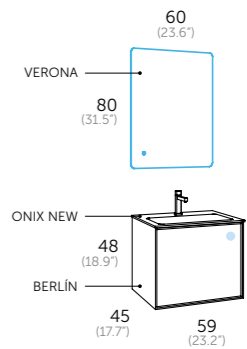

Composition | blanc mat

1	143 27 060	<b>Berlín 60</b>
1	550 01 060	<b>Onix new</b>
1	246 00 060	<b>Verona</b>

Robinet

1	412 00 800	<b>Combi chrome</b>
---	------------	---------------------



-  Glissières métalliques. Metal interior drawers. Sistema di estrazione metallico. Metallzierleiste. Metalen zijkanten. درج معدني
-  Extraction e. extraction. Estrazione e. Komplet herausziehbar. Volledig uittrekbaar. لمحرك جرد حترف ماطن
-  Fermeture ralentie. Soft close. Frenata soft close. Sanfter Verschluss. Zachtsluitend. نظام إغلاق انوماتيكي
-  Organisateur. Organizer unit. Organizzatore. Obere Ablage. Superieure organizer. منظم درج علوي
-  Glissières Hettich. Hettich sliding system. Guide Hettich. Korpuschiene Hettich. Hettich lade system. مفصلات امانية هيتش
-  Fermeture ralentie. Soft close. Frenata soft close. Sanfter Verschluss. Zachtsluitend. نظام إغلاق انوماتيكي
-  Mélamine structuré. Textured melamine. Melamina testurizzata. Textur mit Relief. Reliëfstructuur. ملمس منقوش
-  Système anti bueé. Anti fog system. Sistema antiappannamento. Anti Beschlag System. نظام ضد الضباب
-  Lumière ambient. Ambient light. Luce ambiente. Ambient Light. اضاءة خلفية
-  Montre digitale. Digital clock. Orologio digitale. Digitaluhr. Digitale klok. ساعة رقمية
-  Capteurs de contact. Contact sensor On/Off. Sensore di con tatto On/Off. Sensorschalter On/Off. Aanraken Schakelaar. حساس لمس انفتاح / تشغيل
-  Lecteur de musique intégré, connection Bluetooth. 2 Haut-parleurs 3W chacun. Built in music player, bluetooth connection. 2 speakers of 3W each. Lettore musicale integrato, connessione a Bluetooth. 2 altoparlanti 3W ciascuno. Musik Player integriert, Bluetooth Anschluss. 2 Lautsprecher je mit 3W. Muziekspeler. 2 speakers 3W elke. مسجلة داخلية. بلوتوث 2 مكبر صوت 3 وات كل واحد

# berlín.80

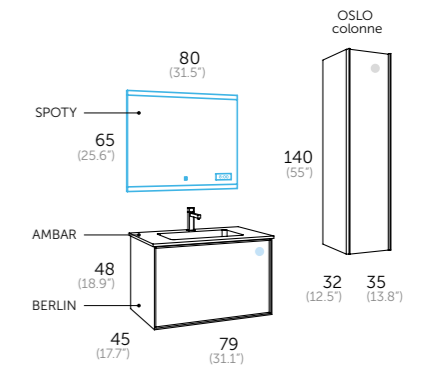

## Composition | pin gris

1	143 37 080	<b>Berlín 80</b>
1	506 01 080	<b>Ambar</b>
1	267 00 080	<b>Spoty</b>

## Auxiliaires

1	142 37 335	<b>Oslo colonne</b>
---	------------	---------------------

## Robinet

1	412 00 800	<b>Combi chrome</b>
---	------------	---------------------

-  Blanc mat  
Matte white  
Bianco opaco  
Weiß matt  
Mat wit  
أبيض مت
-  Chêne naturel  
Natural oak  
Rovere naturale  
Natureiche  
Naturele eiken  
بلوط طبيعي
-  Pin gris  
Grey pine  
Pino-grigio  
Kiefer grau  
Grijs pijn  
سرو رمادي
-  Wenge naturel  
بني غامق طبيعي



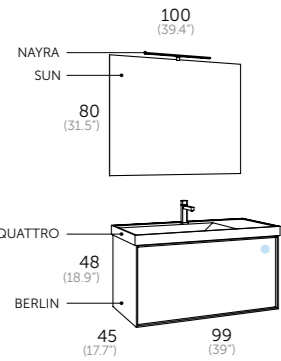

Composition | wenge nature

1	143 44 100	<b>Berlín 100</b>
1	521 01 100	<b>Quattro</b>
1	204 00 100	<b>Sun</b>
1	400 00 181	<b>Nayra</b>

Robinet

1	412 00 800	<b>Combi chrome</b>
---	------------	---------------------

# berlín.100

- Glissières métalliques. Metal interior drawers. Sistema di estrazione metallico. Metallzierleiste. Metalen zijkanten. درج معدني
- Extraction e. extraction. Estrazione e. Komplet herausziehbar. Volledig uittrekbaar. لهماك جرد حاتف م اظان
- Fermeture ralentie. Soft close. Frenata soft dose. Sanfter Verschluss. Zachtsluitend. نظام إغلاق انومانيكي
- Organisateur. Organizer unit. Organizzatore. Obere Ablage. Superieure organizer. منظم درج علوي
- Glissières Hettich. Hettich sliding system. Guide Hettich. Korpusschiene Hettich. Hettich lade system. مفصلات الماينة هيتش
- Melamine structuré. Textured melamine. Melamina testurizzata. Textur mit Relief. Reliefstructuur. ملمس منقوش

- Blanc mat  
Matte white  
Bianco opaco  
Weiß matt  
Mat wit  
أبيض مت
- Chêne naturel  
Natural oak  
Rovere naturale  
Natureiche  
Naturele eiken  
بلوط طبيعي
- Pin gris  
Grey pine  
Pino-grigio  
Kiefer grau  
Grijs pijn  
سرو رمادي
- Wenge nature  
بني غامق طبيعي



# berlín.120

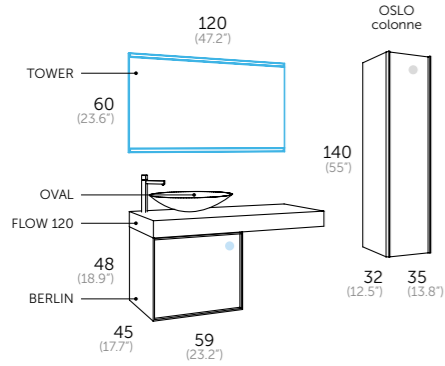

## Composition | chêne naturel

1	143 24 060	<b>Berlín 60</b>
1	138 24 120	<b>Flow 120 f46</b>
1	509 01 001	<b>Oval</b>
1	262 00 120	<b>Tower</b>

## Auxiliaires

1	142 24 335	<b>Oslo colonne</b>
---	------------	---------------------



Blanc mat Matte white Bianco opaco Weiß matt Mat wit أبيض مت	Chêne naturel Natural oak Rovere naturale Natureiche Naturel eiken بلوط طبيعي	Pin gris Grey pine Pino-grigio Kiefer grau Grijs pijn سرو رمادي	Wenge nature بني غامق طبيعي

- Glissières métalliques. Metal interior drawers. Sistema di estrazione metallico. Metallzierleiste. Metalen zijkanten. درج معدني
- Extraction e. extraction. Estrazione e. Komplet herausziehbar. Volledig uittrekbaar. لمكك جرد حتف ماظن
- Fermeture ralentie. Soft close. Frenata soft close. Sanfter Verschluss. Zachtsluitend. نظام إغلاق أوتوماتيكي
- Organisateur. Organizer unit. Organizzatore. Obere Ablage. Superieure organizer. منظم درج علوي
- Glissières Hettich. Hettich sliding system. Guide Hettich. Korpuschiene Hettich. Hettich lade system. مفصلات المانعةهتيش
- Fermeture ralentie. Soft close. Frenata soft close. Sanfter Verschluss. Zachtsluitend. نظام إغلاق أوتوماتيكي
- Melamine structuré. Textured melamine. Melamina testurizzata. Textur mit Relief. Reliefstructuur. ملمس منقوش
- Système anti buée. Anti fog system. Sistema antiappannamento. Anti Beschlag System. Spiegelverwarming. نظام ضد الضباب
- Réversible. It is reversible. Reversibile. Umkehrbar. Omkeerbaar. ja. استعمال عكسي
- Capteurs de infrarouge. Infrared sensor On/Off. Sensore infrarosso On/Off. Infrarot Sensorschalter On/Off. Infrarood sensor. حساس بلوتوث انfrared / تشغيل





## berlin.60 (23.62")

plan vasque / washbasin / lavabo / waschtisch / wastafels / تروس

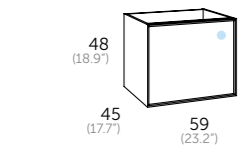

Finition	Référence
○ Blanc mat	143 27 060
● Chêne naturel	143 24 060
● Pin gris	143 37 060
● Wenge nature	143 44 060



ONIX NEW céramique	TOPACIO résine	QUATTRO céramique	AMBAR mat	MASAI	MASAI plateaux
Référence 550 01 060	Référence 505 01 060	Référence 521 01 060	Référence 506 01 060	Référence ○ Blanc 518 01 060 ● Noir 518 02 060	Référence ○ Blanc 519 01 060 ● Noir 519 02 060

Plus de couleurs à la page 284 Plus de couleurs à la page 286

miroirs / mirrors / specchio / spiegel / spiegels / مرآيا

PLAN VASQUES ET MIROIRS PLUS D'OPTIONS DANS LES PAGES 280 - 299



SUN	ROND	RAIN led	VERONA led	VERONA rond led	MÓDENA led	FLASH 60	SKYLINE 60
Référence 204 00 060	Référence 244 00 060	Référence 269 00 060	Référence 246 00 060	Référence 247 00 070	Référence 264 00 080	Référence Aluminium 340 11 060	Référence ○ Blanc mat 341 35 060 ● Chêne naturel 341 24 060

## berlin.70 (27.5")

plan vasque / washbasin / lavabo / waschtisch / wastafels / تروس

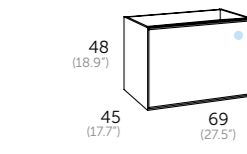

Finition	Référence
○ Blanc mat	143 27 070
● Chêne naturel	143 24 070
● Pin gris	143 37 070
● Wenge nature	143 44 070



ONIX NEW céramique	AMBAR mat	MASAI	MASAI plateaux	AMBAR plateaux
Référence 550 01 070	Référence 506 01 070	Référence ○ Blanc 518 01 070 ● Noir 518 02 070	Référence ○ Blanc 519 01 070 ● Noir 519 02 070	Référence 508 01 070

Plus de couleurs à la page 284 Plus de couleurs à la page 286

miroirs / mirrors / specchio / spiegel / spiegels / مرآيا

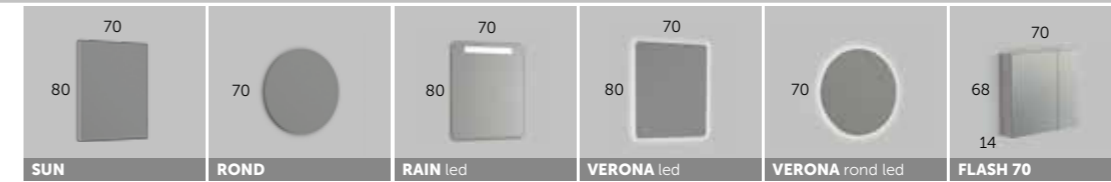

SUN	ROND	RAIN led	VERONA led	VERONA rond led	FLASH 70
Référence 204 00 070	Référence 244 00 070	Référence 269 00 070	Référence 246 00 070	Référence 247 00 070	Référence Aluminium 340 11 070

## berlin.80 (31.49")

plan vasque / washbasin / lavabo / waschtisch / wastafels / تروس

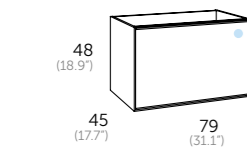

Finition	Référence
○ Blanc mat	143 27 080
● Chêne naturel	143 24 080
● Pin gris	143 37 080
● Wenge nature	143 44 080



ONIX NEW céramique	TOPACIO résine	QUATTRO céramique	AMBAR mat	MASAI	MASAI plateaux
Référence 550 01 080	Référence 505 01 080	Référence 521 01 080	Référence 506 01 080	Référence ○ Blanc 518 01 080 ● Noir 518 02 080	Référence ○ Blanc 519 01 080 ● Noir 519 02 080

Plus de couleurs à la page 284 Plus de couleurs à la page 286

miroirs / mirrors / specchio / spiegel / spiegels / مرآيا



SUN	SIGMA	VERONA led	VERONA rond led	TOWER led	COSMOS led	SPOTY led	SKYLINE 80
Référence 204 00 080	Référence 290 00 080	Référence 246 00 100	Référence 247 00 080	Référence 262 00 080	Référence 270 00 080	Référence 267 00 080	Référence ○ Blanc mat 341 35 080 ● Chêne naturel 341 24 080

## berlin.100 (39.37")

plan vasque / washbasin / lavabo / waschtisch / wastafels / تروس

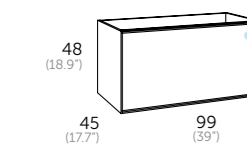

Finition	Référence
○ Blanc mat	143 27 100
● Chêne naturel	143 24 100
● Pin gris	143 37 100
● Wenge nature	143 44 100

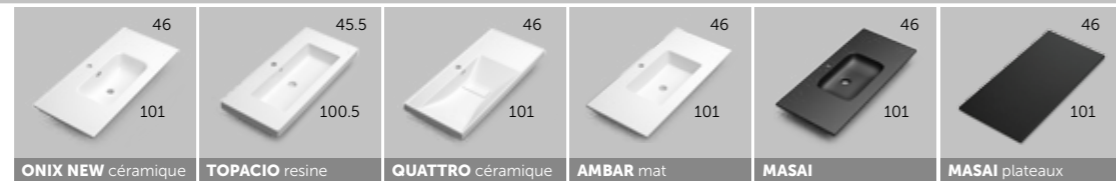

ONIX NEW céramique	TOPACIO résine	QUATTRO céramique	AMBAR mat	MASAI	MASAI plateaux
Référence 550 01 100	Référence 505 01 100	Référence 521 01 100	Référence 506 01 100	Référence ○ Blanc 518 01 100 ● Noir 518 02 100	Référence ○ Blanc 519 01 100 ● Noir 519 02 100

Plus de couleurs à la page 284 Plus de couleurs à la page 286

miroirs / mirrors / specchio / spiegel / spiegels / مرآيا



SUN	VERONA led	VERONA rond led	TOWER led	SKYLINE 100
Référence 204 00 100	Référence 246 00 100	Référence 247 00 100	Référence 262 00 100	Référence ○ Blanc mat 341 35 100 ● Chêne naturel 341 24 100

auxiliaires / auxiliary units

### oslo.colonne

○ Blanc mat	142 27 335
● Chêne naturel	142 24 335
● Pin gris	142 37 335
● Wenge nature	142 44 335

Ouverture réversible | Reversible opening

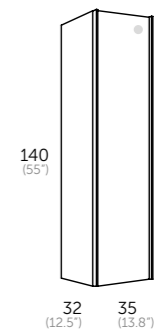

## landes.plateaux

avec barre de renfort en aluminium

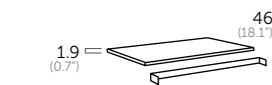

	Chêne naturel	Pin Gris
60	112 24 206	112 37 206
70	112 24 207	112 37 207
80	112 24 208	112 37 208
100	112 24 210	112 37 210

## flow. profondeur 46 cm



	Chêne naturel	Pin Gris
60	138 24 060	138 37 060
70	138 24 070	138 37 070
80	138 24 080	138 37 080
100	138 24 100	138 37 100
120	138 24 120	138 37 120
140	138 24 140	138 37 140

vasque à poser / over countertop basins



ROTTERDAM	ESTAMBUL	SEI
Référence 507 01 004	Référence 507 01 005	Référence 530 01 006

pieds / legs

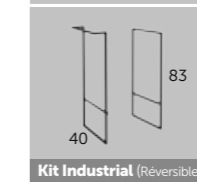

Kit Industrial (Réversible)  
Pour meuble 48 cm hauteur

● Noir	412 02 715	135
--------	------------	-----



# lúxor.

80 / 100





# lúxor.80

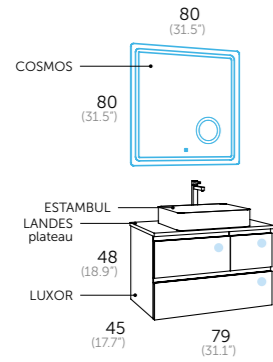

## Composition | pin gris

1	196 37 080	<b>Lúxor 80</b>
1	112 37 208	<b>Landes plateau</b>
1	507 01 005	<b>Estambul</b>
1	270 00 080	<b>Cosmos</b>



-  Glissières métalliques. Metal interior drawers. Sistema di estrazione metallico. Metallzierleiste. Metalen zijkanten. درج معدني
-  Extraction e. extraction. Estrazione e. Komplet herausziehbar. Volledig uittrekbaar. لم ااك جرد حتف ام اطن
-  Fermeture ralentie. Soft close. Frenata soft dose. Sanfter Verschluss. Zachtsluitend. نظام إغلاق انوماتيكي
-  Organisateur. Organizer unit. Organizzatore. Obere Ablage. Superieure organizer. منظم درج علوي
-  Glissières Hettich. Hettich sliding system. Guide Hettich. Korpuschiene Hettich. Hettich lade system. مفصلات الماينة هيتش
-  Mélamine structuré. Textured melamine. Melamina testurizzata. Textur mit Relief. Reliefstructuur. ملمس منقوش
-  Système anti buée. Anti fog system. Sistema antiappannamento. Anti Beschlag System. نظام ضد الضباب
-  Capteurs de contact. Contact sensor On/Off. Sensore di con tatto On/Off. Sensorschalter On/Off. Aanraken Schakelaar. حساس لمس اطفاء / تشغيل
-  Miroir loupe 3x éclairé. Magnifying zoom in Mirror. Lente d'ingrandimento 3x. Lupe 3x Vergrößerung. Vergrootglas: verhoging x3. مكبرمراية 3 أضواء



-  Blanc brillant  
Glossy white  
Bianco lucido  
Weiss hochglanz  
أبيض لميع لكر
-  Chêne naturel  
Natural oak  
Rovere naturale  
Naturliche  
Naturele eiken  
بلوط طبيعي
-  Pin gris  
Grey pine  
Pino-grigio  
Kiefer grau  
Grijs pijn  
سرو رومادي
-  Noyer  
Dark walnut  
Noce  
Walnuss  
Walnoot  
خشبي جوي



# lúxor.80

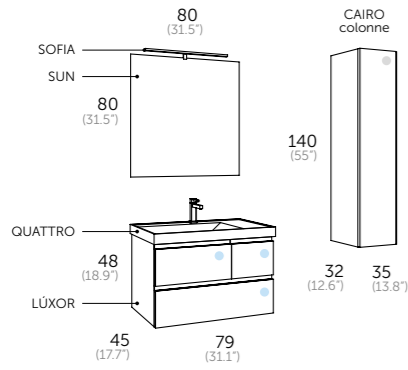

## Composition | noyer

1	196 39 080	Lúxor 80
1	521 01 080	Quattro
1	204 00 080	Sun
1	400 00 141	Sofia

## Auxiliaires

1	194 39 335	Cairo colonne
---	------------	---------------



## Robinet

1	412 00 800	Combi chrome
---	------------	--------------

- Glissières métalliques. Metal interior drawers. Sistema di estrazione metallico. Metallzierleiste. Metalen zijanten. درج معدني
- Extraction e. extraction. Estrazione e. Komplet herausziehbar. Volledig uittrekbaar. لهماك جرد حتف ماظن
- Fermeture ralentie. Soft close. Frenata soft close. Sanfter Verschluss. Zachtsluitend. نظام إغلاق اتوماتيكي
- Organisateur. Organizer unit. Organizzatore. Obere Ablage. Superieure organizer. منظم درج علوي
- Glissières Hettich. Hettich sliding system. Guide Hettich. Korpussschiene Hettich. Hettich lade system. مفصلات الماوية هيتش
- Fermeture ralentie. Soft close. Frenata soft close. Sanfter Verschluss. Zachtsluitend. نظام إغلاق اتوماتيكي
- Mélangé structuré. Textured melamine. Melamina testurizzata. Textur mit Relief. Reliefstructuur. ملمس منشوش



# lúxor.100

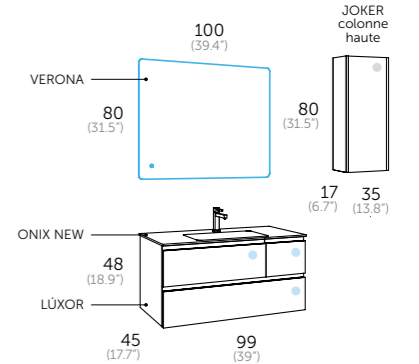

## Composition | blanc brillant

1	196 01 100	Lúxor 100
1	550 01 100	Onix new
1	246 00 100	Verona

## Auxiliaires

1	137 01 435	Joker colonne haute
---	------------	---------------------



## Robinet

1	412 00 800	Combi chrome
---	------------	--------------

- Système anti bue. Anti fog system. Sistema antiappannamento. Anti Beschlag System. Spiegelerwarming. نظام ضد الضباب
- Lumière ambient. Ambient light. Luce ambiente. Ambient Light. Omgevingslicht. اضاءة خلفية
- Capteurs de contact. Contact sensor On/Off. Sensore di con tatto On/Off. Sensorschalter On/Off. Aanraken Schakelaar. حساس لمس اطفاء / تشغيل
- Réversible. It is reversible. Reversibile. Umkehrbar. Omkeerbaar; ja استعمال عكسي

- Blanc brillant  
Glossy white  
Bianco lucido  
Weiss hochglanz  
Witte glans  
أبيض لمع لكر
- Chêne naturel  
Natural oak  
Rovere naturale  
Naturele eiken  
بلوط طبيعي
- Pin gris  
Grey pine  
Pino-grigio  
Kiefer grau  
Grijs pijn  
سرو رمادي
- Noyer  
Dark walnut  
Noce  
Walnuss  
Walnoot  
خشبي جوزي

- Glissières métalliques. Metal interior drawers. Sistema di estrazione metallico. Metallzierleiste. Metalen zijanten. درج معدني
- Extraction e. extraction. Estrazione e. Komplet herausziehbar. Volledig uittrekbaar. لهماك جرد حتف ماظن
- Fermeture ralentie. Soft close. Frenata soft close. Sanfter Verschluss. Zachtsluitend. نظام إغلاق اتوماتيكي
- Organisateur. Organizer unit. Organizzatore. Obere Ablage. Superieure organizer. منظم درج علوي
- Glissières Hettich. Hettich sliding system. Guide Hettich. Korpussschiene Hettich. Hettich lade system. مفصلات الماوية هيتش
- Fermeture ralentie. Soft close. Frenata soft close. Sanfter Verschluss. Zachtsluitend. نظام إغلاق اتوماتيكي
- Laqué brillant. Glossy lacquered finish. Laccato lucido. Glanzend lackiert. Hoogglans gelakt. لكر لمع





Blanc brillant  
Glossy white  
Bianco lucido  
Weiss hochglanz  
Witte glans  
أبيض لميع لكر



Chêne naturel  
Natural oak  
Rovere naturale  
Natureiche  
Naturele eiken  
بلوط طبيعي



Pin gris  
Grey pine  
Pino-grigio  
Kiefer grau  
Grijs pijn  
سرو رمادي



Noyer  
Dark walnut  
Noce  
Walnuss  
Walnoot  
خشبي جوزي



Glissières métalliques. Metal interior drawers. Sistema di estrazione metallico. Metallzieleiste. Metalen zijkanten.  
درج معدني



Extraction e. extraction. Estrazione e. Komplet hierausziehbar. Volledig uittrekbaar.  
لماك جرد حتف ماظن



Fermeture ralentie. Soft close. Frenata soft close. Sanfter Verschluss. Zachtsluitend.  
نظام إغلاق اتوماتيكي



Organisateur. Organizer unit. Organizzatore. Obere Ablage. Superieure organizer.  
منظم درج علوي



Glissières Hettich. Hettich sliding system. Guide Hettich. Korpuschiene Hettich. Hettich lade system.  
مفصلات الجانية هيتش



Fermeture ralentie. Soft close. Frenata soft close. Sanfter Verschluss. Zachtsluitend.  
نظام إغلاق اتوماتيكي



Mélamine structuré. Textured melamine. Melamina testurizzata. Textur mit Relief. Reliëfstructuur.  
ملمس منقوش



Système anti buée. Anti fog system. Sistema antiappannamento. Anti Beschlag System.  
نظام خذ الضباب



Lumière ambiante. Ambient light. Luce ambiente. Ambient Light. Omgevingslicht.  
إضاءة خلفية



Montre digitale. Digital clock. Orologio digitale. Digitaluhr. Digitale klok.  
ساعة رقمية



Capteurs de contact. Contact sensor On/Off. Sensore di con tatto On/Off. Sensorschalter On/Off. Aanraken Schakelaar.  
حساس لمس اطفاء / تشغيل



Lecteur de musique intégré, connexion Bluetooth. 2 Haut-parleurs 3W chacun. Built in music player, bluetooth connection. 2 speakers of 3W each. Lettore musicale integrato, connessione a Bluetooth. 2 altoparlanti 3W ciascuno. Musik Player integriert, Bluetooth Anschluss. 2 Lautsprecher je mit 3W. Muziekspeler. 2 speakers 3W elke.  
مسجلة داخلية بلوتوث 2 مكبر صوت 3 واط كل واحد

# lúxor.100

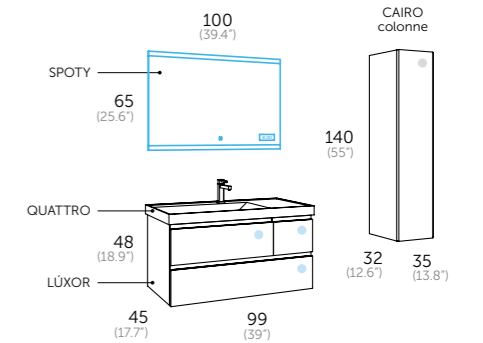

## Composition | chêne naturel

1	196 24 100	<b>Lúxor 100</b>
1	550 01 100	<b>Onix new</b>
1	267 00 100	<b>Spoty</b>

## Auxiliaires

1	194 24 335	<b>Cairo colonne</b>
---	------------	----------------------



## Robinet

1	412 00 800	<b>Combi chrome</b>
---	------------	---------------------

## lúxor.80 (31.49")

plan vasque / washbasin / lavabo / waschtisch / wastafels / تروس

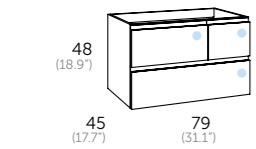

Finition	Référence
○ Blanc brillant	196 01 080
● Chêne naturel	196 24 080
● Pin gris	196 37 080
● Noyer	196 39 080



ONIX NEW céramique	TOPACIO résine	QUATTRO céramique	AMBAR mat	MASAI	MASAI plateau
Référence 550 01 080	Référence 505 01 080	Référence 521 01 080	Référence 506 01 080	Référence ○ Blanc 518 01 080 ● Noir 518 02 080	Référence ○ Blanc 519 01 080 ● Noir 519 02 080

Plus de couleurs à la page 284 Plus de couleurs à la page 286

## lúxor.100 (39.37")

plan vasque / washbasin / lavabo / waschtisch / wastafels / تروس

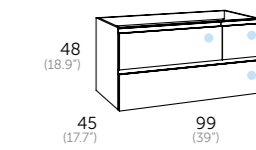

Finition	Référence
○ Blanc brillant	196 01 100
● Chêne naturel	196 24 100
● Pin gris	196 37 100
● Noyer	196 39 100



ONIX NEW céramique	TOPACIO résine	QUATTRO céramique	AMBAR mat	MASAI	MASAI plateau
Référence 550 01 100	Référence 505 01 100	Référence 521 01 100	Référence 506 01 100	Référence ○ Blanc 518 01 100 ● Noir 518 02 100	Référence ○ Blanc 519 01 100 ● Noir 519 02 100

Plus de couleurs à la page 284 Plus de couleurs à la page 286

## landes.plateaux

avec barre de renfort en aluminium

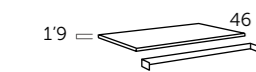

	Chêne naturel	Pin Gris
80	112 24 208	112 37 208
100	112 24 210	112 37 210

vasque à poser / over countertop basins

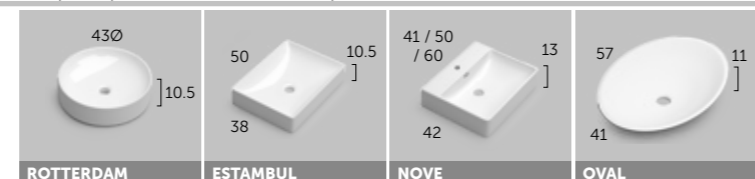

ROTTERDAM	ESTAMBUL	NOVE	OVAL
Référence 507 01 004	Référence 507 01 005	Référence 41 530 01 094 50 530 01 095 60 530 01 096	Référence 509 01 001

## auxiliaires / auxiliary units

### cairo.colonne

Finition	Référence
○ Blanc brillant	194 01 335
● Chêne naturel	194 24 335
● Pin gris	194 37 335
● Noyer	194 39 335

Ouverture réversible | Reversible opening

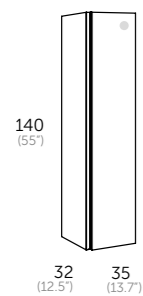

### joker.colonne haute

Finition	Référence
○ Blanc brillant	137 01 435
● Chêne naturel	137 24 435
● Pin gris	137 37 435
● Noyer	137 39 435

Ouverture réversible | Reversible opening

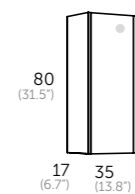

### joker.auxiliaire

Finition	Référence
○ Blanc brillant	137 01 445
● Chêne naturel	137 24 445
● Pin gris	137 37 445
● Noyer	137 39 445

Ouverture réversible | Reversible opening

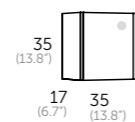

pieds / legs

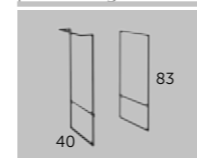

Kit Industrial (Réversible)
Pour meuble 48 cm hauteur
● Noir 412 02 715
135

miroirs / mirrors / specchio / spiegel / spiegels / مرآيا

PLAN VASQUES ET MIROIRS PLUS D'OPTIONS DANS LES PAGES 280 - 299



SUN	SIGMA	VERONA led	VERONA rond led	TOWER led	COSMOS led	SPOTY led	SKYLINE 80
Référence 204 00 080	Référence 290 00 080	Référence 246 00 100	Référence 247 00 080	Référence 262 00 080	Référence 270 00 080	Référence 267 00 080	Référence ○ Blanc brillant 341 01 080 ● Chêne naturel 341 24 080 ● Aluminium 341 11 080

miroirs / mirrors / specchio / spiegel / spiegels / مرآيا



SUN	SIGMA	VERONA led	VERONA rond led	COSMOS led	TOWER led	SPOTY led	SKYLINE 100
Référence 204 00 100	Référence 290 00 100	Référence 246 00 100	Référence 247 00 100	Référence 270 00 100	Référence 262 00 100	Référence 267 00 100	Référence ○ Blanc brillant 341 01 100 ● Chêne naturel 341 24 100 ● Aluminium 341 11 100

éclairage / spotlights



EVA	NEREA MAT	ESTHER 30	ESTHER BLACK 30	SOFIA 60	AINHOA 74	NIKITA	NAYRA BLANC
Référence Lumière froide 4000k 400 00 011	Référence Lumière froide 6000k 400 14 161	Référence Lumière froide 6000k 400 00 121	Référence Lumière froide 6000k 400 02 121	Référence Lumière froide 6000k 400 00 141	Référence Lumière froide 6000k 400 00 151	Référence Lumière froide 5700k 400 01 171	Référence Lumière froide 5700k 400 00 181



UNIV. CLIC CLAC Valve	COMBI Robinet
● Chrome 410 00 203	● Chrome 412 00 800
Plus de couleurs à la page 330	Plus de couleurs à la page 291

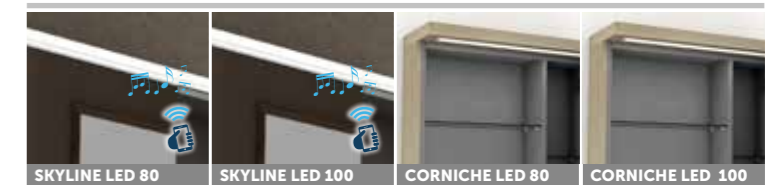

SKYLINE LED 80	SKYLINE LED 100	CORNICHE LED 80	CORNICHE LED 100
Référence 400 00 521	Référence 400 00 531	Référence ○ Blanc brillant 341 01 081 ● Chêne naturel 341 24 081 ● Aluminium 341 11 081	Référence ○ Blanc brillant 341 01 101 ● Chêne naturel 341 24 101 ● Aluminium 341 11 101



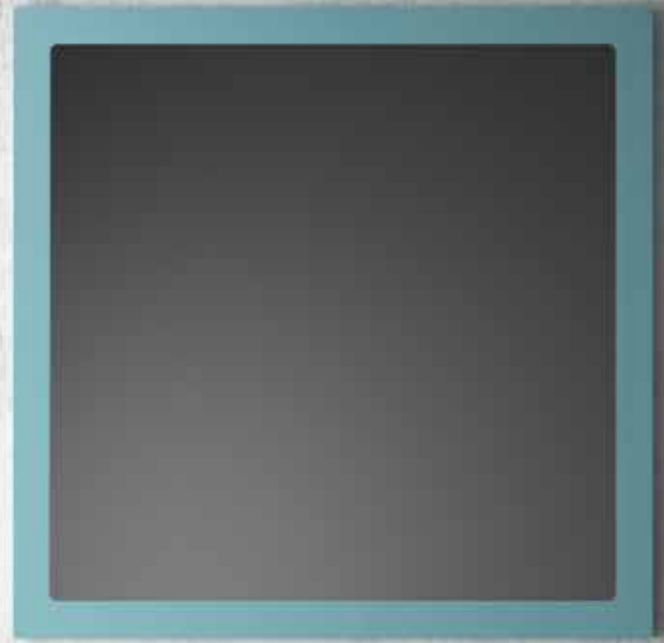

**toscana.**

60 / 80 / 100



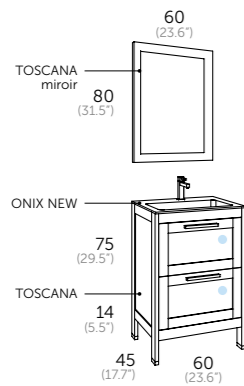

Composition | deep blue

- 1 197 18 060 **Toscana 60**
- 1 550 01 060 **Onix new**
- 1 296 18 060 **Toscana miroir**



Robinet

- 1 412 00 800 **Combi chrome**

## toscana.60

- Glissières métalliques. Metal interior drawers. Sistema di estrazione metallico. Metallzierleiste. Metalen zijkanten. درج معدني
- Extraction e. extraction. Estrazione e. Komplet herausziehbar. Volledig uittrekbaar. لهماك جرد حتف ماظن
- Fermeture ralentie. Soft close. Frenata soft close. Sanfter Verschluss. Zachtsluitend. نظام إغلاق أوماتيكي
- Organisateur. Organizer unit. Organizzatore. Obere Ablage. Superieure organizer. منظم درج علوي
- Glissières Hettich. Hettich sliding system. Guide Hettich. Korpuschiene Hettich. Hettich lade system. مفصلات المانية هيتش
- Laquéé mate. Matte lacquered finish. Laccato opaco. Matt lackiert. Mat gelakt. مت لكر

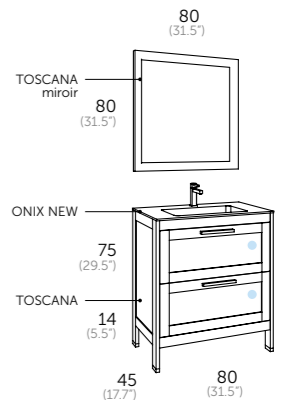

## toscana.80

- Glissières métalliques. Metal interior drawers. Sistema di estrazione metallico. Metallzierleiste. Metalen zijkanten. درج معدني
- Extraction e. extraction. Estrazione e. Komplet herausziehbar. Volledig uittrekbaar. لهماك جرد حتف ماظن
- Fermeture ralentie. Soft close. Frenata soft close. Sanfter Verschluss. Zachtsluitend. نظام إغلاق أوماتيكي
- Organisateur. Organizer unit. Organizzatore. Obere Ablage. Superieure organizer. منظم درج علوي
- Glissières Hettich. Hettich sliding system. Guide Hettich. Korpuschiene Hettich. Hettich lade system. مفصلات المانية هيتش
- Laquéé mate. Matte lacquered finish. Laccato opaco. Matt lackiert. Mat gelakt. مت لكر

Composition | blanc mat

- 1 197 27 080 **Toscana 80**
- 1 550 01 080 **Onix new**
- 1 296 27 080 **Toscana miroir**



Robinet

- 1 412 00 800 **Combi chrome**

- Blanc mat  
Matte white  
Bianco opaco  
Weiß matt  
Mat wit  
أبيض مت
- Chêne naturel  
Natural oak  
Rovere naturale  
Naturele eiken  
بلوط طبيعي
- Pin gris  
Grey pine  
Pino-grigio  
Kiefer grau  
Grijs pijn  
سرو رمادي
- Deep blue  
ازرق غامق





- Blanc mat  
Matte white  
Bianco opaco  
Weiß matt  
Mat wit  
أبيض مت
- Chêne naturel  
Natural oak  
Rovere naturale  
Naturliche  
Naturel eiken  
بلوط طبيعي
- Pin gris  
Grey pine  
Pino-grigio  
Kiefer grau  
Grijs pijn  
سرو رمادي
- Deep blue  
ازرق غامق

# toscana.80



- 

Glissières métalliques. Metal interior drawers. Sistema di estrazione metallico. Metallzierleiste. Metalen zijkanten.  
درج معدني
- 

Extraction e. extraction. Estrazione e. Komplet herausziehbar. Volledig uittrekbaar.  
لمك جرد جت ف ماظن
- 

Fermeture ralentie. Soft close. Frenata soft close. Sanfter Verschluss. Zachtsluitend.  
نظام إغلاق أوماتيكي
- 

Glissières Hettich. Hettich sliding system. Guide Hettich. Korpussschiene Hettich. Hettich lade system.  
مفصلات لمانية هيتش
- 

Organisateur. Organizer unit. Organizzatore. Obere Ablage. Superieure organizer.  
منظم درج علوي
- 

Fermeture ralentie. Soft close. Frenata soft close. Sanfter Verschluss. Zachtsluitend.  
نظام إغلاق أوماتيكي
- 

Mélamine structurée. Textured melamine. Melamina testurizzata. Textur mit Relief. Reliefstructuur.  
ملمس منقوش

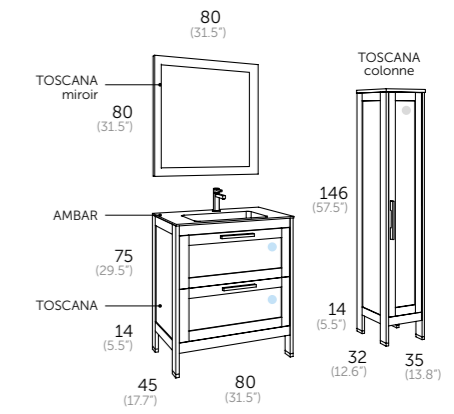

**Composition | chêne naturel**

1	197 24 080	<b>Toscana 80</b>
1	506 01 080	<b>Ambar 80</b>
1	296 24 080	<b>Toscana miroir</b>

**Auxiliaires**

1	197 24 335	<b>Colonne</b>
---	------------	----------------

**Robinet**

1	412 00 800	<b>Combi chrome</b>
---	------------	---------------------



# toscana.100

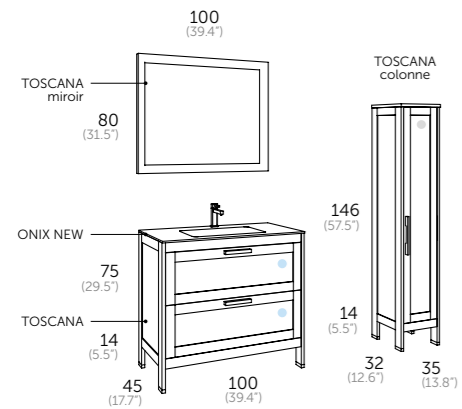

## Composition | pin gris

1	197 37 100	<b>Toscana 100</b>
1	550 01 100	<b>Onix new</b>
1	296 37 100	<b>Toscana miroir</b>

## Auxiliaires

1	197 37 335	<b>Colonne</b>
---	------------	----------------

## Robinet

1	412 00 800	<b>Combi chrome</b>
---	------------	---------------------

Blanc mat Matte white Bianco opaco Weiß matt Mat wit أبيض مت	Chêne naturel Natural oak Rovere naturale Naturele eiken بلوط طبيعي	Pin gris Grey pine Pino-grigio Kiefer grau Grijs pijn سرو رمادي	Deep blue ازرق غامق

- Glissières métalliques. Metal interior drawers. Sistema di estrazione metallico. Metallzierleiste. Metalen zijkanen. درج معدني
- Extraction e. extraction. Estrazione e. Komplet herausziehbar. Volledig uittrekbaar. لهماك جرد حتف ماظن
- Fermeture ralentie. Soft close. Frenata soft close. Sanfter Verschluss. Zachtsluitend. نظام إغلاق أومائي. منظم
- Glissières Hettich. Hettich sliding system. Guide Hettich. Korpuschiene Hettich. Hettich lade system. مفصلات الجانبة هيتش
- Organisateur. Organizer unit. Organizzatore. Obere Ablage. Superieure organizer. منظم درج علوي
- Fermeture ralentie. Soft close. Frenata soft close. Sanfter Verschluss. Zachtsluitend. نظام إغلاق أومائي. منظم
- Melamine structuré. Textured melamine. Melamina testurizzata. Textur mit Relief. ملمس منقوش





**toscana.60** (23.62")

plan vasque / washbasin / lavabo / waschtisch / wastafels / تروس

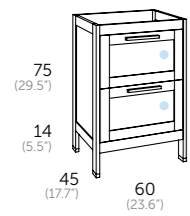

Finition	Référence
○ Blanc mat	197 27 060
● Deep blue mat	197 18 060
● Chêne naturel	197 24 060
● Pin gris	197 37 060



ONIX NEW	TOPACIO	QUATTRO	AMBAR	MASAI	MASAI plateaux
46 x 61	45.5 x 60.5	46 x 61	46 x 61	46 x 61	46 x 61
550 01 060	505 01 060	521 01 060	506 01 060	518 01 060 / 518 02 060	519 01 060 / 519 02 060

Plus de couleurs à la page 284 Plus de couleurs à la page 286

PLAN VASQUES ET MIROIRS PLUS D'OPTIONS DANS LES PAGES 280 - 299

miroirs / mirrors / specchio / spiegel / spiegels / مرايا



TOSCANA	SUN	ROND	RAIN	VERONA	VERONA rond	SKYLINE 60
60 x 80	60 x 80	60	60 x 80	60 x 80	70	60 x 80
296 27 060	204 00 060	244 00 060	269 00 060	246 00 060	247 00 070	341 35 060 / 341 24 060 / 341 11 060

**toscana.80** (31.49")

plan vasque / washbasin / lavabo / waschtisch / wastafels / تروس

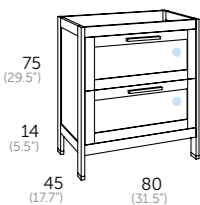

Finition	Référence
○ Blanc mat	197 27 080
● Deep blue mat	197 18 080
● Chêne naturel	197 24 080
● Pin gris	197 37 080



ONIX NEW	TOPACIO	QUATTRO	AMBAR	MASAI	MASAI plateaux
46 x 81	45.5 x 80.5	46 x 81	46 x 81	46 x 81	46 x 81
550 01 080	505 01 080	521 01 080	506 01 080	518 01 080 / 518 02 080	519 01 080 / 519 02 080

Plus de couleurs à la page 284 Plus de couleurs à la page 286

miroirs / mirrors / specchio / spiegel / spiegels / مرايا

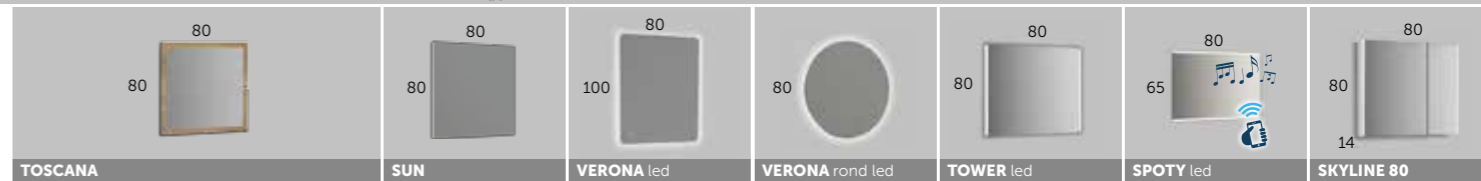

TOSCANA	SUN	VERONA	VERONA rond	TOWER	SPOTY	SKYLINE 80
80 x 80	80 x 80	80 x 100	80	80 x 80	80 x 65	80 x 80
296 37 080	204 00 080	246 00 100	247 00 080	262 00 080	267 00 080	341 35 080 / 341 24 080 / 341 11 080

**toscana.100** (39.37")

plan vasque / washbasin / lavabo / waschtisch / wastafels / تروس

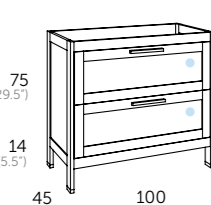

Finition	Référence
○ Blanc mat	197 27 100
● Deep blue mat	197 18 100
● Chêne naturel	197 24 100
● Pin gris	197 37 100



ONIX NEW	TOPACIO	QUATTRO	AMBAR	MASAI	MASAI plateaux
46 x 101	45.5 x 100.5	46 x 101	46 x 101	46 x 101	46 x 101
550 01 100	505 01 100	521 01 100	506 01 100	518 01 100 / 518 02 100	519 01 100 / 519 02 100

Plus de couleurs à la page 284 Plus de couleurs à la page 286

miroirs / mirrors / specchio / spiegel / spiegels / مرايا



TOSCANA	SUN	VERONA	VERONA rond	TOWER	SPOTY	SKYLINE 100
100 x 80	100 x 80	100 x 80	100	100 x 60	100 x 65	100 x 80
296 27 100	204 00 100	246 00 100	247 00 100	262 00 100	267 00 100	341 35 100 / 341 24 100 / 341 11 100

**auxiliaires / auxiliary units**

**toscana.colonne**

Finition	Référence
○ Blanc mat	197 27 335
● Deep blue mat	197 18 335
● Chêne naturel	197 24 335
● Pin gris	197 37 335

Ouverture réversible | Reversible opening

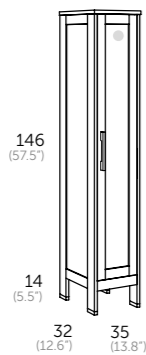

vasque à poser / over countertop basins

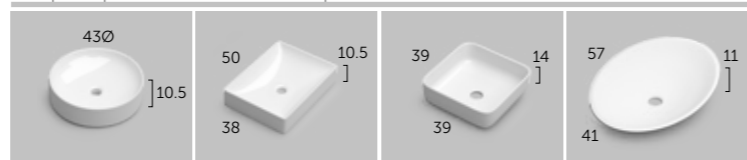

ROTTERDAM	ESTAMBUL	SEI	OVAL
43Ø x 10.5	50 x 10.5	39 x 14	57 x 11
507 01 004	507 01 005	530 01 006	509 01 001

éclairage / spotlights



NEREA MAT	ESTHER 30	ESTHER BLACK 30	SOFIA 60
400 14 161	400 00 121	400 02 121	400 00 141



UNIV. CLIC CLAC Valve	COMBI Robinet
410 00 203	412 00 800

Plus de couleurs à la page 330 Plus de couleurs à la page 291

Résistant à l'eau.  
Resistant to water.



# flow.

60 / 70 / 80 / 100 / 120 / 140



# ambar lip.

70 / 80 / 100 / 120

solid surface





Résistant à l'eau.  
Resistant to water.



Résistant à l'eau.  
Resistant to water.



# flow.60

Composition | chêne naturel

1	138 24 061	<b>Flow 60 f40</b>
1	410 00 101	<b>Siphon chrome</b>
1	530 01 002	<b>Due</b>
1	208 00 055	<b>Versa</b>

Auxiliaire

1	416 00 003	<b>Lip-porte-serviettes 40</b>
---	------------	--------------------------------

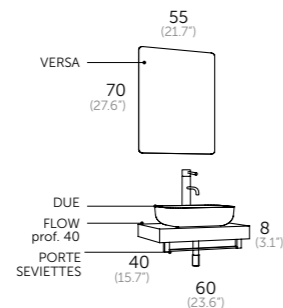

Mélamine structurée. Textured melamine.  
Melamina testurizzata. Textur mit Relief. Reliefstructuur. ملمس متقوس

Résistant à l'eau. Resistant to water.  
Idrorepellente. Wasserfest. Waterafstotend. مقاوم للماء



Chêne naturel  
Natural oak  
Rovere naturale  
Naturele eiken  
بلوط طبيعي



Pin gris  
Grey pine  
Pino-grigio  
Kiefer grau  
Grijs pijn  
سرو رمادي

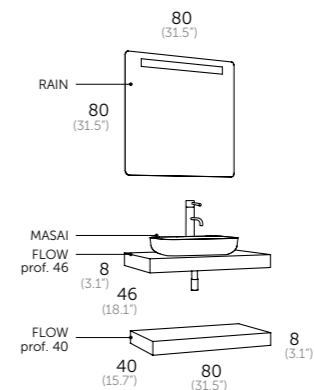

# flow.80

Composition | pin gris

1	138 37 080	<b>Flow 80 f46</b>
1	138 37 081	<b>Flow 80 f40</b>
1	410 00 101	<b>Siphon chrome</b>
1	518 01 051	<b>Masai</b>
1	269 00 080	<b>Rain</b>





# flow.100

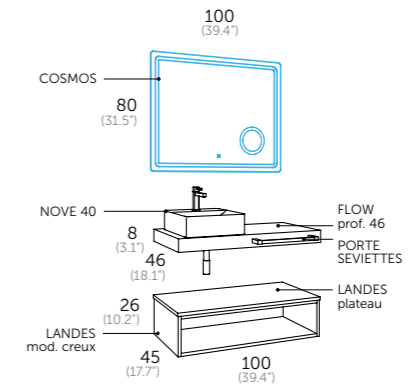

- Mélangine structurée. Textured melamine. Melamina testurizzata. Textur mit Relief. Reliefstructuur. ملمس منقوش
- Résistant à l'eau. Resistant to water. Idrorepellente. Wasserfest. Waterafstotend. مقاوم للماء
- Système anti buée. Anti fog system. Sistema antiappannamento. Anti Beschlag System. Spiegelfverwarming. نظام خذ الضباب
- Capturs de contact. Contact sensor On/Off. Sensore di con tatto On/Off. Sensorschalter On/Off. Aanraken Schakelaar. حساس لمس اظفار / تشغيل
- Miroir loupe 3x éclairé. Magnifying zoom in Mirror. Lente d'ingrandimento 3x. Lupe 3x Vergrößerung. Vergrootglas: verhoging x 3. مكبرية 3 أضعاف

Composition | chêne naturel | anthracite

1	138 24 100	<b>Flow 100 f46</b>
1	410 00 101	<b>Siphon chrome</b>
1	112 45 105	<b>Landes module creux</b>
1	112 45 210	<b>Landes plateau</b>
1	530 01 094	<b>Novo 40</b>
1	270 00 100	<b>Cosmos</b>

Auxiliaire

1	416 00 003	<b>Lip-porte-serviettes 40</b>
---	------------	--------------------------------

Robinet

1	412 00 800	<b>Combi chrome</b>
---	------------	---------------------

- Chêne naturel / Natural oak / Rovere naturale / Naturele eiken / بلوط طبيعي
- Pin gris / Grey pine / Pino-grigio / Kiefer grau / Grijs pijn / سرو رمادي



Résistant à l'eau.  
Resistant to water.



Résistant à l'eau.  
Resistant to water.



## flow.120

Composition | pin gris

1	138 37 120	<b>Flow 120 f46</b>
2	410 00 101	<b>Siphon chrome</b>
2	112 37 064	<b>Landes module tiroir</b>
1	112 37 212	<b>Landes plateau</b>
	422 00 000	<b>Poignée Line / chrome</b>
2	507 01 004	<b>Rotterdam</b>
1	246 00 120	<b>Verona</b>

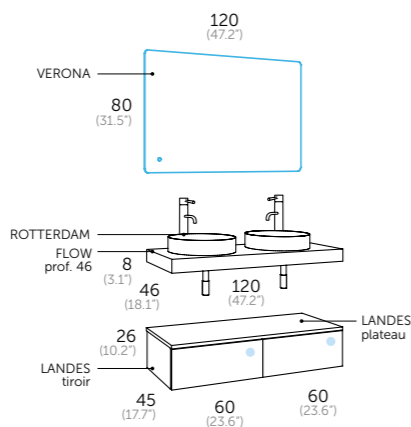

Chêne naturel  
Natural oak  
Rovere naturale  
Naturliche  
Natuurle eiken  
بلوط طبيعي

Pin gris  
Grey pine  
Pino-grigio  
Kiefer grau  
Grijs pijn  
سرو رمادي



Système anti buée. Anti fog system.  
Sistema antiappannamento.  
Anti Beschlag System.  
نظام ضد الضباب.  
Spiegelverwarming.  
Lumière ambient. Ambient light.  
Luce ambiente. Ambient Light.  
Omgevingslicht.  
Capteurs de contact. Contact sensor  
On/Off. Sensore di con tatto On/Off.  
Sensorschalter On/Off. Aanraken  
Schakelaar.  
Réversible. It is reversible. Reversible.  
Umkehrbar. Omkeerbaar. ja  
استعمال عكسي



Glissières métalliques. Metal interior  
drawers. Sistema di estrazione metallico.  
Metallzierleiste. Metalen zijkant.  
درج معدني  
Extraction e. extraction.  
Estrazione e. Komplette herausziehbar.  
Volledig uittrekbaar.  
لم ايك يورد حركت م اظن  
Fermeture ralentie. Soft close.  
Frenata soft close. Sanfter Verschluss.  
Zachtsluitend.  
Glissière Hettich. Hettich sliding  
system. Guide Hettich. Korpuschiene  
Hettich. Hettich lade system.  
مفصلات المانحة هيتش  
Mélamine structurée. Textured melamine.  
Melamina testurizzata. Textur mit  
Relief. Reliefstructuur.  
Réistant à l'eau. Resistant to water.  
Idrorepellente. Wasserfest.  
Waterafstotend.

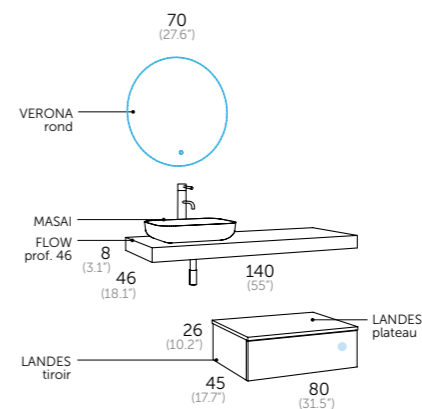

## flow.140

Composition | chêne naturel

1	138 24 140	<b>Flow 140 f46</b>
1	410 00 101	<b>Siphon chrome</b>
1	112 24 084	<b>Landes module tiroir</b>
1	112 24 208	<b>Landes plateau</b>
	422 02 000	<b>Poignée Line / noir</b>
1	518 02 051	<b>Masai noir</b>
1	247 00 070	<b>Verona rond</b>





Résistant à l'eau.  
Resistant to water.



Résistant à l'eau.  
Resistant to water.



ambar lip  
152  
Coycama

ambar lip  
153  
Coycama

## ambar lip.80

Composition | chêne naturel

1	524 01 080	<b>Ambar lip 80</b>
1	410 00 101	<b>Siphon chrome</b>
1	112 24 085	<b>Landes module creux</b>
1	112 24 208	<b>Landes plateau</b>
1	290 00 080	<b>Sigma</b>
1	400 00 141	<b>Sofia</b>

Robinet

1	412 00 800	<b>Combi chrome</b>
---	------------	---------------------



Mélamine structuré. Textured melamine.  
Melamina testurizzata. Textur mit Relief. Reliefsstruktur. ملمس منقوش



Résistant à l'eau. Resistant to water.  
Idrorepellente. Wasserfest.  
Waterafstotend. مقاوم للماء

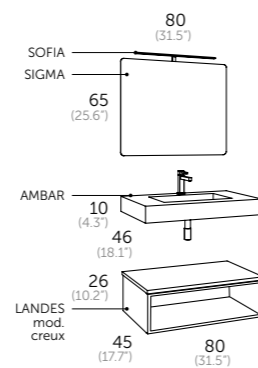

## ambar lip.100



Mélamine structuré. Textured melamine.  
Melamina testurizzata. Textur mit Relief. Reliefsstruktur. ملمس منقوش



Résistant à l'eau. Resistant to water.  
Idrorepellente. Wasserfest.  
Waterafstotend. مقاوم للماء



Système anti buée. Anti fog system.  
Sistema antiappannamento.  
Anti Beschlag System.  
Spiegelverwarming. نظام ضد الضباب



Lumière ambiant. Ambient light.  
Luce ambiente. Ambient Light.  
Omgevingslicht. إضاءة خلفية



Capteurs de contact. Contact sensor  
On/Off. Sensore di con tatto On/Off.  
Sensorschalter On/Off. Aanraken  
Schakelaar. حساس لمس انفتاح / تشغيل

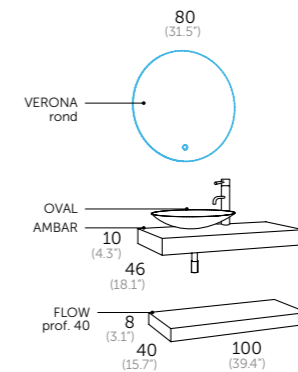

Composition | pin gris

1	524 01 101	<b>Ambar lip 100 plateau</b>
1	410 00 101	<b>Siphon chrome</b>
1	138 37 101	<b>Flow 100 f40</b>
1	509 01 001	<b>Oval</b>
1	247 00 080	<b>Verona rond</b>



Résistant à l'eau.  
Resistant to water.



# ambar lip.120

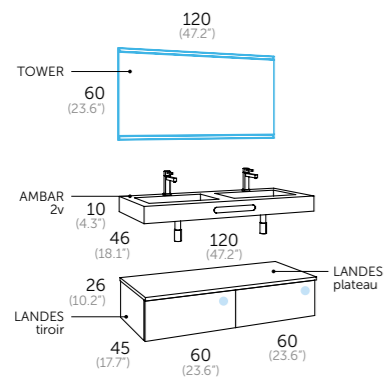

Composition | chêne naturel

1	524 01 120	<b>Ambar lip 120 2v.</b>
1	524 01 999	<b>Porte-serviettes</b>
2	410 00 101	<b>Siphon chrome</b>
2	112 24 064	<b>Landes module tiroir</b>
1	112 24 212	<b>Landes plateau</b>
	422 27 000	<b>Poignée Line / blanc</b>
1	262 00 120	<b>Tower</b>



Robinet

2	412 00 800	<b>Combi chrome</b>
---	------------	---------------------

- Glissières métalliques. Metal interior drawers. Sistema di estrazione metallico. Metallzierleiste. Metalen zijkanten. درج معدني
- Extraction e. extraction. Estrazione e. Komplet herausziehbar. Volledig uittrekbaar. لم اناك جرد حرتف ما اظن
- Fermeture ralentie. Soft close. Frenata soft close. Sanfter Verschluss. Zachtsluitend. نظام إغلاق انومائيكي
- Glissières Hettich. Hettich sliding system. Guide Hettich. Korpuschiene Hettich. Hettich lade system. مفصلات الماينة هيتش
- Melamine structuré. Textured melamine. Melamina testurizzata. Textur mit Relief. Reliefstructuur. ملمس منقوش
- Résistant à l'eau. Resistant to water. Idrorepellente. Wasserfest. Waterafstotend. مقاوم للماء
- Système anti buée. Anti fog system. Sistema antiappannamento. Anti Beschlag System. Spiegelverwarming. نظام ضد الضباب
- Capteurs de infrarouge. Infrared sensor On/Off. Sensore infrarosso On/Off. Infrarot Sensorschalter On/Off. Infrarood sensor. حساس بالونوت انفاء / تشغيل
- Réversible. It is reversible. Reversibile. Umkehrbar. Omkeerbaar. ja استعمال عكسي





## flow.60 (23,06")

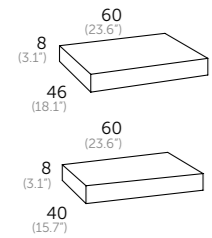

**f46** profondeur 46 cm

- Chêne naturel 138 24 060
- Pin gris 138 37 060

**f40** profondeur 40 cm

- Chêne naturel 138 24 061
- Pin gris 138 37 061

## flow.70 (27,55")

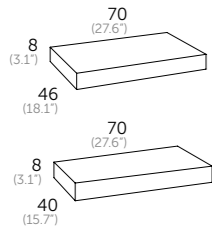

**f46** profondeur 46 cm

- Chêne naturel 138 24 070
- Pin gris 138 37 070

**f40** profondeur 40 cm

- Chêne naturel 138 24 071
- Pin gris 138 37 071

## flow.80 (31,05")

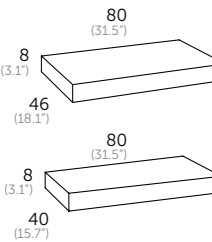

**f46** profondeur 46 cm

- Chêne naturel 138 24 080
- Pin gris 138 37 080

**f40** profondeur 40 cm

- Chêne naturel 138 24 081
- Pin gris 138 37 081

## flow.100 (39,40")

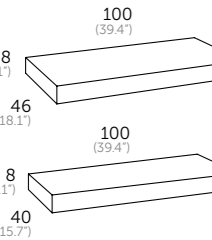

**f46** profondeur 46 cm

- Chêne naturel 138 24 100
- Pin gris 138 37 100

**f40** profondeur 40 cm

- Chêne naturel 138 24 101
- Pin gris 138 37 101

## flow.120 (47,02")

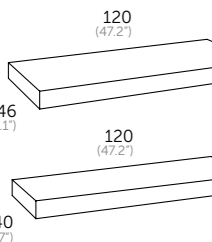

**f46** profondeur 46 cm

- Chêne naturel 138 24 120
- Pin gris 138 37 120

**f40** profondeur 40 cm

- Chêne naturel 138 24 121
- Pin gris 138 37 121

## flow.140 (55,1")

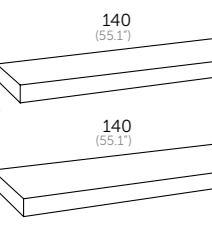

**f46** profondeur 46 cm

- Chêne naturel 138 24 140
- Pin gris 138 37 140

**f40** profondeur 40 cm

- Chêne naturel 138 24 141
- Pin gris 138 37 141

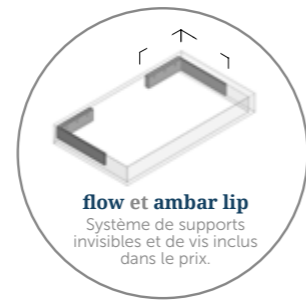

**flow et ambar lip**  
Système de supports invisibles et de vis inclus dans le prix.

## ambar.lip.70 (27,55")

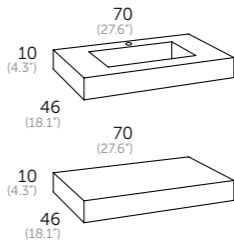

plan vasque / washbasin

Solid surface 524 01 070

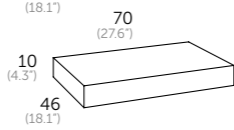

plateaux /countertop

Solid surface 524 01 071

## ambar.lip.80 (31,05")

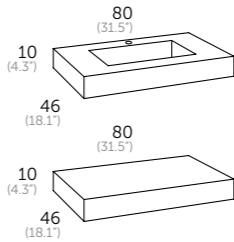

plan vasque / washbasin

Solid surface 524 01 080

## ambar.lip.100 (39,40")

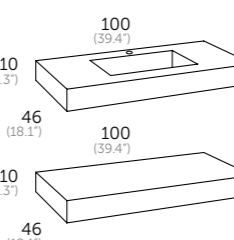

plan vasque / washbasin

Solid surface 524 01 100

## ambar.lip.120 (47,02")

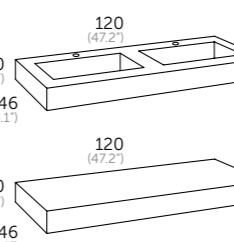

plan vasque / washbasin

Solid surface 524 01 120



plateaux /countertop

Solid surface 524 01 121

vasqué a poser



**ROTTERDAM**

Référence 507 01 004



**ESTAMBUL**

Référence 507 01 005



**SEI**

Référence 530 01 006



**TRE**

Référence 51 530 01 035  
61 530 01 036

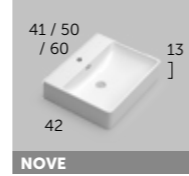

**NOVE**

Référence 41 530 01 094  
50 530 01 095  
60 530 01 096

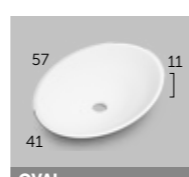

**OVAL**

Référence 509 01 001



**MASAI**

○ Blanc 518 01 051  
● Noir 518 02 051

Plus de couleurs à la page 289

## 60 cm. miroirs / mirrors / specchio / spiegel / spiegels / مرايا

PLAN VASQUES ET MIROIRS PLUS D'OPTIONS DANS LES PAGES 280 - 299

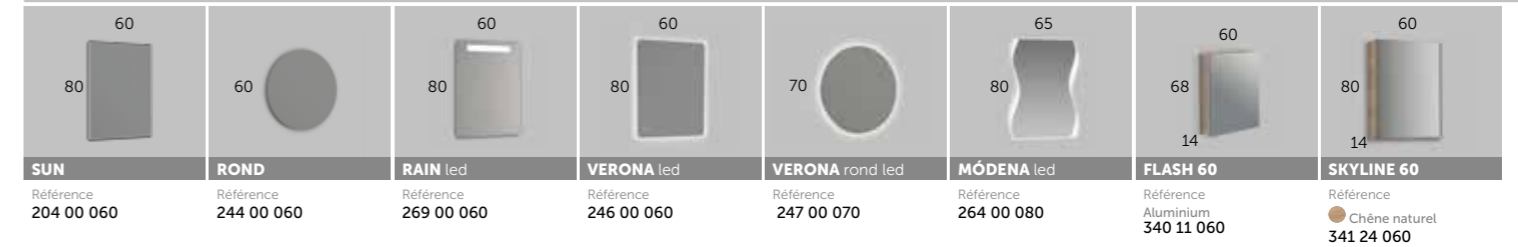

## 70 cm. miroirs / mirrors / specchio / spiegel / spiegels / مرايا

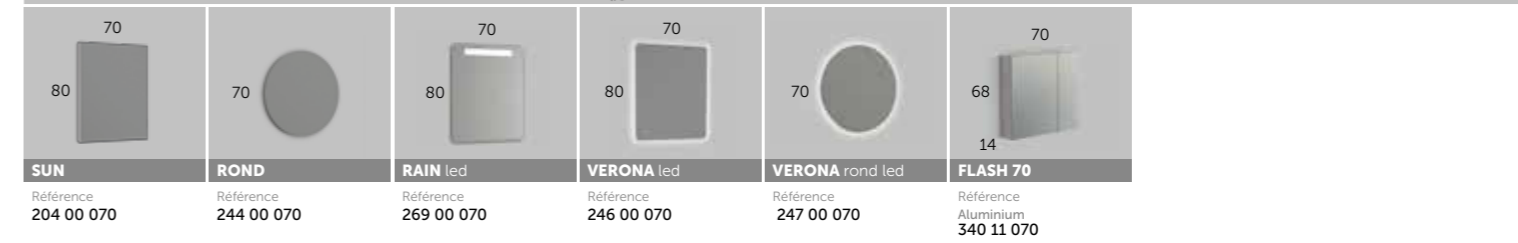

## 80 cm. miroirs / mirrors / specchio / spiegel / spiegels / مرايا



## 100 cm. miroirs / mirrors / specchio / spiegel / spiegels / مرايا

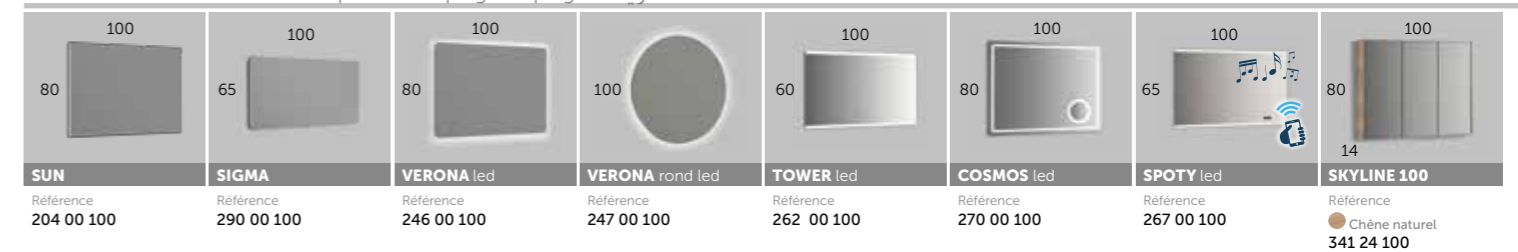

## 120 cm. espmiroirs / mirrors / specchio / spiegel / spiegels / مرايا



## 140 cm. miroirs / mirrors / specchio / spiegel / spiegels / مرايا



éclairage / spotlights







## epsilon.

60 / 80 / 100 / 120

Résine minérale revêtue de polyuréthane acrylique. disponible en 20 couleurs.

Surface traitement antibactérien.

Nettoyage facile, peuvent être nettoyés avec quasiment tous les produits d'entretien courants.

Made of mineral-filled polyurethane with acrylic coating. Available in 20 colours.

Antibacterial treatment area.

Easy cleaning, can be cleaned with almost all usual cleaning products.



Sur demande. On request.  
Délai de livraison 25 jours.



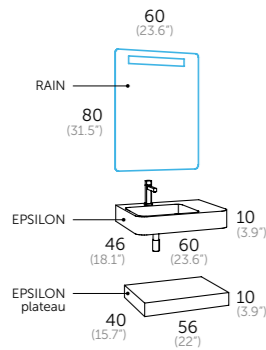

Composition | fango

1	594 18 060	<b>Epsilon 60 fango</b>
1	410 00 101	<b>Siphon chrome</b>
1	594 18 061	<b>Epsilon 60 plateau fango</b>
1	269 00 060	<b>Rain</b>

Robinet

1	412 18 800	<b>Combi / fango</b>
---	------------	----------------------

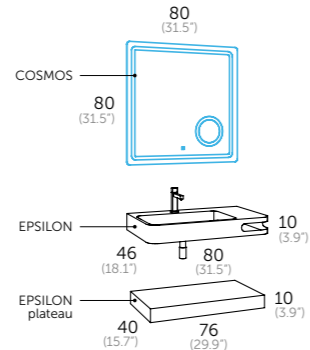

Composition | noir

1	594 02 080E	<b>Epsilon 80 noir</b>
1	410 00 101	<b>Siphon chrome</b>
1	594 02 081	<b>Epsilon 80 plateau noir</b>
1	270 00 080	<b>Cosmos</b>

Robinet

1	412 02 800	<b>Combi / noir</b>
---	------------	---------------------

# epsilon.60/80







Composition | blanc | chêne naturel

1	594 01 100L	<b>Epsilon 100 blanc</b>
1	410 00 101	<b>Siphon chrome</b>
1	138 24 101	<b>Flow 100 prof. 40</b>
1	246 00 100	<b>Verona 100</b>

Robinet

1	412 01 800	<b>Combi / blanc</b>
---	------------	----------------------

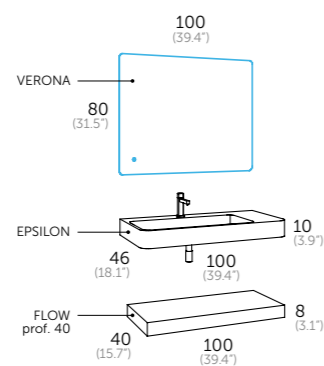

# epsilon.100

# epsilon.120

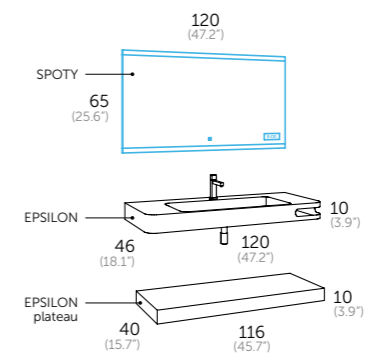

Composition | plomb

1	594 17 120E	<b>Epsilon 120 plomb</b>
1	410 00 101	<b>Siphon chrome</b>
1	594 17 121	<b>Epsilon 120 plateau plomb</b>
1	267 00 120	<b>Spoty</b>

Robinet

1	412 17 800	<b>Combi / plomb</b>
---	------------	----------------------

## epsilon.60 (23.6")

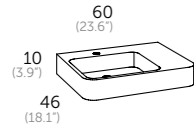

couleur	Référence*
Blanc	594 01 060
Gris ciment	594 09 060
Fango	594 18 060
Anthracite	594 03 060
Noir	594 02 060
Aubergine	594 11 060
Pourpre	594 12 060
Beige	594 05 060
Moka	594 19 060
Terre	594 20 060
Tropic	594 30 060
Turquoise	594 31 060
Ocean	594 32 060
<b>Métallisé</b>	
Mustard métallisé	594 33 060
Cooper métallisé	594 34 060
Brun métallisé	594 08 060
Noir métallisé	594 04 060
<b>Métaux</b>	
Argent métaux	594 15 060
Or métaux	594 16 060
Plomb métaux	594 17 060

## plateaux.60 (23.6")

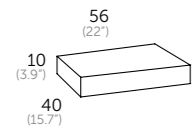

couleur	Référence*
Blanc	594 01 061
Gris ciment	594 09 061
Fango	594 18 061
Anthracite	594 03 061
Noir	594 02 061
Aubergine	594 11 061
Pourpre	594 12 061
Beige	594 05 061
Moka	594 19 061
Terre	594 20 061
Tropic	594 30 061
Turquoise	594 31 061
Ocean	594 32 061
<b>Métallisé</b>	
Mustard métallisé	594 33 061
Cooper métallisé	594 34 061
Brun métallisé	594 08 061
Noir métallisé	594 04 061
<b>Métaux</b>	
Argent métaux	594 15 061
Or métaux	594 16 061
Plomb métaux	594 17 061

Résine à charge minérale avec revêtement acrylique polyuréthane.  
Made of acrylic coated mineral filler polyurethane.

Le plateau est en MDF laqué. Supports invisibles inclus.  
The shelf is made of MDF lacquered. Invisible supports are included.

Sur demande. Délai de livraison 25 jours.



## epsilon.80 (31.5")

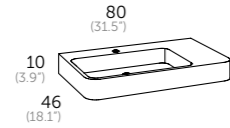

couleur	Référence*
Blanc	594 01 080
Gris ciment	594 09 080
Fango	594 18 080
Anthracite	594 03 080
Noir	594 02 080
Aubergine	594 11 080
Pourpre	594 12 080
Beige	594 05 080
Moka	594 19 080
Terre	594 20 080
Tropic	594 30 080
Turquoise	594 31 080
Ocean	594 32 080
<b>Métallisé</b>	
Mustard métallisé	594 33 080
Cooper métallisé	594 34 080
Brun métallisé	594 08 080
Noir métallisé	594 04 080
<b>Métaux</b>	
Argent métaux	594 15 080
Or métaux	594 16 080
Plomb métaux	594 17 080

## plateaux.80 (31.5")

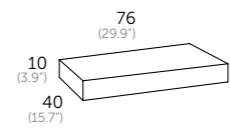

couleur	Référence*
Blanc	594 01 081
Gris ciment	594 09 081
Fango	594 18 081
Anthracite	594 03 081
Noir	594 02 081
Aubergine	594 11 081
Pourpre	594 12 081
Beige	594 05 081
Moka	594 19 081
Terre	594 20 081
Tropic	594 30 081
Turquoise	594 31 081
Ocean	594 32 081
<b>Métallisé</b>	
Mustard métallisé	594 33 081
Cooper métallisé	594 34 081
Brun métallisé	594 08 081
Noir métallisé	594 04 081
<b>Métaux</b>	
Argent métaux	594 15 081
Or métaux	594 16 081
Plomb métaux	594 17 081

## epsilon.100 (39.4")

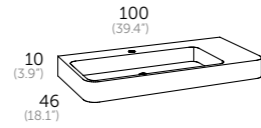

couleur	Référence*
Blanc	594 01 100
Gris ciment	594 09 100
Fango	594 18 100
Anthracite	594 03 100
Noir	594 02 100
Aubergine	594 11 100
Pourpre	594 12 100
Beige	594 05 100
Moka	594 19 100
Terre	594 20 100
Tropic	594 30 100
Turquoise	594 31 100
Ocean	594 32 100
<b>Métallisé</b>	
Mustard métallisé	594 33 100
Cooper métallisé	594 34 100
Brun métallisé	594 08 100
Noir métallisé	594 04 100
<b>Métaux</b>	
Argent métaux	594 15 100
Or métaux	594 16 100
Plomb métaux	594 17 100

## plateaux.100 (39.4")

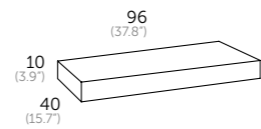

couleur	Référence*
Blanc	594 01 101
Gris ciment	594 09 101
Fango	594 18 101
Anthracite	594 03 101
Noir	594 02 101
Aubergine	594 11 101
Pourpre	594 12 101
Beige	594 05 101
Moka	594 19 101
Terre	594 20 101
Tropic	594 30 101
Turquoise	594 31 101
Ocean	594 32 101
<b>Métallisé</b>	
Mustard métallisé	594 33 101
Cooper métallisé	594 34 101
Brun métallisé	594 08 101
Noir métallisé	594 04 101
<b>Métaux</b>	
Argent métaux	594 15 101
Or métaux	594 16 101
Plomb métaux	594 17 101

**Option porte-serviette / towel rail:**  
La position du porte-serviette peut être le latéral droit ou dans le coin droit.  
The towel rail can be positioned on the right-hand side or in the right-hand corner.

\* Ajouter à la référence: Porte-serviettes latérale (L), angle (E)



## epsilon.120 (47.2")

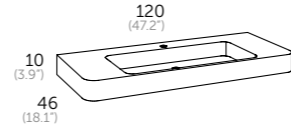

couleur	Référence*
Blanc	594 01 120
Gris ciment	594 09 120
Fango	594 18 120
Anthracite	594 03 120
Noir	594 02 120
Aubergine	594 11 120
Pourpre	594 12 120
Beige	594 05 120
Moka	594 19 120
Terre	594 20 120
Tropic	594 30 120
Turquoise	594 31 120
Ocean	594 32 120
<b>Métallisé</b>	
Mustard métallisé	594 33 120
Cooper métallisé	594 34 120
Brun métallisé	594 08 120
Noir métallisé	594 04 120
<b>Métaux</b>	
Argent métaux	594 15 120
Or métaux	594 16 120
Plomb métaux	594 17 120

## plateaux.120 (47.2")

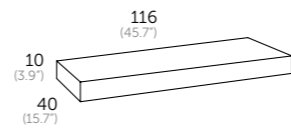

couleur	Référence*
Blanc	594 01 121
Gris ciment	594 09 121
Fango	594 18 121
Anthracite	594 03 121
Noir	594 02 121
Aubergine	594 11 121
Pourpre	594 12 121
Beige	594 05 121
Moka	594 19 121
Terre	594 20 121
Tropic	594 30 121
Turquoise	594 31 121
Ocean	594 32 121
<b>Métallisé</b>	
Mustard métallisé	594 33 121
Cooper métallisé	594 34 121
Brun métallisé	594 08 121
Noir métallisé	594 04 121
<b>Métaux</b>	
Argent métaux	594 15 121
Or métaux	594 16 121
Plomb métaux	594 17 121

## 60 cm. miroirs / mirrors / specchio / spiegel / spiegels / مرايا

PLAN VASQUES ET MIROIRS PLUS D'OPTIONS DANS LES PAGES 280 - 299

Référence 204 00 060	Référence 244 00 060	Référence 269 00 060	Référence 246 00 060	Référence 247 00 070	Référence 264 00 080	Référence Aluminium 340 11 060	Référence Aluminium 341 11 060

## 80 cm. miroirs / mirrors / specchio / spiegel / spiegels / مرايا

Référence 204 00 080	Référence 290 00 080	Référence 246 00 100	Référence 247 00 080	Référence 262 00 080	Référence 270 00 080	Référence 267 00 080	Référence Aluminium 341 11 080

## 100 cm. miroirs / mirrors / specchio / spiegel / spiegels / مرايا

Référence 204 00 100	Référence 290 00 100	Référence 246 00 100	Référence 247 00 100	Référence 262 00 100	Référence 270 00 100	Référence 267 00 100	Référence Aluminium 341 11 100

## 120 cm. miroirs / mirrors / specchio / spiegel / spiegels / مرايا

Référence 204 00 120	Référence 269 00 120	Référence 246 00 120	Référence 270 00 120	Référence Aluminium 341 11 120

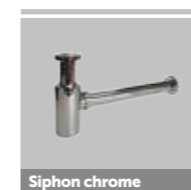

Siphon chrome  
Référence  
410 00 101

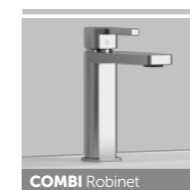

COMBI Robinet  
● Chrome  
412 00 800  
● Chêne Naturel  
412 24 800

couleur	Référence
Blanc	412 01 800
Gris ciment	412 09 800
Fango	412 18 800
Anthracite	412 03 800
Noir	412 02 800
Aubergine	412 11 800
Pourpre	412 12 800
Beige	412 05 800
Moka	412 19 800
Terre	412 20 800
Tropic	412 30 800
Turquoise	412 31 800
Ocean	412 32 800

Métallisé	Référence
Mustard métallisé	412 33 800
Cooper métallisé	412 34 800
Brun métallisé	412 08 800
Noir métallisé	412 04 800
<b>Métaux</b>	
Argent métaux	412 15 800
Or métaux	412 16 800
Plomb métaux	412 17 800

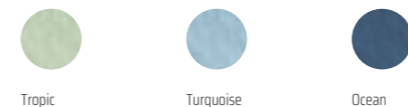

### Métallisé



### Métaux



## éclairage / spotlights



NEREA MAT  
Référence  
Lumière froide 6000k  
400 14 161



ESTHER BLACK 30  
Référence  
Lumière froide 6000k  
400 02 121

SOFIA 60  
Référence  
Lumière froide 6000k  
400 00 141





# oslo.

70 / 80 / 100 / 120



brillant  
glossy



mat  
matte





Blanc brillant  
Glossy white  
Bianco lucido  
Weiss hochglanz  
Witte glanz  
أبيض لميع لكر



Blanc mat  
Matte white  
Bianco opaco  
Weiß matt  
Mat wit  
أبيض مت



Chêne naturel  
Natural oak  
Rovere naturale  
Naturele eiken  
بلوط طبيعي



Pin gris  
Grey pine  
Pino-grigio  
Kiefer grau  
Grijs pijn  
سرو رمادي



Wenge nature  
بني غامق طبيعي



Finition texture. Texture finish. Finitura trama. Textur-Finish. Textuur afwerking. الانتهاء من الملمس



Fermeture ralentie. Soft close. Frenata soft close. Sanfter Verschluss. Zachtsluitend. نظام إغلاق أوتوماتيكي.



Organisateur. Organizer unit. Organizzatore. Obere Ablage. Superieure organizer. منظم درج علوي.



Façades réglables. Adjustable front. Frontali regolabili. Einstellbare Vorderseite. Verstelbaar front. الدروج الامامية قابلة للتعديل.



Glissières Hettich. Hettich sliding system. Guide Hettich. Korpussschiene Hettich. Hettich lade system. مفصلات المانيه هيتش



Fermeture ralentie. Soft close. Frenata soft close. Sanfter Verschluss. Zachtsluitend. نظام إغلاق أوتوماتيكي.



Melamine structurée. Textured melamine. Melamina testurizzata. Textur mit Relief. Reliefstructuur. ملمس منقوش.

# oslo.70

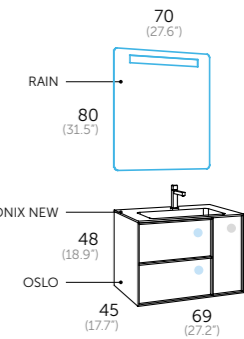

Composition | pin gris

1 142 37 070 **Oslo 70**

1 550 01 070 **Onix new**

1 269 00 070 **Rain**



Robinet

1 412 00 800 **Combi chrome**





Blanc brillant  
Glossy white  
Bianco lucido  
Weiss hochglanz  
Witte glans  
أبيض لميع لكر



Blanc mat  
Matte white  
Bianco opaco  
Weiß matt  
Mat wit  
أبيض مت



Chêne naturel  
Natural oak  
Rovere naturale  
Natureiche  
Naturel eiken  
بلوط طبيعي



Pin gris  
Grey pine  
Pino-grigio  
Kiefer grau  
Grijs pijn  
سرو رمادي



Wenge nature  
بني غامق طبيعي



Finition texture. Texture finish. Finitura trama. Textur-Finish. Textuur afwerking. الانتهاء من الملمس



Fermeture ralentie. Soft close. Frenata soft close. Sanfter Verschluss. Zachtsluitend. نظام إغلاق أوتوماتيكي



Organisateur. Organizer unit. Organizzatore. Obere Ablage. Superieure organizer. منظم درج علوي



Façades réglables. Adjustable front. Frontali regolabili. Einstellbare Vorderseite. Verstelbaar front. الدروج الامامية قابلة للتعديل



Glissières Hettich. Hettich sliding system. Guide Hettich. Korpussschiene Hettich. Hettich lade system. مفصلات الجانية هيتش



Fermeture ralentie. Soft close. Frenata soft close. Sanfter Verschluss. Zachtsluitend. نظام إغلاق أوتوماتيكي



Mélamine structuré. Textured melamine. Melamina testurizzata. Textur mit Relief. Relieffstructuur. ملمس منقوش



Système anti buée. Anti fog system. Sistema antiappannamento. Anti Beschlag System. نظام ضد الضباب



Lumière ambient. Ambient light. Luce ambiente. Ambient Light. أضواء خلفية



Capteurs de contact. Contact sensor On/Off. Sensore di con tatto On/Off. Sensorschalter On/Off. Aanraken Schakelaar. حساس لمس انفتاح / تشغيل



Réversible. It is reversible. Reversibile. Umkehrbar. Omkeerbaar. ja استعمال عكسي

## oslo.80

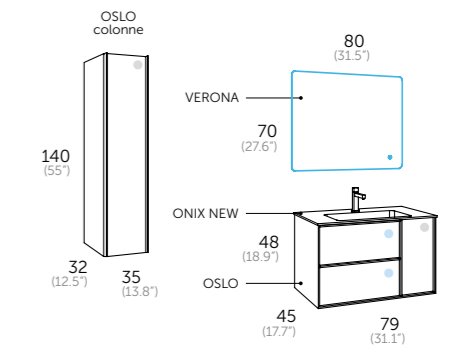

Composition | chêne naturel

1	142 24 080	<b>Oslo 80</b>
1	550 01 080	<b>Onix new</b>
1	246 00 070	<b>Verona</b>

Auxiliaires

1	142 24 335	<b>Colonne</b>
---	------------	----------------



1	412 00 800	<b>Combi chrome</b>
---	------------	---------------------

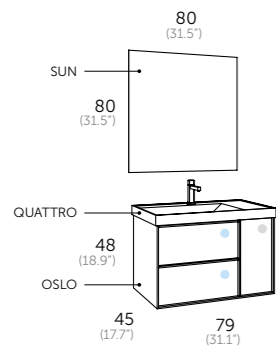

## Composition | wenge nature

1	142 44 080	<b>Oslo 80</b>
1	521 01 080	<b>Quattro</b>
1	204 00 080	<b>Sun</b>



## Robinet

1	412 00 800	<b>Combi chrome</b>
---	------------	---------------------

## oslo.80

Finition texture. Texture finish. Finitura trama. Textur-Finish. Textuur afwerking. الانتهاء من الملمس

Fermeture ralentie. Soft close. Frenata soft close. Sanfter Verschluss. Zachtsluitend. نظام إغلاق أوتوماتيكي.

Organisateur. Organizer unit. Organizzatore. Obere Ablage. Superieure organizer. منظم درج علوي.

Façades réglables. Adjustable front. Frontali regolabili. Einstellbare Vorderseite. Verstelbaar front. الدروج الامامية قابلة للتعديل.

Glissières Hettich. Hettich sliding system. Guide Hettich. Korpusschiene Hettich. Hettich lade system. مفصلات المانوية هيتش.

Fermeture ralentie. Soft close. Frenata soft close. Sanfter Verschluss. Zachtsluitend. نظام إغلاق أوتوماتيكي.

Melamine structuré. Textured melamine. Melamina testurizzata. Textur mit Relief. Relief-structuur. ملمس منقوش.



Blanc brillant  
Glossy white  
Bianco lucido  
Weiss hochglanz  
Witte glans  
أبيض لميع لكر



Blanc mat  
Matte white  
Bianco opaco  
Weiß matt  
Mat wit  
أبيض مت



Chêne naturel  
Natural oak  
Rovere naturale  
Naturele eiken  
بلوط طبيعي



Pin gris  
Grey pine  
Pino-grigio  
Kiefer grau  
Grijs pijn  
سرو رمادي



Wenge nature  
بني غامق طبيعي

## oslo.100

Système anti buée. Anti fog system. Sistema antiappannamento. Anti Beschlag System. Spiegelverwarming. نظام ضد الضباب.

Lumière ambient. Ambient light. Luce ambiente. Ambient Light. Omgevingslicht. اضاءة خلفية.

Montre digitale. Digital clock. Orologio digitale. Digitaluhr. Digitale klok. ساعة رقمية.

Capteurs de contact. Contact sensor On/Off. Sensore di con tatto On/Off. Sensorschalter On/Off. Aanraken Schakelaar. حساس لمس اطفاء / تشغيل.

Lecteur de musique intégré, connection Bluetooth. 2 Haut-parleurs 3W chacun. Built in music player, bluetooth connection. 2 speakers of 3W each. Lettore musicale integrato, connessione a Bluetooth. 2 altoparlanti 3W ciascuno. Musik Player integriert, Bluetooth Anschluss. 2 Lautsprecher je mit 3W. Muziekspeler: 2 speakers 3W elke. مسجلة داخلية بلوتوث 2 مكبر صوت 3 واط كل واحد.

Finition texture. Texture finish. Finitura trama. Textur-Finish. Textuur afwerking. الانتهاء من الملمس

Fermeture ralentie. Soft close. Frenata soft close. Sanfter Verschluss. Zachtsluitend. نظام إغلاق أوتوماتيكي.

Organisateur. Organizer unit. Organizzatore. Obere Ablage. Superieure organizer. منظم درج علوي.

Façades réglables. Adjustable front. Frontali regolabili. Einstellbare Vorderseite. Verstelbaar front. الدروج الامامية قابلة للتعديل.

Glissières Hettich. Hettich sliding system. Guide Hettich. Korpusschiene Hettich. Hettich lade system. مفصلات المانوية هيتش.

Fermeture ralentie. Soft close. Frenata soft close. Sanfter Verschluss. Zachtsluitend. نظام إغلاق أوتوماتيكي.

Laquée mate. Matte lacquered finish. Laccato opaco. Matt lackiert. Mat gelakt. لكر مت

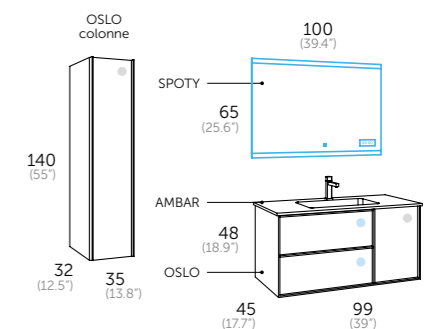

## Composition | blanc mat

1	142 27 100	<b>Oslo 100</b>
1	506 01 100	<b>Ambar</b>
1	267 00 100	<b>Spoty</b>

## Auxiliaires

1	142 27 335	<b>Colonne</b>
---	------------	----------------



## Robinet

1	412 00 800	<b>Combi chrome</b>
---	------------	---------------------



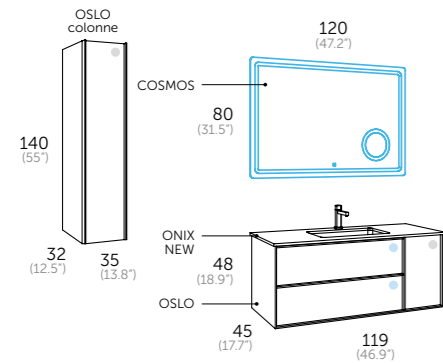

## Composition | blanc brillant

1	142 01 120	<b>Oslo 120</b>
1	550 01 120	<b>Onix new 1v.</b>
1	270 00 120	<b>Cosmos</b>

## Auxiliaires

1	142 01 335	<b>Colonne</b>
---	------------	----------------



## Robinet

1	412 00 800	<b>Combi chrome</b>
---	------------	---------------------

## oslo.120

Finition texture. Texture finish. Finitura trama. Textur-Finish. Textuur afwerking. الانتهاء من الملمس

Fermeture ralentie. Soft close. Frenata soft close. Sanfter Verschluss. Zachtsluitend. نظام إغلاق أوتوماتيكي.

Organisateur. Organizer unit. Organizzatore. Obere Ablage. Superieure organizer. منظم درج علوي.

Façades réglables. Adjustable front. Frontali regolabili. Einstellbare Vorderseite. Verstellbaar front. الدروج الامامية قابلة للتعديل.

Glissières Hettich. Hettich sliding system. Guide Hettich. Körperschiene Hettich. Hettich lade system. مفصلات الجانبيهتيش

Fermeture ralentie. Soft close. Frenata soft close. Sanfter Verschluss. Zachtsluitend. نظام إغلاق أوتوماتيكي.

Laquéé brillant. Glossy lacquered finish. Laccato lucido. Glanzend lackiert. Hoogglans gelakt. لكر ليح.

Système anti buée. Anti fog system. Sistema antiappannamento. Anti Beschlag System. Spiegelverwarming. نظام ضد الضباب.

Capteurs de contact. Contact sensor On/Off. Sensore di con tatto On/Off. Sensorschalter On/Off. Aanraken Schakelaar. حساسي لمس اطفاء / تشغيل.

Miroir loupe 3x éclairé. Magnifying zoom in Mirror. Lente d'ingrandimento 3x. Lupe 3x Vergrößerung. Vergrootglas: verhoging x 3. مكبررؤية 3 أضعاف.



Blanc brillant  
Glossy white  
Bianco lucido  
Weiss hochglanz  
Witte glans  
أبيض ليح لكر



Blanc mat  
Matte white  
Bianco opaco  
Weiß matt  
Mat wit  
أبيض مت



Chêne naturel  
Natural oak  
Rovere naturale  
Naturele eiken  
بلوط طبيعي



Pin gris  
Grey pine  
Pino-grigio  
Kiefer grau  
Grijs pijn  
سرو رمادي



Wenge nature  
بني غامق طبيعي



oslo.70 (27.55")

plan vasque / washbasin / lavabo / waschtisch / wastafels / تروس

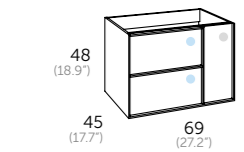

Finition	Référence
○ Blanc brillant	142 01 070
○ Blanc mat	142 27 070
● Chêne naturel	142 24 070
● Pin gris	142 37 070
● Wenge nature	142 44 070



ONIX NEW céramique	AMBAR mat	MASAI	MASAI plateaux	AMBAR plateaux
Référence 550 01 070	Référence 506 01 070	Référence ○ Blanc 518 01 070 ● Noir 518 02 070	Référence ○ Blanc 519 01 070 ● Noir 519 02 070	Référence 508 01 070

Plus de couleurs à la page 284 Plus de couleurs à la page 286

oslo.80 (31.49")

plan vasque / washbasin / lavabo / waschtisch / wastafels / تروس

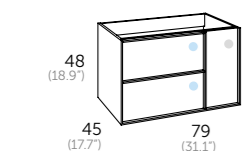

Finition	Référence
○ Blanc brillant	142 01 080
○ Blanc mat	142 27 080
● Chêne naturel	142 24 080
● Pin gris	142 37 080
● Wenge nature	142 44 080

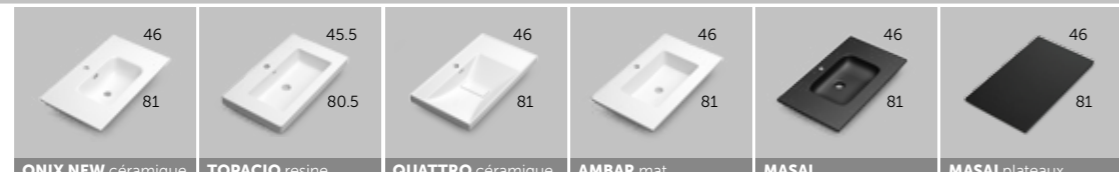

ONIX NEW céramique	TOPACIO résine	QUATTRO céramique	AMBAR mat	MASAI	MASAI plateaux
Référence 550 01 080	Référence 505 01 080	Référence 521 01 080	Référence 506 01 080	Référence ○ Blanc 518 01 080 ● Noir 518 02 080	Référence ○ Blanc 519 01 080 ● Noir 519 02 080

Plus de couleurs à la page 284 Plus de couleurs à la page 286

oslo.100 (39.37")

plan vasque / washbasin / lavabo / waschtisch / wastafels / تروس

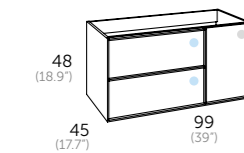

Finition	Référence
○ Blanc brillant	142 01 100
○ Blanc mat	142 27 100
● Chêne naturel	142 24 100
● Pin gris	142 37 100
● Wenge nature	142 44 100



ONIX NEW céramique	TOPACIO résine	QUATTRO céramique	AMBAR mat	MASAI	MASAI plateaux
Référence 550 01 100	Référence 505 01 100	Référence 521 01 100	Référence 506 01 100	Référence ○ Blanc 518 01 100 ● Noir 518 02 100	Référence ○ Blanc 519 01 100 ● Noir 519 02 100

Plus de couleurs à la page 284 Plus de couleurs à la page 286

oslo.120 (47.24")

plan vasque / washbasin / lavabo / waschtisch / wastafels / تروس

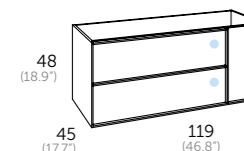

Finition	Référence
○ Blanc brillant	142 01 120
○ Blanc mat	142 27 120
● Chêne naturel	142 24 120
● Pin gris	142 37 120
● Wenge nature	142 44 120



ONIX NEW céramique	TOPACIO résine	AMBAR mat	MASAI	MASAI plateaux	AMBAR plateaux
Référence 550 01 120	Référence 505 01 120	Référence 506 01 120	Référence ○ Blanc 518 01 120 ● Noir 518 02 120	Référence ○ Blanc 519 01 120 ● Noir 519 02 120	Référence 508 01 120

Plus de couleurs à la page 284 Plus de couleurs à la page 286

landes.plateaux

avec barre de renfort en aluminium

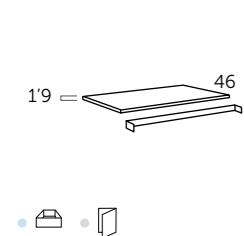

70	112 24 207	112 37 207
80	112 24 208	112 37 208
100	112 24 210	112 37 210
120	112 24 212	112 37 212

vasque à poser / over countertop basins

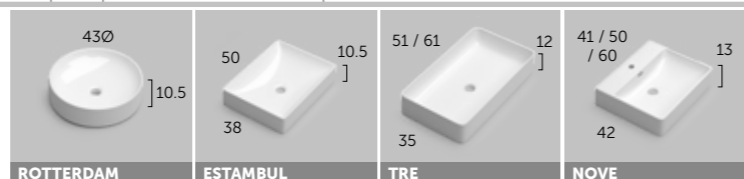

ROTTERDAM	ESTAMBUL	TRE	NOVE
Référence 507 01 004	Référence 507 01 005	Référence 51 / 61 61 / 50 530 01 035 530 01 036	Référence 41 / 50 530 01 094 530 01 095 530 01 096

miroirs / mirrors / specchio / spiegel / spiegels / مرايا

PLAN VASQUES ET MIROIRS PLUS D'OPTIONS DANS LES PAGES 280 - 299



SUN	ROND	RAIN led	VERONA led	VERONA rond led	FLASH 70
Référence 204 00 070	Référence 244 00 070	Référence 269 00 070	Référence 246 00 070	Référence 247 00 070	Référence Aluminium 340 11 070

miroirs / mirrors / specchio / spiegel / spiegels / مرايا



SUN	SIGMA	VERONA led	VERONA rond led	TOWER led	COSMOS led	SPOTY led	SKYLINE 80 armoire
Référence 204 00 080	Référence 290 00 080	Référence 246 00 100	Référence 247 00 080	Référence 262 00 080	Référence 270 00 080	Référence 267 00 080	Référence ○ Blanc brillant 341 01 080 ● Chêne naturel 341 24 080

Plus de couleurs à la page 298

miroirs / mirrors / specchio / spiegel / spiegels / مرايا



SUN	SIGMA	VERONA led	VERONA rond led	TOWER led	COSMOS led	SPOTY led	SKYLINE 100 armoire
Référence 204 00 100	Référence 290 00 100	Référence 246 00 100	Référence 247 00 100	Référence 262 00 100	Référence 270 00 100	Référence 267 00 100	Référence ○ Blanc brillant 341 01 100 ● Chêne naturel 341 24 100

Plus de couleurs à la page 298

miroirs / mirrors / specchio / spiegel / spiegels / مرايا



SUN	RAIN led	VERONA led	COSMOS led	SKYLINE 120
Référence 204 00 120	Référence 269 00 120	Référence 246 00 120	Référence 270 00 120	Référence ○ Blanc brillant 341 01 120 ● Chêne naturel 341 24 120

Plus de couleurs à la page 298

auxiliaires / auxiliary units

oslo.colonne

Finition	Référence
○ Blanc brillant	142 01 335
○ Blanc mat	142 27 335
● Chêne naturel	142 24 335
● Pin gris	142 37 335
● Wenge nature	142 44 335

Ouverture réversible | Reversible opening

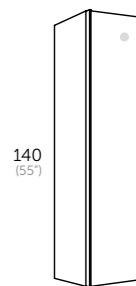

32 (12.5") 35 (13.8")

pieds / legs

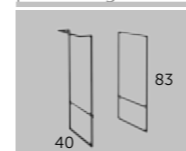

Kit Industrial (Réversible)  
Pour meuble 48 cm hauteur  
● Noir  
412 02 715



● Chrome  
410 00 203 Plus de couleurs à la page 330  
● Chrome  
412 00 800 Plus de couleurs à la page 291

joker.colonne haute

Finition	Référence
○ Blanc brillant	137 01 435
● Chêne naturel	137 24 435
● Pin gris	137 37 435
● Wenge nature	137 44 435

Ouverture réversible | Reversible opening

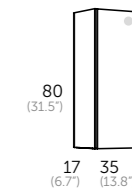

17 (6.7") 35 (13.8")





# praga.

60 / 70 / 80 / 100 / 120







Finition texture. Texture finish. Finitura trama. Textur-Finish. Textuur afwerking. الانتهاء من الملمس



Fermeture ralentie. Soft close. Frenata soft close. Sanfter Verschluss. Zachtsluitend. نظام إغلاق أوتوماتيكي



Organisateur. Organizer unit. Organizzatore. Obere Ablage. Superieure organizer. منظم درج علوي



Façades réglables. Adjustable front. Frontali regolabili. Einstellbare Vorderseite. Verstelbaar front. الدروج الامامية قابلة للتعديل



Glissières Hettich. Hettich sliding system. Guide Hettich. Korpussschiene Hettich. Hettich lade system. مفصلات الهيكلية



Mélamine structuré. Textured melamine. Melamina testurizzata. Textur mit Relief. Reliefstructuur. ملمس متقوش



## praga.60

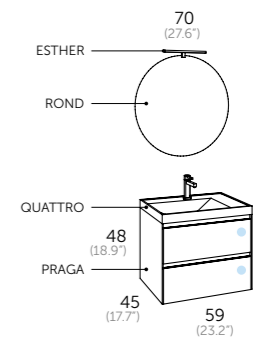

### Composition | pin gris

1	162 37 060	<b>Praga 60</b>
1	521 01 060	<b>Quattro</b>
1	244 00 070	<b>Rond</b>
1	400 00 121	<b>Esther</b>



### Robinet

1	412 00 800	<b>Combi chrome</b>
---	------------	---------------------



Blanc brillant  
Glossy white  
Bianco lucido  
Weiss hochglanz  
Witte glans  
أبيض لميع لكر



Chêne naturel  
Natural oak  
Rovere naturale  
Natureiche  
Natuurle eiken  
بلوط طبيعي



Pin gris  
Grey pine  
Pino-grigio  
Kiefer grau  
Grijs pijn  
سرو رمادي



Wenge nature  
بني غامق طبيعي



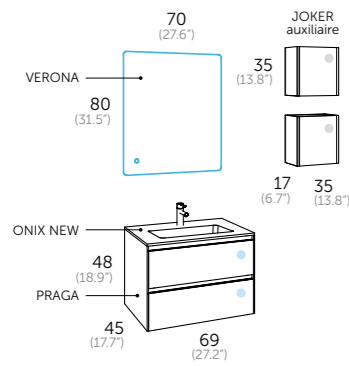

## Composition | wenge nature

1	162 44 070	<b>Praga 70</b>
1	550 01 070	<b>Onix new</b>
1	246 00 070	<b>Verona</b>

## Auxiliaires

2	137 44 445	<b>Joker auxiliaire</b>
---	------------	-------------------------



## Robinet

1	412 00 800	<b>Combi chrome</b>
---	------------	---------------------

## praga.70

Finition texture. Texture finish. Finitura trama. Textur-Finish. Textuur afwerking. الانتهاء من الملمس

Fermeture ralentie. Soft close. Frenata soft close. Sanfter Verschluss. Zachtsluitend. نظام إغلاق أوتوماتيكي.

Organisateur. Organizer unit. Organizzatore. Obere Ablage. Superieure organizer. منظم درج علوي.

Façades réglables. Adjustable front. Frontali regolabili. Einstellbare Vorderseite. Verstelbaar front. الدروج الأمامية قابلة للتعديل.

Glissières Hettich. Hettich sliding system. Guide Hettich. Korpuschiene Hettich. Hettich lade system. مفصلات المانعة هيتش.

Fermeture ralentie. Soft close. Frenata soft close. Sanfter Verschluss. Zachtsluitend. نظام إغلاق أوتوماتيكي.

Mélamine structuré. Textured melamine. Melamina testurizzata. Textur mit Relief. Reliefsstructuur. ملمس منقوش.

Système anti buée. Anti fog system. Sistema antiappannamento. Anti Beschlag System. Spiegelverwarming. نظام ضد الضباب.

Lumière ambient. Ambient light. Luce ambiente. Ambient Light. Omgevingslicht. اضاءة خلفية.

Capteurs de contact. Contact sensor On/Off. Sensore di con tatto On/Off. Sensorschalter On/Off. Aanraken Schakelaar. حساس لمس اطفاء / تشغيل.

Réversible. It is reversible. Reversibile. Umkehrbar. Omkeerbaar: ja. استعمال عكسي.



Blanc brillant  
Glossy white  
Bianco lucido  
Weiss hochglanz  
Witte glans  
أبيض لمع لكر



Chêne naturel  
Natural oak  
Rovere naturale  
Natureiche  
Naturel eiken  
بلوط طبيعي



Pin gris  
Grey pine  
Pino-grigio  
Kiefer grau  
Grijs pijn  
سرو رمادي



Wenge nature  
بني غامق طبيعي



## praga.80

Finition texture. Texture finish. Finitura trama. Textur-Finish. Textuur afwerking. الانتهاء من الملمس

Fermeture ralentie. Soft close. Frenata soft close. Sanfter Verschluss. Zachtsluitend. نظام إغلاق أوتوماتيكي.

Organisateur. Organizer unit. Organizzatore. Obere Ablage. Superieure organizer. منظم درج علوي.

Façades réglables. Adjustable front. Frontali regolabili. Einstellbare Vorderseite. Verstelbaar front. الدروج الأمامية قابلة للتعديل.

Glissières Hettich. Hettich sliding system. Guide Hettich. Korpuschiene Hettich. Hettich lade system. مفصلات المانعة هيتش.

Fermeture ralentie. Soft close. Frenata soft close. Sanfter Verschluss. Zachtsluitend. نظام إغلاق أوتوماتيكي.

Mélamine structuré. Textured melamine. Melamina testurizzata. Textur mit Relief. Reliefsstructuur. ملمس منقوش.

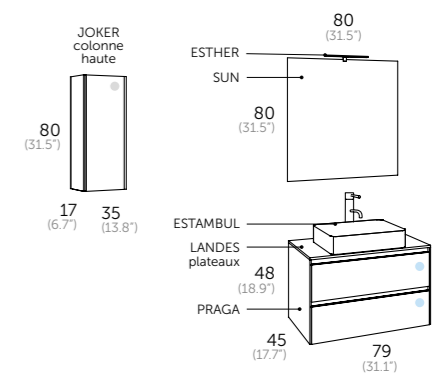

## Composition | chêne naturel

1	162 24 080	<b>Praga 80</b>
1	112 24 208	<b>Landes plateau</b>
1	507 01 005	<b>Estambul</b>
1	204 00 080	<b>Sun</b>
1	400 00 121	<b>Esther</b>

## Auxiliaires

1	137 24 435	<b>Joker colonne haute</b>
---	------------	----------------------------







## praga.100

- Blanc brillant  
Glossy white  
Blanco lucido  
Weiss hochglanz  
Witte glans  
أبيض قيع لكر
- Chêne naturel  
Natural oak  
Rovere naturale  
Natureiche  
Naturel eiken  
بلوط طبيعي
- Pin gris  
Grey pine  
Pino-grigio  
Kiefer grau  
Grijs pijn  
سرو رمادي
- Wenge nature  
بني غامق طبيعي

-  Finition texture. Texture finish. Finitura trama. Textur-Finish. Textuur afwerking.  
الانتهاء من المنسج
-  Fermeture ralentie. Soft close. Frenata soft close. Sanfter Verschluss. Zachtsluitend. نظام إغلاق أوتوماتيكي.
-  Organisateur. Organizer unit. Organizzatore. Obere Ablage. Superieure organizer. منظم درج علوي.
-  Façades réglables. Adjustable front. Frontali regolabili. Einstellbare Vorderseite. Verstelbaar front. الدروج الأمامية قابلة للتعديل.
-  Glissières Hettich. Hettich sliding system. Guide Hettich. Korpuschiene Hettich. Hettich lade system. مفصلات الماينة هيتش.
-  Laqué brillant. Glossy lacquered finish. Laccato lucido. Glanzend lackiert. Hoogglans gelakt. لكر لميع.
-  Système anti buée. Anti fog system. Sistema antiappannamento. Anti Beschlag System. نظام ضد الضباب.
-  Réversible. It is reversible. Reversibile. Umkehrbar. Omkeerbaar. ja. استعمال عكسي.
-  Capteurs de infrarouge. Infrared sensor On/Off. Sensore infrarosso On/Off. Infrarot Sensorschalter On/Off. Infrared sensor. حساس بلوتوث انشاء / تشغيل.

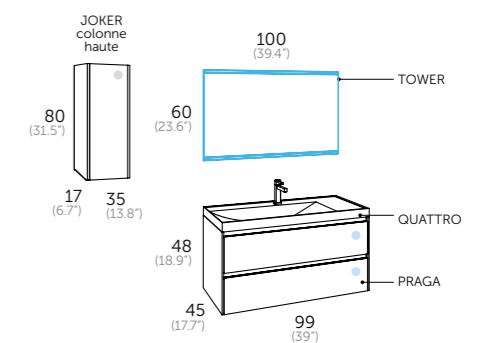

### Composition | blanc brillant

1	162 01 100	<b>Praga 100</b>
1	521 01 100	<b>Quattro</b>
1	262 00 100	<b>Tower</b>

### Auxiliaires

1	137 01 435	<b>Joker colonne haute</b>
---	------------	----------------------------



### Robinet

1	412 00 800	<b>Combi chrome</b>
---	------------	---------------------





# praga.120

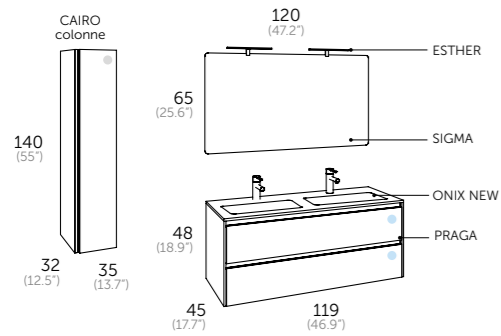

## Composition | chêne naturel

1	162 24 120	<b>Praga 120</b>
1	550 01 122	<b>Onix new 2v.</b>
1	290 00 120	<b>Sigma</b>
2	400 00 121	<b>Esther</b>

## Auxiliaires

1	194 24 335	<b>Cairo colonne</b>
---	------------	----------------------



## Robinet

2	412 00 800	<b>Combi chrome</b>
---	------------	---------------------

Finition texture. Texture finish. Finitura trama. Textur-Finish. Textuur afwerking. الانتهاء من الملمس

Fermeture ralentie. Soft close. Frenata soft close. Sanfter Verschluss. Zachtsluitend. نظام إغلاق أوتوماتيكي

Organisateur. Organizer unit. Organizzatore. Obere Ablage. Superieure organizer. منظم درج علوي

Façades réglables. Adjustable front. Frontali regolabili. Einstellbare Vorderseite. Verstellbaar front. الدروج الامامية قابلة للتعديل

Glissières Hettich. Hettich sliding system. Guide Hettich. Korpuschiene Hettich. Hettich lade system. مفصلات الماينة هيتش

Fermeture ralentie. Soft close. Frenata soft close. Sanfter Verschluss. Zachtsluitend. نظام إغلاق أوتوماتيكي

Melamine structuré. Textured melamine. Melamina testurizzata. Textur mit Relief. Reliefstructuur. ملمس منقوش



- Blanc brillant  
Glossy white  
Blanco lucido  
Weiss hochglanz  
Witte glans  
أبيض قيع لكر
- Chêne naturel  
Natural oak  
Rovere naturale  
Naturele eiken  
Naturel eiken  
بلوط طبيعي
- Pin gris  
Grey pine  
Pino-grigio  
Kiefer grau  
Grijs pijn  
سرو رومادي
- Wenge nature  
بني غامق طبيعي

**praga.60** (23.62")

plan vasque / washbasin / lavabo / waschtisch / wastafels / تروس

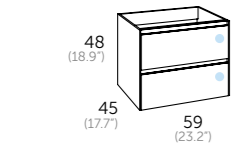

Finition	Référence
○ Blanc brillant	162 01 060
● Chêne naturel	162 24 060
● Pin gris	162 37 060
● Wenge nature	162 44 060

ONIX NEW céramique	TOPACIO résine	QUATTRO céramique	AMBAR mat	MASAI	MASAI plateaux
Référence 550 01 060	Référence 505 01 060	Référence 521 01 060	Référence 506 01 060	Référence ○ Blanc 518 01 060 ● Noir 518 02 060 Plus de couleurs à la page 284	Référence ○ Blanc 519 01 060 ● Noir 519 02 060 Plus de couleurs à la page 286

**praga.70** (27.55")

plan vasque / washbasin / lavabo / waschtisch / wastafels / تروس

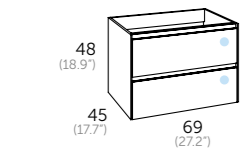

Finition	Référence
○ Blanc brillant	162 01 070
● Chêne naturel	162 24 070
● Pin gris	162 37 070
● Wenge nature	162 44 070

ONIX NEW céramique	AMBAR mat	MASAI	MASAI plateaux	AMBAR plateaux
Référence 550 01 070	Référence 506 01 070	Référence ○ Blanc 518 01 070 ● Noir 518 02 070 Plus de couleurs à la page 284	Référence ○ Blanc 519 01 070 ● Noir 519 02 070 Plus de couleurs à la page 286	Référence 508 01 070

**praga.80** (31.49")

plan vasque / washbasin / lavabo / waschtisch / wastafels / تروس

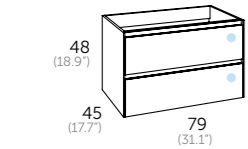

Finition	Référence
○ Blanc brillant	162 01 080
● Chêne naturel	162 24 080
● Pin gris	162 37 080
● Wenge nature	162 44 080

ONIX NEW céramique	TOPACIO résine	QUATTRO céramique	AMBAR mat	MASAI	MASAI plateaux
Référence 550 01 080	Référence 505 01 080	Référence 521 01 080	Référence 506 01 080	Référence ○ Blanc 518 01 080 ● Noir 518 02 080 Plus de couleurs à la page 284	Référence ○ Blanc 519 01 080 ● Noir 519 02 080 Plus de couleurs à la page 286

**praga.100** (39.37")

plan vasque / washbasin / lavabo / waschtisch / wastafels / تروس

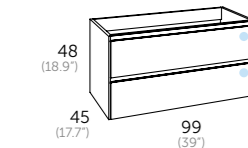

Finition	Référence
○ Blanc brillant	162 01 100
● Chêne naturel	162 24 100
● Pin gris	162 37 100
● Wenge nature	162 44 100

ONIX NEW céramique	TOPACIO résine	QUATTRO céramique	AMBAR mat	MASAI	MASAI plateaux
Référence 550 01 100	Référence 505 01 100	Référence 521 01 100	Référence 506 01 100	Référence ○ Blanc 518 01 100 ● Noir 518 02 100 Plus de couleurs à la page 284	Référence ○ Blanc 519 01 100 ● Noir 519 02 100 Plus de couleurs à la page 286

**praga.120** (47.24")

plan vasque / washbasin / lavabo / waschtisch / wastafels / تروس

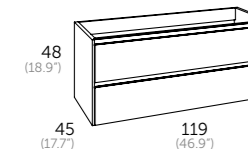

Finition	Référence
○ Blanc brillant	162 01 120
● Chêne naturel	162 24 120
● Pin gris	162 37 120
● Wenge nature	162 44 120

ONIX NEW céramique	TOPACIO résine	AMBAR mat	AMBAR décalé	MASAI	MASAI plateaux
Référence 550 01 122	Référence 505 01 122	Référence 506 01 122	Référence Gauche 506 01 121 Droite 506 01 123	Référence ○ Blanc 518 01 122 ● Noir 518 02 122 Plus de couleurs à la page 284	Référence ○ Blanc 519 01 120 ● Noir 519 02 120 Plus de couleurs à la page 286

**landes.plateaux**

avec barre de renfort en aluminium

	Chêne naturel	Pin Gris
60	112 24 206	112 37 206
70	112 24 207	112 37 207
80	112 24 208	112 37 208
100	112 24 210	112 37 210
120	112 24 212	112 37 212

vasque à poser / over countertop basins

ROTTERDAM	ESTAMBUL	SEI	OVAL
Référence 507 01 004	Référence 507 01 005	Référence 530 01 006	Référence 509 01 001

miroirs / mirrors / specchio / spiegel / spiegels / مرايا

PLAN VASQUES ET MIROIRS PLUS D'OPTIONS DANS LES PAGES 280 - 299

SUN	ROND	RAIN led	VERONA led	VERONA rond led	MÓDENA led	FLASH 60	SKYLINE 60
Référence 204 00 060	Référence 244 00 060	Référence 269 00 060	Référence 246 00 060	Référence 247 00 070	Référence 264 00 080	Référence Aluminium 340 11 060	Référence ○ Blanc brillant 341 01 060 ● Chêne naturel 341 24 060

miroirs / mirrors / specchio / spiegel / spiegels / مرايا

SUN	ROND	RAIN led	VERONA led	VERONA rond led	FLASH 70
Référence 204 00 070	Référence 244 00 070	Référence 269 00 070	Référence 246 00 070	Référence 247 00 070	Référence Aluminium 340 11 070

miroirs / mirrors / specchio / spiegel / spiegels / مرايا

SUN	SIGMA	RAIN led	VERONA led	VERONA rond led	COSMOS led	SPOTY led	FLASH 80
Référence 204 00 080	Référence 290 00 080	Référence 269 00 080	Référence 246 00 100	Référence 247 00 080	Référence 270 00 080	Référence 267 00 080	Référence Aluminium 340 11 080

miroirs / mirrors / specchio / spiegel / spiegels / مرايا

SUN	SIGMA	RAIN led	VERONA led	VERONA rond led	COSMOS led	TOWER led	SPOTY led
Référence 204 00 100	Référence 290 00 100	Référence 269 00 100	Référence 246 00 100	Référence 247 00 100	Référence 270 00 100	Référence 262 00 100	Référence 267 00 100

**auxiliaires / auxiliary units**

**cairo.colonne**

Finition	Référence
○ Blanc brillant	194 01 335
● Chêne naturel	194 24 335
● Pin gris	194 37 335
● Wenge nature	194 44 335

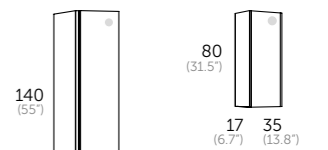

Ouverture réversible | Reversible opening

**joker.colonne haute**

Finition	Référence
○ Blanc brillant	137 01 435
● Chêne naturel	137 24 435
● Pin gris	137 37 435
● Wenge nature	137 44 435



Ouverture réversible | Reversible opening

**joker.auxiliaire**

Finition	Référence
○ Blanc brillant	137 01 445
● Chêne naturel	137 24 445
● Pin gris	137 37 445
● Wenge nature	137 44 445



Ouverture réversible | Reversible opening

pieds / legs

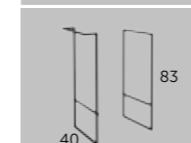

Kit Industrial (Réversible)

Pour meuble 48 cm hauteur

● Noir	412 02 715	135
--------	------------	-----



● Chrome  
412 00 800  
Plus de couleurs à la page 291





# hole.

80 / 90 / 100





Chêne naturel  
Natural oak  
Rovere naturale  
Naturele eiken  
بلوط طبيعي

Pin gris  
Grey pine  
Pino-grigio  
Kiefer grau  
Grijs pijn  
سرو رمادي



## hole.90



Finition texture. Texture finish. Finitura trama. Textur-Finish. Textuur afwerking. الانتهاء من الملمس



Fermeture ralentie. Soft close. Frenata soft close. Sanfter Verschluss. Zachtsluitend. نظام إغلاق أوتوماتيكي.



Organisateur. Organizer unit. Organizzatore. Obere Ablage. Superieure organizer. منظم درج علوي.



Façades réglables. Adjustable front. Frontail réglabili. Einstellbare Vorderseite. Verstelbaar front. الدروج الامامية قابلة للتعديل.



Glissières Hettich. Hettich sliding system. Guide Hettich. Korpussschiene Hettich. Hettich lade system. مفصلات المانية هيتش.



Fermeture ralentie. Soft close. Frenata soft close. Sanfter Verschluss. Zachtsluitend. نظام إغلاق أوتوماتيكي.



Mélamine structurée. Textured melamine. Melamina testurizzata. Textur mit Relief. Reliefstructuur. ملمس منقوش.

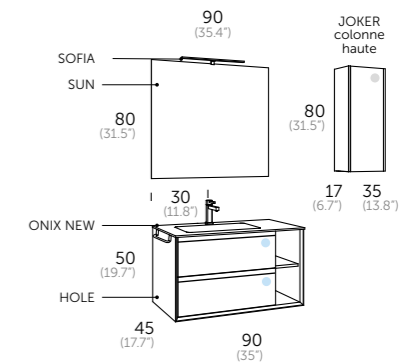

Composition | chêne naturel

1	132 24 090	<b>Hole 90</b>
1	550 01 091	<b>Onix new 70+20 (gauche)</b>
1	204 00 090	<b>Sun</b>
1	400 00 141	<b>Sofia</b>

Auxiliaires

1	137 24 435	<b>Joker colonne haute</b>
1	416 00 001	<b>Porte-serviettes</b>



Robinet

1	412 24 800	<b>Combi / chêne naturel</b>
---	------------	------------------------------



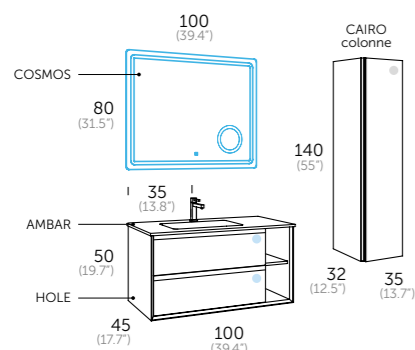

## Composition | pin gris

1	132 37 100	<b>Hole 100</b>
1	506 01 107	<b>Ambar 70+30 (gauche)</b>
1	270 00 100	<b>Cosmos</b>

## Auxiliaires

1	194 37 335	<b>Cairo colonne</b>
---	------------	----------------------

## Robinet

1	412 00 800	<b>Combi chrome</b>
---	------------	---------------------

Finition texture. Texture finish. Finitura trama. Textur-Finish. Textuur afwerking. الانتهاء من الملمس

Fermeture ralentie. Soft close. Frenata soft close. Sanfter Verschluss. Zachtsluitend. نظام إغلاق أوتوماتيكي

Organisateur. Organizer unit. Organizzatore. Obere Ablage. Superieure organizer. منظم درج علوي

Façades réglables. Adjustable front. Frontali regolabili. Einstellbare Vorderseite. Verstellbaar front. الدرج الامامية قابلة للتعديل

Glissières Hettich. Hettich sliding system. Guide Hettich. Korpuschiene Hettich. Hettich lade system. مفصلات المانتيهتيش

Mèlamine structuré. Textured melamine. Melamina testurizzata. Textur mit Relief. Reliefstructuur. ملمس منقوش

Système anti buée. Anti fog system. Sistema antiappannamento. Anti Beschlag System. نظام ضد الضباب

Capteurs de contact. Contact sensor On/Off. Sensore di con tatto On/Off. Sensorschalter On/Off. Aanraken Schakelaar. حساس لمس اطفاء / تشغيل

Miroir loupe 3x éclairé. Magnifying zoom in Mirror. Lente d'ingrandimento 3x. Lupe 3x Vergrößerung. Verrootglas: verhoging x 3. مكبرة 3 أضعاف

## hole.100

Chêne naturel  
Natural oak  
Rovere naturale  
Natuurle eiken  
بلوط طبيعي

Pin gris  
Grey pine  
Pino-grigio  
Kiefer grau  
Grijs pijn  
سرو رمادي



Finition texture. Texture finish. Finitura trama. Textur-Finish. Textuur afwerking. الانتهاء من الملمس

Fermeture ralentie. Soft close. Frenata soft close. Sanfter Verschluss. Zachtsluitend. نظام إغلاق أوتوماتيكي

Organisateur. Organizer unit. Organizzatore. Obere Ablage. Superieure organizer. منظم درج علوي

Façades réglables. Adjustable front. Frontali regolabili. Einstellbare Vorderseite. Verstellbaar front. الدرج الامامية قابلة للتعديل

Glissières Hettich. Hettich sliding system. Guide Hettich. Korpuschiene Hettich. Hettich lade system. مفصلات المانتيهتيش

Fermeture ralentie. Soft close. Frenata soft close. Sanfter Verschluss. Zachtsluitend. نظام إغلاق أوتوماتيكي

Mèlamine structuré. Textured melamine. Melamina testurizzata. Textur mit Relief. Reliefstructuur. ملمس منقوش

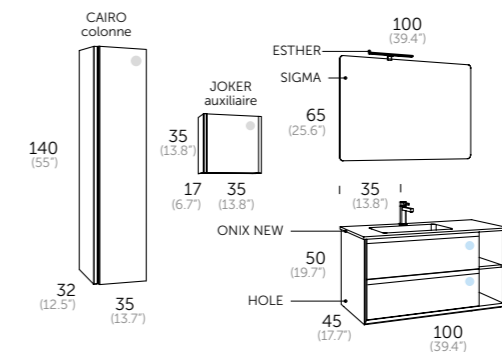

## Composition | chêne naturel

1	132 24 100	<b>Hole 100</b>
1	550 01 101	<b>Onix new 70+30 (gauche)</b>
1	290 00 100	<b>Sigma</b>
1	400 00 121	<b>Esther</b>

## Auxiliaires

1	194 24 335	<b>Cairo colonne</b>
1	137 24 445	<b>Joker auxiliaire</b>

## Robinet

1	412 00 800	<b>Combi chrome</b>
---	------------	---------------------

## hole.80 (31.49")

plan vasque / washbasin / lavabo / waschtisch / wastafels / تروس

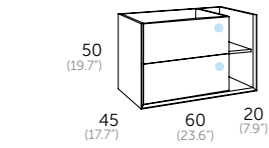

Finition	Référence
● Chêne naturel	132 24 080
● Pin gris	132 37 080

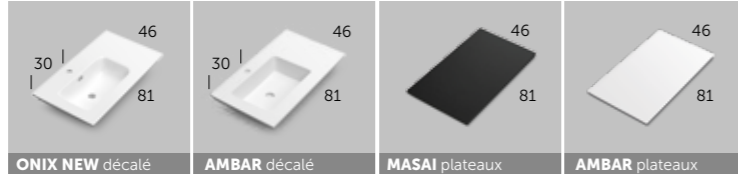

ONIX NEW décalé	AMBAR décalé	MASAI plateau	AMBAR plateau
Référence Gauche (60 + 20) <b>550 01 081</b>	Référence Gauche (60 + 20) <b>506 01 081</b>	Référence ○ Blanc <b>519 01 080</b> ● Noir <b>519 02 080</b> Plus de couleurs à la page 286	Référence <b>508 01 080</b>

miroirs / mirrors / specchio / spiegel / spiegels / مرايا

PLAN VASQUES ET MIROIRS PLUS D'OPTIONS DANS LES PAGES 280 - 299



SUN	SIGMA	RAIN led	VERONA led	VERONA rond led	TOWER led	COSMOS led	FLASH 80 armoire
Référence <b>204 00 080</b>	Référence <b>290 00 080</b>	Référence <b>269 00 080</b>	Référence <b>246 00 100</b>	Référence <b>247 00 080</b>	Référence <b>262 00 080</b>	Référence <b>270 00 080</b>	Référence Aluminium <b>340 11 080</b>

## hole.90 (35.43")

plan vasque / washbasin / lavabo / waschtisch / wastafels / تروس

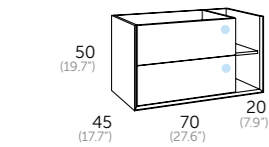

Finition	Référence
● Chêne naturel	132 24 090
● Pin gris	132 37 090

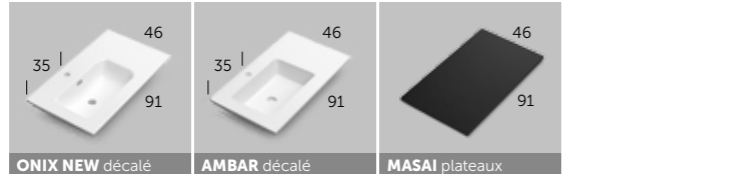

ONIX NEW décalé	AMBAR décalé	MASAI plateau
Référence Gauche (70 + 20) <b>550 01 091</b>	Référence Gauche (70 + 20) <b>506 01 092</b>	Référence ○ Blanc <b>519 01 090</b> ● Noir <b>519 02 090</b> Plus de couleurs à la page 286

miroirs / mirrors / specchio / spiegel / spiegels / مرايا

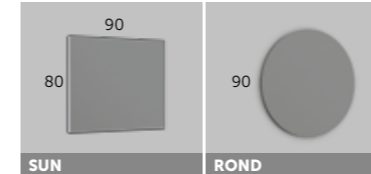

SUN	ROND
Référence <b>204 00 090</b>	Référence <b>244 00 090</b>

## hole.100 (39.37")

plan vasque / washbasin / lavabo / waschtisch / wastafels / تروس

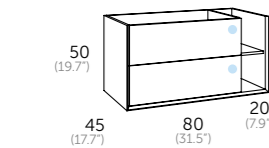

Finition	Référence
● Chêne naturel	132 24 100
● Pin gris	132 37 100

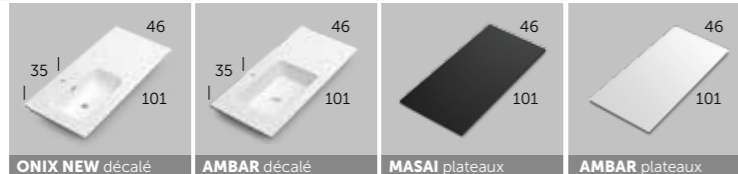

ONIX NEW décalé	AMBAR décalé	MASAI plateau	AMBAR plateau
Référence Gauche (70 + 30) <b>550 01 101</b>	Référence Gauche (70 + 30) <b>506 01 107</b>	Référence ○ Blanc <b>519 01 100</b> ● Noir <b>519 02 100</b> Plus de couleurs à la page 286	Référence <b>508 01 100</b>

miroirs / mirrors / specchio / spiegel / spiegels / مرايا



SUN	SIGMA	RAIN led	VERONA led	VERONA rond led	TOWER led	COSMOS led	SPOTY led
Référence <b>204 00 100</b>	Référence <b>290 00 100</b>	Référence <b>269 00 100</b>	Référence <b>246 00 100</b>	Référence <b>247 00 100</b>	Référence <b>262 00 100</b>	Référence <b>270 00 100</b>	Référence <b>267 00 100</b>

## auxiliaires / auxiliary units

### cairo.colonne

Finition	Référence
● Chêne naturel	194 24 335
● Pin gris	194 37 335

Ouverture réversible | Reversible opening

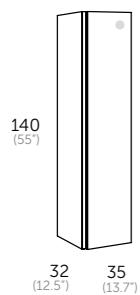

### joker.colonne haute

Finition	Référence
● Chêne naturel	137 24 435
● Pin gris	137 37 435

Ouverture réversible | Reversible opening

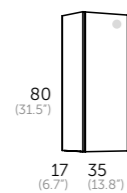

### joker.auxiliaire

Finition	Référence
● Chêne naturel	137 24 445
● Pin gris	137 37 445

Ouverture réversible | Reversible opening

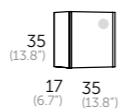

## pieds / legs

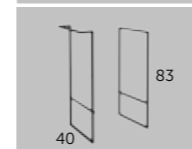

**Kit Industrial** (Reversible)  
Pour meuble 48 cm hauteur

● Noir  
**412 02 715**

## landes.plateaux

vasque à poser / over countertop basins

avec barre de renfort en aluminium

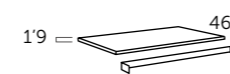

	Chêne naturel	Pin Gris
80	112 24 208	112 37 208
90	112 24 209	112 37 209
100	112 24 210	112 37 210

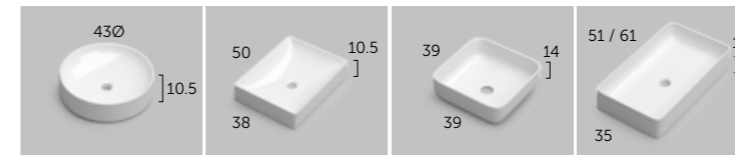

ROTTERDAM	ESTAMBUL	SEI	TRE
Référence <b>507 01 004</b>	Référence <b>507 01 005</b>	Référence <b>530 01 006</b>	Référence 51 / 61 <b>530 01 035</b> 61 / 530 01 036



**UNIV. CLIC CLAC** Valve

Référence Prix  
● Chrome  
**410 00 203**  
Plus de couleurs à la page 330



**COMBI** Robinet

Référence Prix  
● Chrome  
**412 00 800**  
Plus de couleurs à la page 291

## éclairage / spotlights



NEREA MAT	ESTHER 30	SOFIA 60
Référence Lumière froide 6000k <b>400 14 161</b>	Référence Lumière froide 6000k <b>400 00 121</b>	Référence Lumière froide 6000k <b>400 00 141</b>





# **galsaky.**

60 / 70 / 80 / 100





## galsaky.60

Composition | gris brillant

1	151 03 060	<b>Galsaky 60</b>
1	550 01 060	<b>Onix new</b>
1	269 00 060	<b>Rain 60</b>

Auxiliaires

2	137 03 445	<b>Joker auxiliaire</b>
---	------------	-------------------------



Robinet

1	412 00 800	<b>Combi chrome</b>
---	------------	---------------------

Finition texture. Texture finish. Finitura trama. Textur-Finish. Textuur afwerking. الانتهاء من الملمس

Organisateur. Organizer unit. Organizzatore. Obere Ablage. Superieure organizer. منظم درج علوي

Fermeture ralentie. Soft close. Frenata soft close. Sanfter Verschluss. Zachtsluitend. نظام إغلاق أوتوماتيكي

Façades réglables. Adjustable front. Frontali regolabili. Einstellbare Vorderseite. Verstellbaar front. الدروج الامامية قابلة للتعديل

Glissières Hettich. Hettich sliding system. Guide Hettich. Korpussschiene Hettich. Hettich lade system. مفصلات المانبة هيتش

Fermeture ralentie. Soft close. Frenata soft close. Sanfter Verschluss. Zachtsluitend. نظام إغلاق أوتوماتيكي

Laquéé brillant. Glossy lacquered finish. Laccato lucido. Glanzend lackiert. Hoogglans gelakt. لكر لميع

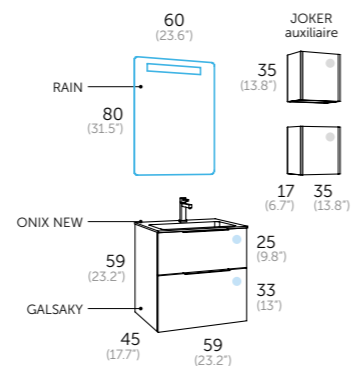

## galsaky.70

Blanc brillant  
Glossy white  
Bianco lucido  
Weiss hochglanz  
Witte glans  
أبيض لميع لكر

Gris brillant  
Glossy grey  
Grigio lucido  
Grau hochglanz  
Grijs glans  
رمادي لميع لكر

Chêne naturel  
Natural oak  
Rovere naturale  
Naturele eiken  
بلوط طبيعي

Pin gris  
Grey pine  
Pino-grigio  
Kiefer grau  
Grijs pijn  
سرو رمادي

Noyer  
Dark walnut  
Noce  
Walnuss  
Walnoot  
خشبي جوزي

Finition texture. Texture finish. Finitura trama. Textur-Finish. Textuur afwerking. الانتهاء من الملمس

Organisateur. Organizer unit. Organizzatore. Obere Ablage. Superieure organizer. منظم درج علوي

Fermeture ralentie. Soft close. Frenata soft close. Sanfter Verschluss. Zachtsluitend. نظام إغلاق أوتوماتيكي

Façades réglables. Adjustable front. Frontali regolabili. Einstellbare Vorderseite. Verstellbaar front. الدروج الامامية قابلة للتعديل

Glissières Hettich. Hettich sliding system. Guide Hettich. Korpussschiene Hettich. Hettich lade system. مفصلات المانبة هيتش

Fermeture ralentie. Soft close. Frenata soft close. Sanfter Verschluss. Zachtsluitend. نظام إغلاق أوتوماتيكي

Mélangé structuré. Textured melamine. Melamina testurizzata. Textur mit Relief. Reliefstructuur. ملمس منقوش

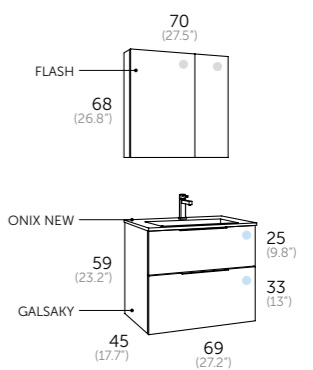

Composition | noyer

1	151 39 070	<b>Galsaky 70</b>
1	550 01 070	<b>Onix new</b>
1	340 11 070	<b>Flash</b>



Robinet

1	412 00 800	<b>Combi chrome</b>
---	------------	---------------------





# galsaky.80

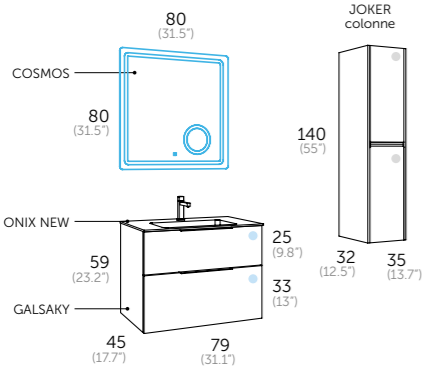

## Composition | chêne naturel

1	151 24 080	<b>Galsaky 80</b>
1	550 01 080	<b>Onix new</b>
1	270 00 080	<b>Cosmos</b>

## Auxiliaires

1	137 24 335	<b>Joker colonne</b>
---	------------	----------------------



## Robinet

1	412 24 800	<b>Combi / chêne naturel</b>
---	------------	------------------------------

Blanc brillant Glossy white Bianco lucido Weiss hochglanz Witte glans أبيض لمع لكر	Gris brillant Glossy grey Grigio lucido Grau hochglanz Grijs glans رمادي لمع لكر	Chêne naturel Natural oak Rovere naturale Natureiche Naturel eiken بلوط طبيعي

Pin gris Grey pine Pino-grigio Kiefer grau Grijs pijn سرو رمادي	Noyer Dark walnut Noce Walnuss Walnoot خشبي جوزي



option avec pieds Kuadro  
+ poignées noires  
+ porte-serviettes noir

- Finition texture. Texture finish. Finitura trama. Textur-Finish. Textuur afwerking. الاتيه من الخشب
- Organisateur. Organizer unit. Organizzatore. Obere Ablage. Superiore organizer. منظم درج علوي
- Fermeture ralentie. Soft close. Frenata soft close. Sanfter Verschluss. Zachtsluitend. نظام إغلاق انوماتيكي
- Façades réglables. Adjustable front. Frontali regolabili. Einstellbare Vorderseite. Verstelbaar front. الدرّوج الامامية قابلة للتعديل
- Glissières Hettich. Hettich sliding system. Guide Hettich. Korpuschiene Hettich. Hettich lade system. مفصلات المانيّة هيتش
- Melamine structuré. Textured melamine. Melamina testurizzata. Textur mit Relief. Reliefstructuur. ملمس منقوش
- Système anti buée. Anti fog system. Sistema antiappannamento. Anti Beschlag System. نظام ضد الضباب
- Capteurs de contact. Contact sensor On/Off. Sensore di con tatto On/Off. Sensorschalter On/Off. Aanraken Schakelaar. حساس لمس اطفاء / تشغيل
- Miroir loupe 3x éclairé. Magnifying zoom in Mirror. Lente d'ingrandimento 3x. Lupe 3x Vergrößerung. Vergrootglas: verhoging x3. مكبرية 3 أضعاف





Blanc brillant  
Glossy white  
Bianco lucido  
Weiss hochglanz  
Witte glans  
أبيض لمع لكر



Gris brillant  
Glossy grey  
Grigio lucido  
Grau hochglanz  
Grijs glans  
رمادي لمع لكر



Chêne naturel  
Natural oak  
Rovere naturale  
Natureiche  
Naturel eiken  
بلوط طبيعي



Pin gris  
Grey pine  
Pino-grigio  
Kiefer grau  
Grijs pijn  
سرو رمادي



Noyer  
Dark walnut  
Noce  
Walnuss  
Walnoot  
خشبي جوزي

## galsaky.100



Finition texture. Texture finish. Finitura trama. Textur-Finish. Textuur afwerking.  
الانتهاء من الملمس



Organisateur. Organizer unit.  
Organizzatore. Obere Ablage.  
Superieure organizer. منظم درج علوي.  
نظام إبقاء اتوماتيكي



Fermeture ralentie. Soft close.  
Frenata soft close. Sanfter Verschluss.  
Zachtsluitend. نظام إبقاء اتوماتيكي



Façades réglables. Adjustable front.  
Frontali regolabili. Einstellbare Vorderseite. Verstelbaar front.  
الدروج الأمامية قابلة للتعديل



Glissières Hettich. Hettich sliding system. Guide Hettich. Korpussschiene Hettich. Hettich lade system.  
مفصلات الجانبيه هيتش



Fermeture ralentie. Soft close.  
Frenata soft close. Sanfter Verschluss.  
Zachtsluitend. نظام إبقاء اتوماتيكي



Laqué brillant. Glossy lacquered finish.  
Lacato lucido. Glänzend lackiert.  
Hoogglans gelakt. لكر لمع



Système anti buée. Anti fog system.  
Sistema antiappannamento.  
Anti Beschlag System.  
نظام ضد الضباب



Lumière ambiante. Ambient light.  
Luce ambiente. Ambient Light.  
إضاءة خلفية



Capteurs de contact. Contact sensor On/Off. Sensore di con tatto On/Off.  
Sensorschalter On/Off. Aanraken Schakelaar. حساس لمس إطفاء / تشغيل



Réversible. It is reversible. Reversibile.  
Umkehrbar. Omkeerbaar. ja استعمال عكسي

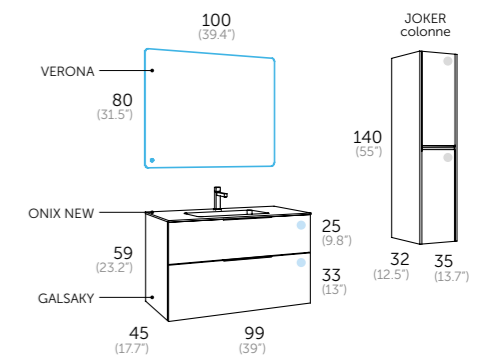

### Composition | blanc brillant

1	151 01 100	<b>Galsaky 100</b>
1	550 01 100	<b>Onix new</b>
1	246 00 100	<b>Verona</b>

### Auxiliaires

1	137 01 335	<b>Joker colonne</b>
---	------------	----------------------



1	412 00 800	<b>Combi chrome</b>
---	------------	---------------------





# galsaky.120



option poignées noires

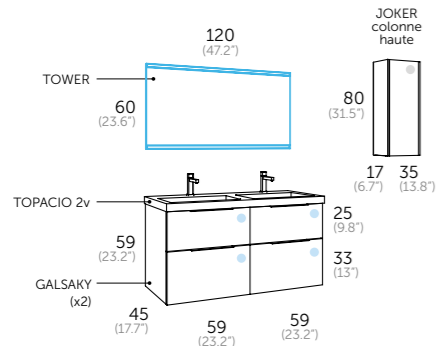

Composition | blanc brillant

2	151 01 060	<b>Galsaky 60</b>
1	505 01 122	<b>Topacio 2v.</b>
1	262 00 120	<b>Tower</b>

Auxiliaires

1	137 01 435	<b>Joker colonne haute</b>
---	------------	----------------------------

Robinet

2	412 00 800	<b>Combi chrome</b>
---	------------	---------------------

Finition texture. Texture finish. Finitura trama. Textur-Finish. Textuur afwerking. الانتهاء من الملمس

Organisateur. Organizer unit. Organizzatore. Obere Ablage. Superieure organizer. منظم درج علوي

Fermeture ralentie. Soft close. Frenata soft close. Sanfter Verschluss. Zachtsluitend. نظام إغلاق أوتوماتيكي

Façades réglables. Adjustable front. Frontali regolabili. Einstellbare Vorderseite. Verstelbaar front. الدروج الامامية قابلة للتعديل

Glissières Hettich. Hettich sliding system. Guide Hettich. Körperschiene Hettich. Hettich lade system. مفصلات الجانبيتهتيش

Laquée brillant. Glossy lacquered finish. Laccato lucido. Glänzend lackiert. Hoogglans gelakt. لكر لميع

Système anti buée. Anti fog system. Sistema antiappannamento. Anti Beschlag System. Spiegelverwarming. نظام ضد الضباب

Capteurs de infrarouge. Infrared sensor On/Off. Sensore infrarosso On/Off. Infrarot Sensorschalter On/Off. Infrarood sensor. حساس بلونوت انفااء / تشغيل

Réversible. It is reversible. Reversibile. Umkehrbar. Omkeerbaar: ja استعمال عكسي



- Blanc brillant  
Glossy white  
Bianco lucido  
Weiss hochglanz  
Witte glans  
أبيض لميع لكر
- Gris brillant  
Glossy grey  
Grigio lucido  
Grau hochglanz  
Grijs glans  
رمادي لميع لكر
- Chêne naturel  
Natural oak  
Rovere naturale  
Natureiche  
Naturele eiken  
بلوط طبيعي
- Pin gris  
Grey pine  
Pino-grigio  
Kiefer grau  
Grijs pijn  
سرو رمادي
- Noyer  
Dark walnut  
Noce  
Walnuss  
Walnoot  
خشبي جوزي





# galsaky.140

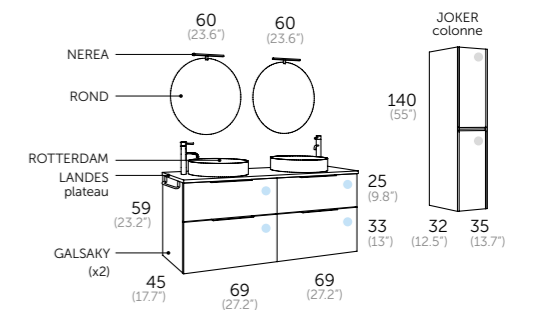

## Composition | pin gris

2	151 37 070	<b>Galsaky 70</b>
1	112 37 214	<b>Landes plateau 140</b>
2	507 01 004	<b>Rotterdam</b>
2	244 00 060	<b>Rond</b>
2	400 14 161	<b>Nerea</b>

## Auxiliaires

1	137 37 335	<b>Joker colonne</b>
1	416 00 001	<b>Porte-serviettes</b>



Blanc brillant Glossy white Bianco lucido Weiss hochglanz Witte glans أبيض لميع لكر	Gris brillant Glossy grey Grigio lucido Grau hochglanz Grijs glans رمادي لميع لكر	Chêne naturel Natural oak Rovere naturale Naturele eiken بلوط طبيعي

Pin gris Grey pine Pino-grigio Kiefer grau Grijs pijn سرو رمادي	Noyer Dark walnut Noce Walnuss Walnoot خشبي جوزي

- Finition texture. Texture finish. Finitura trama. Textur-Finish. Textuur afwerking. الانتهاء من الملمس
- Organisateur. Organizer unit. Organizzatore. Obere Ablage. Superieure organizer. منظم درج علوي
- Fermeture ralentie. Soft close. Frenata soft close. Sanfter Verschluss. Zachtsluitend. نظام إغلاق اوماتيكي
- Façades réglables. Adjustable front. Frontali regolabili. Einstellbare Vorderseite. Verstelbaar front. الدروج الامامية قابلة للتعديل
- Glissières Hettich. Hettich sliding system. Guide Hettich. Korpuschiene Hettich. Hettich lade system. مفصلات الماتيهيتش
- Fermeture ralentie. Soft close. Frenata soft close. Sanfter Verschluss. Zachtsluitend. نظام إغلاق اوماتيكي
- Mélangé structuré. Textured melamine. Melamina testurizzata. Textur mit Relief. Reliefstructuur. ملمس منقوش



## galsaky.60 (23.62")

plan vasque / washbasin / lavabo / waschtisch / wastafels / تروس

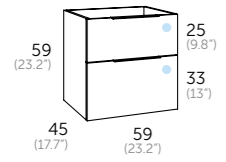

○ Blanc brillant	151 01 060
● Gris brillant	151 03 060
● Chêne naturel	151 24 060
● Pin gris	151 37 060
● Noyer	151 39 060

<b>ONIX NEW</b> céramique	<b>TOPACIO</b> resine	<b>QUATTRO</b> céramique	<b>AMBAR</b> mat	<b>MASAI</b>
Référence 550 01 060	Référence 505 01 060	Référence 521 01 060	Référence 506 01 060	Référence ○ Blanc 518 01 060 ● Noir 518 02 060 Plus de couleurs à la page 284

miroirs / mirrors / specchio / spiegel / spiegels / مرآيا

PLAN VASQUES ET MIROIRS PLUS D'OPTIONS DANS LES PAGES 280 - 299

<b>SUN</b>	<b>ROND</b>	<b>RAIN</b> led	<b>VERONA</b> led	<b>VERONA</b> rond led	<b>MÓDENA</b> led	<b>FLASH 60</b>	<b>SKYLINE 60</b> armoire
Référence 204 00 060	Référence 244 00 060	Référence 269 00 060	Référence 246 00 060	Référence 247 00 070	Référence 264 00 080	Référence Aluminium 340 11 060	Référence ○ Blanc brillant 341 01 060 ● Chêne naturel 341 24 060

## galsaky.70 (27.55")

plan vasque / washbasin / lavabo / waschtisch / wastafels / تروس

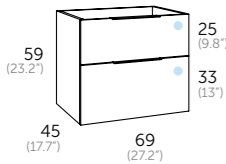

○ Blanc brillant	151 01 070
● Gris brillant	151 03 070
● Chêne naturel	151 24 070
● Pin gris	151 37 070
● Noyer	151 39 070

<b>ONIX NEW</b> céramique	<b>AMBAR</b> mat	<b>MASAI</b>	<b>MASAI</b> plateaux	<b>AMBAR</b> plateaux
Référence 550 01 070	Référence 506 01 070	Référence ○ Blanc 518 01 070 ● Noir 518 02 070 Plus de couleurs à la page 284	Référence ○ Blanc 519 01 070 ● Noir 519 02 070 Plus de couleurs à la page 286	Référence 508 01 070

miroirs / mirrors / specchio / spiegel / spiegels / مرآيا

<b>SUN</b>	<b>ROND</b>	<b>RAIN</b> led	<b>VERONA</b> led	<b>VERONA</b> rond led	<b>FLASH 70</b> armoire
Référence 204 00 070	Référence 244 00 070	Référence 269 00 070	Référence 246 00 070	Référence 247 00 070	Référence Aluminium 340 11 070

## galsaky.80 (31.49")

plan vasque / washbasin / lavabo / waschtisch / wastafels / تروس

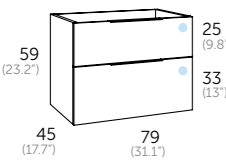

○ Blanc brillant	151 01 080
● Gris brillant	151 03 080
● Chêne naturel	151 24 080
● Pin gris	151 37 080
● Noyer	151 39 080

<b>ONIX NEW</b> céramique	<b>TOPACIO</b> resine	<b>QUATTRO</b> céramique	<b>AMBAR</b> mat	<b>MASAI</b>
Référence 550 01 080	Référence 505 01 080	Référence 521 01 080	Référence 506 01 080	Référence ○ Blanc 518 01 080 ● Noir 518 02 080 Plus de couleurs à la page 284

miroirs / mirrors / specchio / spiegel / spiegels / مرآيا

<b>SUN</b>	<b>SIGMA</b>	<b>RAIN</b> led	<b>VERONA</b> led	<b>VERONA</b> rond led	<b>COSMOS</b> led	<b>SPOTY</b> led	<b>FLASH 80</b> armoire
Référence 204 00 080	Référence 290 00 080	Référence 269 00 080	Référence 246 00 100	Référence 247 00 080	Référence 270 00 080	Référence 267 00 080	Référence Aluminium 340 11 080

## galsaky.100 (39.37")

plan vasque / washbasin / lavabo / waschtisch / wastafels / تروس

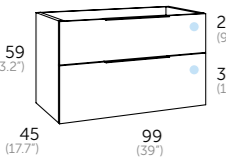

○ Blanc brillant	151 01 100
● Gris brillant	151 03 100
● Chêne naturel	151 24 100
● Pin gris	151 37 100
● Noyer	151 39 100

<b>ONIX NEW</b> céramique	<b>TOPACIO</b> resine	<b>QUATTRO</b> céramique	<b>AMBAR</b> mat	<b>MASAI</b>
Référence 550 01 100	Référence 505 01 100	Référence 521 01 100	Référence 506 01 100	Référence ○ Blanc 518 01 100 ● Noir 518 02 100 Plus de couleurs à la page 284

miroirs / mirrors / specchio / spiegel / spiegels / مرآيا

<b>SUN</b>	<b>SIGMA</b>	<b>RAIN</b> led	<b>VERONA</b> led	<b>VERONA</b> rond led	<b>COSMOS</b> led	<b>TOWER</b> led	<b>SPOTY</b> led
Référence 204 00 100	Référence 290 00 100	Référence 269 00 100	Référence 246 00 100	Référence 247 00 100	Référence 270 00 100	Référence 262 00 100	Référence 267 00 100

## galsaky.120 (60+60) (47.24")

<b>ONIX NEW</b> céramique	<b>TOPACIO</b> resine	<b>SUN</b>	<b>VERONA</b> led
Référence 550 01 122	Référence 505 01 122	Référence 204 00 120	Référence 246 00 120

## galsaky.140 (70+70) (55")

<b>TOPACIO</b> resine	<b>AMBAR</b> mat	<b>SIGMA</b>	<b>VERONA</b> led
Référence 505 01 142	Référence 506 01 142	Référence 290 00 140	Référence 246 00 140

## poignées



Référence  
412 02 730

## landes.plateaux

avec barre de renfort en aluminium

	60	112 24 206	112 37 206
	70	112 24 207	112 37 207
	80	112 24 208	112 37 208
	100	112 24 210	112 37 210
	120	112 24 212	112 37 212
	140	112 24 214	112 37 214

vasque à poser / over countertop basins

<b>ROTTERDAM</b>	<b>ESTAMBUL</b>	<b>SEI</b>
Référence 507 01 004	Référence 507 01 005	Référence 530 01 006

éclairage / spotlights

<b>NEREA MAT</b>	<b>ESTHER 30</b>	<b>SOFIA 60</b>
Référence Lumière froide 6000k 400 14 161	Référence Lumière froide 6000k 400 00 121	Référence Lumière froide 6000k 400 00 141

## auxiliaires / auxiliary units

### joker.colonne

○ Blanc brillant	137 01 335
● Gris brillant	137 03 335
● Chêne naturel	137 24 335
● Pin gris	137 37 335
● Noyer	137 39 335

Ouverture réversible | Reversible opening

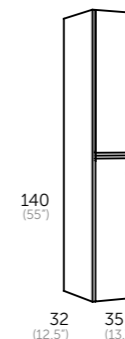

### joker.colonne haute

○ Blanc brillant	137 01 435
● Gris brillant	137 03 435
● Chêne naturel	137 24 435
● Pin gris	137 37 435
● Noyer	137 39 435

Ouverture réversible | Reversible opening

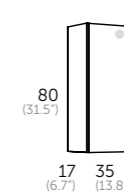

### joker.auxiliaire

○ Blanc brillant	137 01 445
● Gris brillant	137 03 445
● Chêne naturel	137 24 445
● Pin gris	137 37 445
● Noyer	137 39 445

Ouverture réversible | Reversible opening

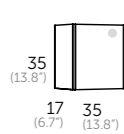



**galsaky.**  
INDUSTRIAL

60 / 70 / 80 / 100 / 120





# galsaky.70

INDUSTRIAL

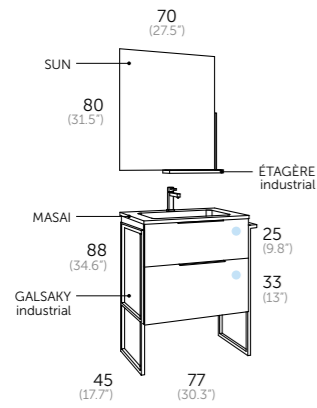

### Composition | pin gris

1	150 37 070	<b>Galsaky IND 70</b>
1	518 02 070	<b>Masai noir</b>
1	204 00 070	<b>Sun</b>

### Auxiliaires

1	412 37 700	<b>Étagère industrial</b>
---	------------	---------------------------



### Robinet

1	412 02 800	<b>Combi noir</b>
---	------------	-------------------

Finition texture. Texture finish. Finitura trama. Textur-Finish. Textuur afwerking. الانتهاء من الختمس

Organisateur. Organizer unit. Organizzatore. Obere Ablage. Superieure organizer. منظم درج علوي

Fermeture ralentie. Soft close. Frenata soft dose. Sanfter Verschluss. Zachtsluitend. نظام إغلاق انوماتيكي

Façades réglables. Adjustable front. Frontali regolabili. Einstellbare Vorderseite. Verstelbaar front. الدروج الامامية قابلة للتعديل

Glissières Hettich. Hettich sliding system. Guide Hettich. Korpuschiene Hettich. Hettich lade system. مفصلات الجانبيهتتش

Melamine structuré. Textured melamine. Melamina testurizzata. Textur mit Relief. Reliefstructuur. ملمس منقوش



# galsaky.60

INDUSTRIAL

- Blanc brillant  
Glossy white  
Bianco lucido  
Weiss hochglanz  
Grijs glans  
أبيض لميع لكر
- Gris brillant  
Glossy grey  
Grigio lucido  
Grau hochglanz  
Grijs glanz  
رمادي لميع لكر
- Chêne naturel  
Natural oak  
Rovere naturale  
Natureiche  
Naturele eiken  
بلوط طبيعي
- Pin gris  
Grey pine  
Pino-grigio  
Kiefer grau  
Grijs pijn  
سرو رمادي
- Noyer  
Dark walnut  
Noce  
Walnuss  
Walnoot  
خشبي جوزي





## galsaky.80

INDUSTRIAL



Blanc brillant  
Glossy white  
Bianco lucido  
Weiss hochglanz  
Witte glans  
أبيض لمع لكر



Gris brillant  
Glossy grey  
Grigio lucido  
Grau hochglanz  
Grijs glans  
رمادي لمع لكر



Chêne naturel  
Natural oak  
Rovere naturale  
Natureiche  
Naturel eiken  
بلوط طبيعي



Pin gris  
Grey pine  
Pino-grigio  
Kiefer grau  
Grijs pijn  
سرو رمادي



Noyer  
Dark walnut  
Noce  
Walnuss  
Walnoot  
خشبي جوزي



Finition texture. Texture finish. Finitura trama. Textur-Finish. Textuur afwerking.  
الانتهاء من الختمس



Organisateur. Organizer unit.  
Organizzatore. Obere Ablage.  
Superieure organizer. منظم درج علوي.



Fermeture ralentie. Soft close.  
Frenata soft close. Sanfter Verschluss.  
Zachtsluitend. نظام إغلاق انوماتيكي.



Façades réglables. Adjustable front.  
Frontali regolabili. Einstellbare Vorderseite. Verstelbaar front.  
الدروع الامامية قابلة للتعديل



Glissières Hettich. Hettich sliding system. Guide Hettich. Korpussschiene Hettich. Hettich lade system.  
مفصلات المانية هيتش



Mélamine structurée. Textured melamine. Melamina testurizzata. Textur mit Relief. Reliefstructuur. ملمس متقوش

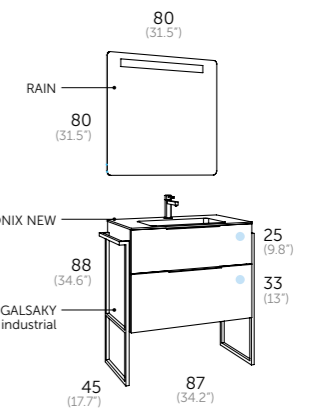

Composition | chêne naturel

1 150 24 080 **Galsaky IND 80**

1 550 01 080 **Onix new**

1 269 00 080 **Rain**



Robinet

1 412 02 800 **Combi noir**



# galsaky.100

INDUSTRIAL

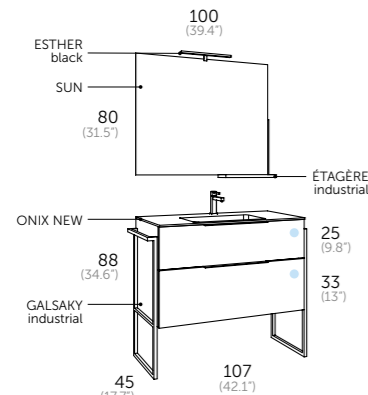

### Composition | noyer

1	150 39 100	<b>Galsaky IND 100</b>
1	550 01 100	<b>Onix new</b>
1	204 00 100	<b>Sun</b>
1	400 02 191	<b>Esther black 45</b>

### Auxiliaires

1	412 39 700	<b>Étagère industrial</b>
---	------------	---------------------------

### Robinet

1	412 02 800	<b>Combi noir</b>
---	------------	-------------------

Finition texture. Texture finish. Finitura trama. Textur-Finish. Textuur afwerking. الانتهاء من الملمس

Organisateur. Organizer unit. Organizzatore. Obere Ablage. Superieure organizer. منظم درج علوي

Fermeture ralentie. Soft close. Frenata soft close. Sanfter Verschluss. Zachtsluitend. نظام إغلاق أوتوماتيكي

Façades réglables. Adjustable front. Frontali regolabili. Einstellbare Vorderseite. Verstelbaar front. الدروج الأمامية قابلة للتعديل

Glissières Hettich. Hettich sliding system. Guide Hettich. Körperschiene Hettich. Hettich lade system. مفصلات الماتية-هتيتش

Mélangine structuré. Textured melamine. Melamina testurizzata. Textur mit Relief. Reliefstructuur. ملمس منقوش



Blanc brillant  
Glossy white  
Bianco lucido  
Weiss hochglanz  
Witte glans  
أبيض لمع لكر



Gris brillant  
Glossy grey  
Grigio lucido  
Grau hochglanz  
Grijs glans  
رمادي لمع لكر



Chêne naturel  
Natural oak  
Rovere naturale  
Naturele eiken  
بلوط طبيعي



Pin gris  
Grey pine  
Pino-grigio  
Kiefer grau  
Grijs pijn  
سرو رمادي



Noyer  
Dark walnut  
Noce  
Walnuss  
Walnoot  
خشبي جوزي

Finition texture. Texture finish. Finitura trama. Textur-Finish. Textuur afwerking. الانتهاء من الملمس

Organisateur. Organizer unit. Organizzatore. Obere Ablage. Superieure organizer. منظم درج علوي

Fermeture ralentie. Soft close. Frenata soft close. Sanfter Verschluss. Zachtsluitend. نظام إغلاق أوتوماتيكي

Façades réglables. Adjustable front. Frontali regolabili. Einstellbare Vorderseite. Verstelbaar front. الدروج الأمامية قابلة للتعديل

Glissières Hettich. Hettich sliding system. Guide Hettich. Körperschiene Hettich. Hettich lade system. مفصلات الماتية-هتيتش

Mélangine structuré. Textured melamine. Melamina testurizzata. Textur mit Relief. Reliefstructuur. ملمس منقوش

Système anti buée. Anti fog system. Sistema antiappannamento. Anti Beschlag System. نظام ضد الضباب

Lumière ambient. Ambient light. Luce ambiente. Ambient Light. اضاءة خلفية

Capteurs de contact. Contact sensor On/Off. Sensore di con tatto On/Off. Sensorschalter On/Off. Aanraken Schakelaar. حساس لمس اطفاء / تشغيل

Réversible. It is reversible. Reversibile. Umkehrbar. Omkeerbaar. ja استعمال عكسي

# galsaky.120

INDUSTRIAL

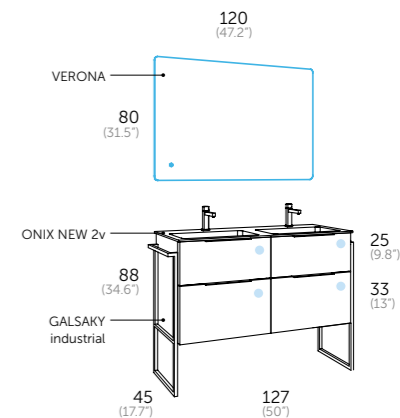

### Composition | chêne naturel

1	150 24 120	<b>Galsaky IND 120</b>
1	550 01 122	<b>Onix new 2v.</b>
1	246 00 120	<b>Verona</b>



### Robinet

2	412 02 800	<b>Combi noir</b>
---	------------	-------------------

**galsaky.IND.60** (23.62")

plan vasque / washbasin / lavabo / waschtisch / wastafels / تروس

Finition	Référence
○ Blanc brillant	150 01 060
● Gris brillant	150 03 060
● Chêne naturel	150 24 060
● Pin gris	150 37 060
● Noyer	150 39 060

<b>ONIX NEW</b> céramique	<b>TOPACIO</b> résine	<b>QUATTRO</b> céramique	<b>MASAI</b>	<b>MASAI</b> plateaux
Référence 550 01 060	Référence 505 01 060	Référence 521 01 060	Référence ○ Blanc 518 01 060 ● Noir 518 02 060 Plus de couleurs à la page 284	Référence ○ Blanc 519 01 060 ● Noir 519 02 060 Plus de couleurs à la page 286

miroirs / mirrors / specchio / spiegel / spiegels / مرآيا

PLAN VASQUES ET MIROIRS PLUS D'OPTIONS DANS LES PAGES 296 - 315

<b>SUN</b>	<b>ROND</b>	<b>RAIN</b> led	<b>VERONA</b> led	<b>VERONA</b> rond led	<b>MÓDENA</b> led	<b>FLASH 60</b> armoire
Référence 204 00 060	Référence 244 00 060	Référence 269 00 060	Référence 246 00 060	Référence 247 00 070	Référence 264 00 080	Référence Aluminium 340 11 060

**galsaky.IND.70** (27.55")

plan vasque / washbasin / lavabo / waschtisch / wastafels / تروس

Finition	Référence
○ Blanc brillant	150 01 070
● Gris brillant	150 03 070
● Chêne naturel	150 24 070
● Pin gris	150 37 070
● Noyer	150 39 070

<b>ONIX NEW</b> céramique	<b>AMBAR</b> mat	<b>MASAI</b>	<b>MASAI</b> plateaux	<b>AMBAR</b> tapa
Référence 550 01 070	Référence 506 01 070	Référence ○ Blanc 518 01 070 ● Noir 518 02 070 Plus de couleurs à la page 284	Référence ○ Blanc 519 01 070 ● Noir 519 02 070 Plus de couleurs à la page 286	Référence 508 01 070

miroirs / mirrors / specchio / spiegel / spiegels / مرآيا

<b>SUN</b>	<b>ROND</b>	<b>RAIN</b> led	<b>VERONA</b> led	<b>VERONA</b> rond led	<b>FLASH 70</b> armoire
Référence 204 00 070	Référence 244 00 070	Référence 269 00 070	Référence 246 00 070	Référence 247 00 070	Référence Aluminium 340 11 070

**galsaky.IND.80** (31.49")

plan vasque / washbasin / lavabo / waschtisch / wastafels / تروس

Finition	Référence
○ Blanc brillant	150 01 080
● Gris brillant	150 03 080
● Chêne naturel	150 24 080
● Pin gris	150 37 080
● Noyer	150 39 080

<b>ONIX NEW</b> céramique	<b>TOPACIO</b> résine	<b>QUATTRO</b> céramique	<b>AMBAR</b> mat	<b>MASAI</b>
Référence 550 01 080	Référence 505 01 080	Référence 521 01 080	Référence 506 01 080	Référence ○ Blanc 518 01 080 ● Noir 518 02 080 Plus de couleurs à la page 284

miroirs / mirrors / specchio / spiegel / spiegels / مرآيا

<b>SUN</b>	<b>SIGMA</b>	<b>RAIN</b> led	<b>VERONA</b> led	<b>VERONA</b> rond led	<b>COSMOS</b> led	<b>SPOTY</b> led	<b>FLASH 80</b> armoire
Référence 204 00 080	Référence 290 00 080	Référence 269 00 080	Référence 246 00 100	Référence 247 00 080	Référence 270 00 080	Référence 267 00 080	Référence Aluminium 340 11 080

**galsaky.IND.100** (39.37")

plan vasque / washbasin / lavabo / waschtisch / wastafels / تروس

Finition	Référence
○ Blanc brillant	150 01 100
● Gris brillant	150 03 100
● Chêne naturel	150 24 100
● Pin gris	150 37 100
● Noyer	150 39 100

<b>ONIX NEW</b> céramique	<b>TOPACIO</b> résine	<b>QUATTRO</b> céramique	<b>AMBAR</b> mat	<b>MASAI</b>
Référence 550 01 100	Référence 505 01 100	Référence 521 01 100	Référence 506 01 100	Référence ○ Blanc 518 01 100 ● Noir 518 02 100 Plus de couleurs à la page 284

miroirs / mirrors / specchio / spiegel / spiegels / مرآيا

<b>SUN</b>	<b>SIGMA</b>	<b>RAIN</b> led	<b>VERONA</b> led	<b>VERONA</b> rond led	<b>COSMOS</b> led	<b>TOWER</b> led	<b>SPOTY</b> led
Référence 204 00 100	Référence 290 00 100	Référence 269 00 100	Référence 246 00 100	Référence 247 00 100	Référence 270 00 100	Référence 262 00 100	Référence 267 00 100

**galsaky.IND.120** (47.24")

plan vasque / washbasin / lavabo / waschtisch / wastafels / تروس

Finition	Référence
○ Blanc brillant	150 01 120
● Gris brillant	150 03 120
● Chêne naturel	150 24 120
● Pin gris	150 37 120
● Noyer	150 39 120

<b>ONIX NEW</b> céramique	<b>TOPACIO</b> résine	<b>AMBAR</b> mat	<b>AMBAR</b> décalé	<b>MASAI</b>
Référence 550 01 122	Référence 505 01 122	Référence 506 01 122	Référence 506 01 121 Droite: 506 01 123	Référence ○ Blanc 518 01 122 ● Noir 518 02 122 Plus de couleurs à la page 284

miroirs / mirrors / specchio / spiegel / spiegels / مرآيا

<b>SUN</b>	<b>SIGMA</b>	<b>VERONA</b> led	<b>SPOTY</b> led
Référence 204 00 120	Référence 290 00 120	Référence 246 00 120	Référence 267 00 120

**auxiliaires / auxiliary units**

**joker.colonne haute**

Finition	Référence
○ Blanc brillant	137 01 435
● Gris brillant	137 03 435
● Chêne naturel	137 24 435
● Pin gris	137 37 435
● Noyer	137 39 435

**joker.auxiliaire**

Finition	Référence
○ Blanc brillant	137 01 445
● Gris brillant	137 03 445
● Chêne naturel	137 24 445
● Pin gris	137 37 445
● Noyer	137 39 445

**étagère.IND**

Finition	Référence
○ Blanc brillant	412 01 700
● Gris brillant	412 03 700
● Chêne naturel	412 24 700
● Pin gris	412 37 700
● Noyer	412 39 700

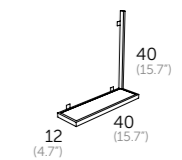
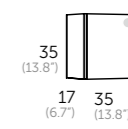
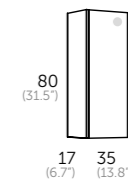

Compatible avec toutes les mesures de miroirs SUN. Emplacement du côté droit seulement.

**landes.plateaux**

avec barre de renfort en aluminium

	Chêne naturel	Pin Gris
60	112 24 206	112 37 206
70	112 24 207	112 37 207
80	112 24 208	112 37 208
100	112 24 210	112 37 210
120	112 24 212	112 37 212

vasque à poser / over countertop basins

<b>ROTTERDAM</b>	<b>ESTAMBUL</b>	<b>OVAL</b>	<b>MASAI</b>	<b>UNIV. CLIC CLAC</b> Valve
Référence 507 01 004	Référence 507 01 005	Référence 509 01 001	● Noir 518 02 051 Plus de couleurs à la page 289	● Noir 410 02 203

éclairage / spotlights

<b>ESTHER BLACK 30</b>	<b>ESTHER BLACK 45</b>
Référence Lumière froide 6000k 400 02 121	Référence Lumière froide 6000k 400 02 191

**COMBI** Robinet

● Chrome  
412 00 800  
más colores pág. 291





# escorpio.

60 / 70 / 80 / 100





## escorpio.60/70

-  Finition texture. Texture finish. Finitura trama. Textur-Finish. Textuur afwerking. الانتهاء من الملمس.
-  Organisateur. Organizer unit. Organizzatore. Obere Ablage. Superieure organizer. متظم درج علوي.
-  Fermeture ralentie. Soft close. Frenata soft close. Sanfter Verschluss. Zachtsluitend. نظام إغلاق اتوماتيكي.
-  Façades réglables. Adjustable front. Frontali regolabili. Einstellbare Vorderseite. Verstelbaar front. الدروع الامامية قابلة للتعديل.
-  Glissières Hettich. Hettich sliding system. Guide Hettich. Korpuschiene Hettich. Hettich lade system. مفصلات الجانبيه.
-  Fermeture ralentie. Soft close. Frenata soft close. Sanfter Verschluss. Zachtsluitend. نظام إغلاق اتوماتيكي.
-  Laquéé brillant. Glossy lacquered finish. Laccato lucido. Glänzend lackiert. Hoogglans gelakt. لكر ميج.
-  Mélamine structurée. Textured melamine. Melamina testurizzata. Textur mit Relief. Reliefstructuur. ملمس منقوش.

-  Blanc brillant  
Glossy white  
Bianco lucido  
Weiss hochglanz  
Witte glans  
أبيض ميج لكر
-  Chêne naturel  
Natural oak  
Rovere naturale  
Natureiche  
Naturele eiken  
بلوط طبيعي
-  Pin gris  
Grey pine  
Pino-grigio  
Kiefer grau  
Grijs pijn  
سرو رمادي
-  Wenge nature  
بني غامق طبيعي

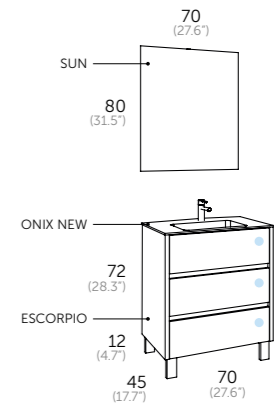

Composition 70 | blanc brillant

1	123 01 070	<b>Escorpio 70</b>
1	550 01 070	<b>Onix new</b>
1	204 00 070	<b>Sun</b>

Robinet

1	412 00 800	<b>Combi chrome</b>
---	------------	---------------------

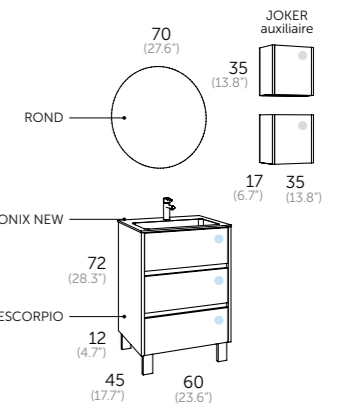

Composition 60 | wenge nature

1	123 44 060	<b>Escorpio 60</b>
1	550 01 060	<b>Onix new</b>
1	244 00 070	<b>Rond 70</b>

Auxiliaires

2	137 44 445	<b>Joker auxiliaire</b>
---	------------	-------------------------

Robinet

1	412 00 800	<b>Combi chrome</b>
---	------------	---------------------



# escorpio.80

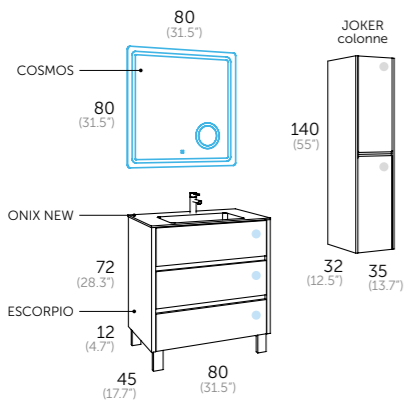

Composition | chêne naturel

1	123 24 080	<b>Escorpio 80</b>
1	550 01 080	<b>Onix new</b>
1	270 00 080	<b>Cosmos</b>

Auxiliaires

1	137 24 335	<b>Joker colonne</b>
---	------------	----------------------

Robinet

1	412 00 800	<b>Combi chrome</b>
---	------------	---------------------

Finition texture. Texture finish. Finitura trama. Textur-Finish. Textuur afwerking. الانتهاء من الملمس

Organisateur. Organizer unit. Organizzatore. Obere Ablage. Superiore organizer. منظم درج علوي

Fermeture ralentie. Soft close. Frenata soft close. Sanfter Verschluss. Zachtsluitend. نظام إغلاق أوتوماتيكي

Façades réglables. Adjustable front. Frontali regolabili. Einstellbare Vorderseite. Verstellbaar front. الدروج الامامية قابلة للتعديل

Glissières Hettich. Hettich sliding system. Guide Hettich. Korpuschiene Hettich. Hettich lade system. مفصلات المانعة-هتيتش

Fermeture ralentie. Soft close. Frenata soft close. Sanfter Verschluss. Zachtsluitend. نظام إغلاق أوتوماتيكي

Melamine structuré. Textured melamine. Melamina testurizzata. Textur mit Relief. Reliefstructuur. ملمس منقوش

Système anti buée. Anti fog system. Sistema antiappannamento. Anti Beschlag System. نظام ضد الضباب

Capteurs de contact. Contact sensor On/Off. Sensore di con tatto On/Off. Sensorschalter On/Off. Aanraken Schakelaar. حساس لمس إطفاء / تشغيل

Miroir loupe 3x éclairé. Magnifying zoom in Mirror. Lente d'ingrandimento 3x. Lupe 3x. Vergrößerung. Vergrootglas. تكبيرية 3 أضعاف



- Blanc brillant  
Glossy white  
Bianco lucido  
Weiss hochglanz  
أبيض لميع لكر
- Chêne naturel  
Natural oak  
Rovere naturale  
Naturele eiken  
بلوط طبيعي
- Pin gris  
Grey pine  
Pino-grigio  
Kiefer grau  
سرو رمادي
- Wenge nature  
بني غامق طبيعي





-  Finition texture. Texture finish. Finitura trama. Textur-Finish. Textuur afwerking. الانتهاء من الملمس
-  Organisateur. Organizer unit. Organizzatore. Obere Ablage. Superieure organizer. منظم درج علوي.
-  Fermeture ralentie. Soft close. Frenata soft close. Sanfter Verschluss. Zachtsluitend. نظام إغلاق اوماتيكي.
-  Façades réglables. Adjustable front. Frontali regolabili. Einstellbare Vorderseite. Verstelbaar front. الدروج الامامية قابلة للتعديل.
-  Glissières Hettich. Hettich sliding system. Guide Hettich. Korpuschiene Hettich. Hettich lade system. مفصلات المانية هيتش.
-  Fermeture ralentie. Soft close. Frenata soft close. Sanfter Verschluss. Zachtsluitend. نظام إغلاق اوماتيكي.
-  Mélangé structuré. Textured melamine. Melamina testurizzata. Textur mit Relief. Relieffstructuur. ملمس منقوش.
-  Système anti buée. Anti fog system. Sistema antiappannamento. Anti Beschlag System. Spiegelverwarming. نظام ضد الضباب.
-  Lumière ambiant. Ambient light. Luce ambiente. Ambient Light. Omgevingslicht. اضاءة خلفية.
-  Capteurs de contact. Contact sensor On/Off. Sensore di con tatto On/Off. Sensorschalter On/Off. Aanraken Schakelaar. حساس لمس اطفاء / تشغيل.
-  Réversible. It is reversible. Reversibile. Umkehrbar. Omkeerbaar; ja. استعملال عكسي.

# escorpio.100

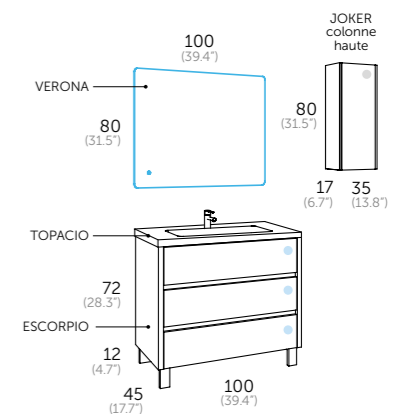

## Composition | pin gris

1	123 37 100	<b>Escorpio 100</b>
1	505 01 100	<b>Topacio</b>
1	246 00 100	<b>Verona</b>

## Auxiliaires

1	137 37 435	<b>Joker colonne haute</b>
---	------------	----------------------------



## Robinet

1	412 00 800	<b>Combi chrome</b>
---	------------	---------------------

			
Blanc brillant Glossy white Bianco lucido Weiss hochglanz Witte glanz أبيض لمع لكر	Chêne naturel Natural oak Rovere naturale Natureiche Natuurle eiken بلوط طبيعي	Pin gris Grey pine Pino-grigio Kiefer grau Grijs pijn سرو رمادي	Wenge nature بني غامق طبيعي



## escorpio.60 (23.62")

plan vasque / washbasin / lavabo / waschtisch / wastafels / تروس

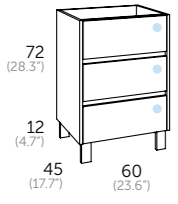

Finition	Référence
○ Blanc brillant	123 01 060
● Chêne naturel	123 24 060
● Pin gris	123 37 060
● Wenge nature	123 44 060



ONIX NEW céramique	TOPACIO résine	QUATTRO céramique	AMBAR mat	MASAI	MASAI plateaux
Référence 550 01 060	Référence 505 01 060	Référence 521 01 060	Référence 506 01 060	Référence ○ Blanc 518 01 060 ● Noir 518 02 060	Référence ○ Blanc 519 01 060 ● Noir 519 02 060

Plus de couleurs à la page 284 Plus de couleurs à la page 286

miroirs / mirrors / specchio / spiegel / spiegels / مرايا

PLAN VASQUES ET MIROIRS PLUS D'OPTIONS DANS LES PAGES 280 - 299

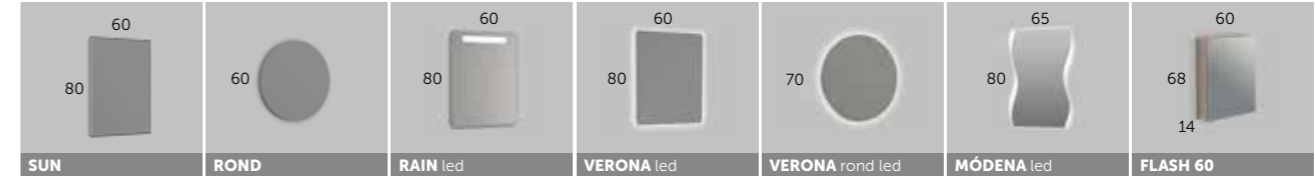

SUN	ROND	RAIN led	VERONA led	VERONA rond led	MODENA led	FLASH 60
Référence 204 00 060	Référence 244 00 060	Référence 269 00 060	Référence 246 00 060	Référence 247 00 070	Référence 264 00 080	Référence Aluminium 340 11 060

## escorpio.70 (27.55")

plan vasque / washbasin / lavabo / waschtisch / wastafels / تروس

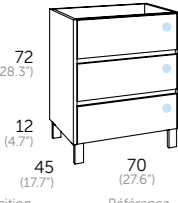

Finition	Référence
○ Blanc brillant	123 01 070
● Chêne naturel	123 24 070
● Pin gris	123 37 070
● Wenge nature	123 44 070



ONIX NEW céramique	AMBAR mat	MASAI	MASAI plateaux	AMBAR plateaux
Référence 550 01 070	Référence 506 01 070	Référence ○ Blanc 518 01 070 ● Noir 518 02 070	Référence ○ Blanc 519 01 070 ● Noir 519 02 070	Référence 508 01 070

Plus de couleurs à la page 284 Plus de couleurs à la page 286

miroirs / mirrors / specchio / spiegel / spiegels / مرايا



SUN	ROND	RAIN led	VERONA led	VERONA rond led	FLASH 70
Référence 204 00 070	Référence 244 00 070	Référence 269 00 070	Référence 246 00 070	Référence 247 00 070	Référence Aluminium 340 11 070

## escorpio.80 (31.49")

plan vasque / washbasin / lavabo / waschtisch / wastafels / تروس

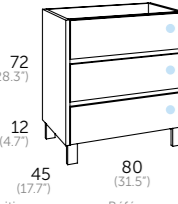

Finition	Référence
○ Blanc brillant	123 01 080
● Chêne naturel	123 24 080
● Pin gris	123 37 080
● Wenge nature	123 44 080



ONIX NEW céramique	TOPACIO résine	QUATTRO céramique	AMBAR mat	MASAI	MASAI plateaux
Référence 550 01 080	Référence 505 01 080	Référence 521 01 080	Référence 506 01 080	Référence ○ Blanc 518 01 080 ● Noir 518 02 080	Référence ○ Blanc 519 01 080 ● Noir 519 02 080

Plus de couleurs à la page 284 Plus de couleurs à la page 286

miroirs / mirrors / specchio / spiegel / spiegels / مرايا



SUN	SIGMA	RAIN led	VERONA led	VERONA rond led	TOWER led	COSMOS led	FLASH 80
Référence 204 00 080	Référence 290 00 080	Référence 269 00 080	Référence 246 00 100	Référence 247 00 080	Référence 262 00 080	Référence 270 00 080	Référence Aluminium 340 11 080

## escorpio.100 (39.37")

plan vasque / washbasin / lavabo / waschtisch / wastafels / تروس

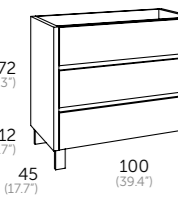

Finition	Référence
○ Blanc brillant	123 01 100
● Chêne naturel	123 24 100
● Pin gris	123 37 100
● Wenge nature	123 44 100



ONIX NEW céramique	TOPACIO résine	QUATTRO céramique	AMBAR mat	MASAI	MASAI plateaux
Référence 550 01 100	Référence 505 01 100	Référence 521 01 100	Référence 506 01 100	Référence ○ Blanc 518 01 100 ● Noir 518 02 100	Référence ○ Blanc 519 01 100 ● Noir 519 02 100

Plus de couleurs à la page 284 Plus de couleurs à la page 286

miroirs / mirrors / specchio / spiegel / spiegels / مرايا



SUN	SIGMA	RAIN led	VERONA led	VERONA rond led	TOWER led	COSMOS led	SPOTY led
Référence 204 00 100	Référence 290 00 100	Référence 269 00 100	Référence 246 00 100	Référence 247 00 100	Référence 262 00 100	Référence 270 00 100	Référence 267 00 100

## landes.plateaux

avec barre de renfort en aluminium

vasque à poser / over countertop basins

éclairage / spotlights

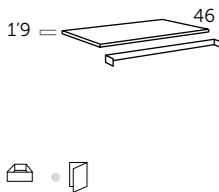

	Chêne naturel	Pin Gris
60	112 24 206	112 37 206
70	112 24 207	112 37 207
80	112 24 208	112 37 208
100	112 24 210	112 37 210



ROTTERDAM	ESTAMBUL
Référence 507 01 004	Référence 507 01 005



ESTHER 30
Référence Lumière froide 6000k 400 00 121

auxiliaires / auxiliary units

### joker.colonne

○ Blanc brillant	137 01 335
● Chêne naturel	137 24 335
● Pin gris	137 37 335
● Wenge nature	137 44 335

Ouverture réversible | Reversible opening

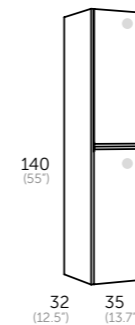

### joker.colonne haute

○ Blanc brillant	137 01 435
● Chêne naturel	137 24 435
● Pin gris	137 37 435
● Wenge nature	137 44 435

Ouverture réversible | Reversible opening

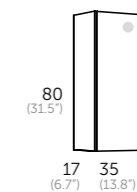

### joker.auxiliaire

○ Blanc brillant	137 01 445
● Chêne naturel	137 24 445
● Pin gris	137 37 445
● Wenge nature	137 44 445

Ouverture réversible | Reversible opening

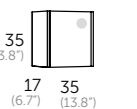



# cervino.

70 / 80 / 90 / 100





# cervino.70

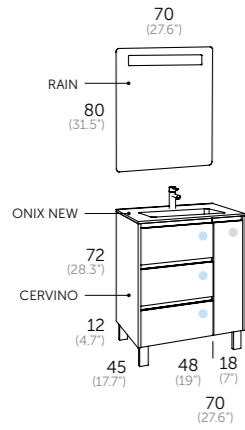

Composition | blanc brillant

1	141 01 070	<b>Cervino 70</b>
1	550 01 070	<b>Onix new</b>
1	269 00 070	<b>Rain</b>



Robinet

1	412 00 800	<b>Combi chrome</b>
---	------------	---------------------

Blanc brillant Glossy white Bianco lucido Weiss hochglanz Witte glans أبيض لامع لكر	Chêne naturel Natural oak Rovere naturale Naturel eiken بلوط طبيعي	Pin gris Grey pine Pino-grigio Kiefer grau Grijs pijn سرو رمادي	Wenge nature بني غامق طبيعي

- Finition texture. Texture finish. Finitura trama. Textur-Finish. Textuur afwerking. الانتهاء من الملمس
- Organisateur. Organizer unit. Organizzatore. Obere Ablage. Superieure organizer. منظم درج علوي
- Fermeture ralentie. Soft close. Frenata soft close. Sanfter Verschluss. Zachtsluitend. نظام إغلاق انوماتيكي
- Façades réglables. Adjustable front. Frontali regolabili. Einstellbare Vorderseite. Verstelbaar front. الدروج الامامية قابلة للتعديل
- Glissières Hettich. Hettich sliding system. Guide Hettich. Korpusschiene Hettich. Hettich lade system. مفصلات الجانبة هيتش
- Fermeture ralentie. Soft close. Frenata soft close. Sanfter Verschluss. Zachtsluitend. نظام إغلاق انوماتيكي
- Laquée brillant. Glossy lacquered finish. Laccato lucido. Glänzend lackiert. Hoogglans gelakt. لكر لامع







- Blanc brillant  
Glossy white  
Bianco lucido  
Weiss hochglanz  
Witte glans  
أبيض لميخ لكر
- Chêne naturel  
Natural oak  
Rovere naturale  
Naturele eiken  
يلوط طبيعي
- Pin gris  
Grey pine  
Pino-grigio  
Kiefer grau  
Grijs pijn  
سرو رمادي
- Wenge nature  
بني غامق طبيعي



## cervino.80

- Finition texture. Texture finish. Finitura trama. Textur-Finish. Textuur afwerking. الانتهاء من الملمس
- Organisateur. Organizer unit. Organizatore. Obere Ablage. Superieure organizer. منظم درج علوي
- Fermeture ralentie. Soft close. Frenata soft close. Sanfter Verschluss. Zachtsluitend. نظام إغلاق أوماتيكي
- Façades réglables. Adjustable front. Frontali regolabili. Einstellbare Vorderseite. Verstelbaar front. الدروع الامامية قابلة للتعديل
- Glissières Hettich. Hettich sliding system. Guide Hettich. Korpussschiene Hettich. Hettich lade system. مفضلات الهاتيك
- Fermeture ralentie. Soft close. Frenata soft close. Sanfter Verschluss. Zachtsluitend. نظام إغلاق أوماتيكي
- Mélamine structurée. Textured melamine. Melamina testurizzata. Textur mit Relief. Relieffstructuur. ملمس منقوش

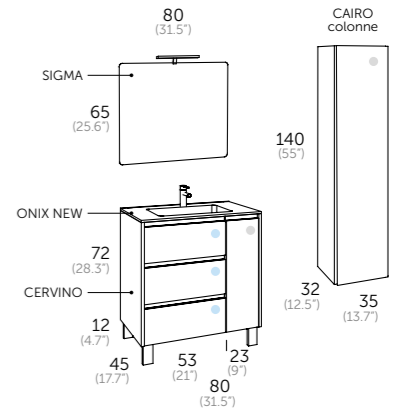

Composition | pin gris

1	141 37 080	<b>Cervino 80</b>
1	550 01 080	<b>Onix new</b>
1	290 00 080	<b>Sigma</b>
1	400 00 121	<b>Esther</b>

Auxiliaires

1	194 37 335	<b>Cairo colonne</b>
---	------------	----------------------

Robinet

1	412 00 800	<b>Combi chrome</b>
---	------------	---------------------



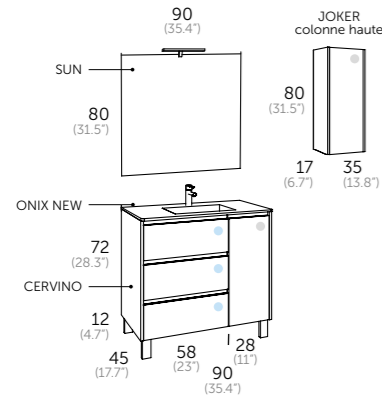

Composition | wenge nature

1	141 44 090	<b>Cervino 90</b>
1	550 01 090	<b>Onix new</b>
1	204 00 090	<b>Sun</b>
1	400 00 121	<b>Esther</b>

Auxiliaires

1	137 44 435	<b>Joker colonne haute</b>
---	------------	----------------------------

Robinet

1	412 00 800	<b>Combi chrome</b>
---	------------	---------------------

## cervino.90

- Finition texture. Texture finish. Finitura trama. Textur-Finish. Textuur afwerking. الانتهاء من الملمس
- Organisateur. Organizer unit. Organizzatore. Obere Ablage. Superieure organizer. منظم درج علوي
- Fermeture ralentie. Soft close. Frenata soft close. Sanfter Verschluss. Zachtsluitend. نظام إغلاق أوتوماتيكي
- Façades réglables. Adjustable front. Frontali regolabili. Einstellbare Vorderseite. Verstellbaar front. الدروج الامامية قابلة للتعديل
- Glissières Hettich. Hettich sliding system. Guide Hettich. Korpusschiene Hettich. Hettich lade system. مفصلات المانيةهتيش
- Fermeture ralentie. Soft close. Frenata soft close. Sanfter Verschluss. Zachtsluitend. نظام إغلاق أوتوماتيكي
- Melamine structuré. Textured melamine. Melamina testurizzata. Textur mit Relief. Reliefstruktur. ملمس منقوش

- Blanc brillant  
Glossy white  
Bianco lucido  
Weiss hochglanz  
Witte glans  
أبيض لميع لكر
- Chêne naturel  
Natural oak  
Rovere naturale  
Naturreiche  
Natuurle eiken  
بلوط طبيعي
- Pin gris  
Grey pine  
Pino-grigio  
Kiefer grau  
Grijs pijn  
سرو رمادي
- Wenge nature  
بني غامق طبيعي



## cervino.100

- Finition texture. Texture finish. Finitura trama. Textur-Finish. Textuur afwerking. الانتهاء من الملمس
- Organisateur. Organizer unit. Organizzatore. Obere Ablage. Superieure organizer. منظم درج علوي
- Fermeture ralentie. Soft close. Frenata soft close. Sanfter Verschluss. Zachtsluitend. نظام إغلاق أوتوماتيكي
- Façades réglables. Adjustable front. Frontali regolabili. Einstellbare Vorderseite. Verstellbaar front. الدروج الامامية قابلة للتعديل
- Glissières Hettich. Hettich sliding system. Guide Hettich. Korpusschiene Hettich. Hettich lade system. مفصلات المانيةهتيش
- Fermeture ralentie. Soft close. Frenata soft close. Sanfter Verschluss. Zachtsluitend. نظام إغلاق أوتوماتيكي
- Melamine structuré. Textured melamine. Melamina testurizzata. Textur mit Relief. Reliefstruktur. ملمس منقوش

- Système anti buée. Anti fog system. Sistema antiappannamento. Anti Beschlag System. نظام ضد الضباب
- Lumière ambient. Ambient light. Luce ambiente. Ambient Light. أضواء خلفية
- Capteurs de contact. Contact sensor On/Off. Sensore di con tatto On/Off. Sensorschalter On/Off. Aanraken Schakelaar. حساس لمس إطفاء / تشغيل
- Réversible. It is reversible. Reversibile. Umkehrbar. Omkeerbaar. ja استعمال عكسي

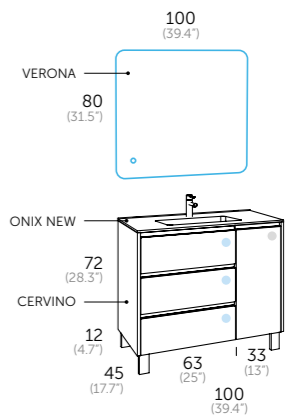

Composition | chêne naturel

1	141 24 100	<b>Cervino 100</b>
1	550 01 100	<b>Onix new</b>
1	246 00 100	<b>Verona</b>

Robinet

1	412 00 800	<b>Combi chrome</b>
---	------------	---------------------

## cervino.70 (27.55")

plan vasque / washbasin / lavabo / waschtisch / wastafels / تروس

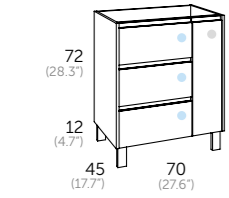

Finition	Référence
○ Blanc brillant	141 01 070
● Chêne naturel	141 24 070
● Pin gris	141 37 070
● Wenge nature	141 44 070



ONIX NEW céramique	AMBAR mat	MASAI	MASAI plateaux	AMBAR plateaux
Référence 550 01 070	Référence 506 01 070	Référence ○ Blanc 518 01 070 ● Noir 518 02 070	Référence ○ Blanc 519 01 070 ● Noir 519 02 070	Référence 508 01 070

Plus de couleurs à la page 284

Plus de couleurs à la page 286

## cervino.80 (31.49")

plan vasque / washbasin / lavabo / waschtisch / wastafels / تروس

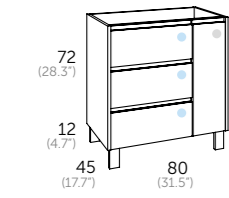

Finition	Référence
○ Blanc brillant	141 01 080
● Chêne naturel	141 24 080
● Pin gris	141 37 080
● Wenge nature	141 44 080

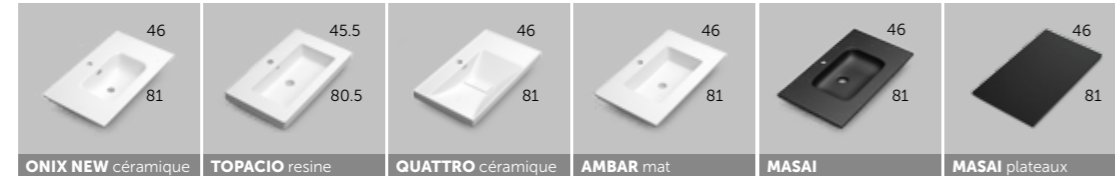

ONIX NEW céramique	TOPACIO resine	QUATTRO céramique	AMBAR mat	MASAI	MASAI plateaux
Référence 550 01 080	Référence 505 01 080	Référence 521 01 080	Référence 506 01 080	Référence ○ Blanc 518 01 080 ● Noir 518 02 080	Référence ○ Blanc 519 01 080 ● Noir 519 02 080

Plus de couleurs à la page 284

Plus de couleurs à la page 286

## cervino.90 (35.43")

plan vasque / washbasin / lavabo / waschtisch / wastafels / تروس

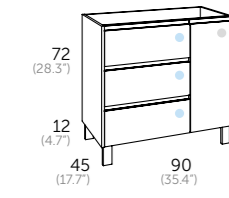

Finition	Référence
○ Blanc brillant	141 01 090
● Chêne naturel	141 24 090
● Pin gris	141 37 090
● Wenge nature	141 44 090



ONIX NEW céramique	MASAI	MASAI plateaux
Référence 550 01 090	Référence ○ Blanc 518 01 090 ● Noir 518 02 090	Référence ○ Blanc 519 01 090 ● Noir 519 02 090

Plus de couleurs à la page 284

Plus de couleurs à la page 286

## cervino.100 (39.37")

plan vasque / washbasin / lavabo / waschtisch / wastafels / تروس

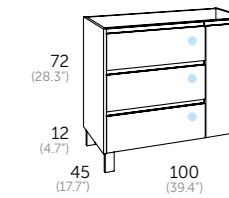

Finition	Référence
○ Blanc brillant	141 01 100
● Chêne naturel	141 24 100
● Pin gris	141 37 100
● Wenge nature	141 44 100

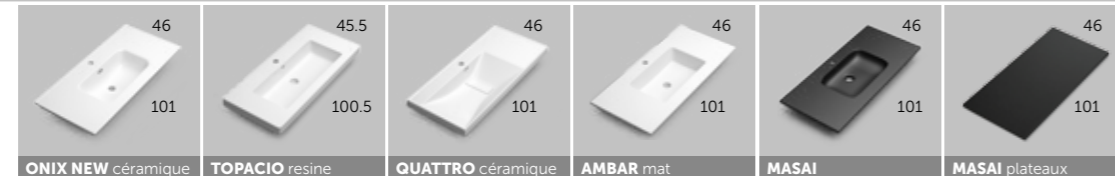

ONIX NEW céramique	TOPACIO resine	QUATTRO céramique	AMBAR mat	MASAI	MASAI plateaux
Référence 550 01 100	Référence 505 01 100	Référence 521 01 100	Référence 506 01 100	Référence ○ Blanc 518 01 100 ● Noir 518 02 100	Référence ○ Blanc 519 01 100 ● Noir 519 02 100

Plus de couleurs à la page 284

Plus de couleurs à la page 286

## landes.plateaux

avec barre de renfort en aluminium

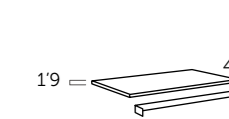

	Chêne naturel	Pin Gris
70	112 24 207	112 37 207
80	112 24 208	112 37 208
90	112 24 209	112 37 209
100	112 24 210	112 37 210

vasque à poser / over countertop basins

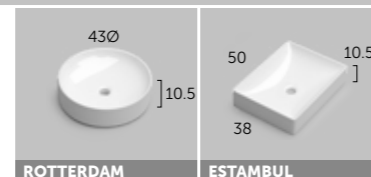

ROTTERDAM	ESTAMBUL
Référence 507 01 004	Référence 507 01 005

éclairage / spotlights



ESTHER 30
Référence Lumière froide 6000k 400 00 121

miroirs / mirrors / specchio / spiegel / spiegels / مرايا

PLAN VASQUES ET MIROIRS PLUS D'OPTIONS DANS LES PAGES 280 - 299



SUN	ROND	RAIN led	VERONA led	VERONA rond led	FLASH 70
Référence 204 00 070	Référence 244 00 070	Référence 269 00 070	Référence 246 00 070	Référence 247 00 070	Référence Aluminium 340 11 070

miroirs / mirrors / specchio / spiegel / spiegels / مرايا

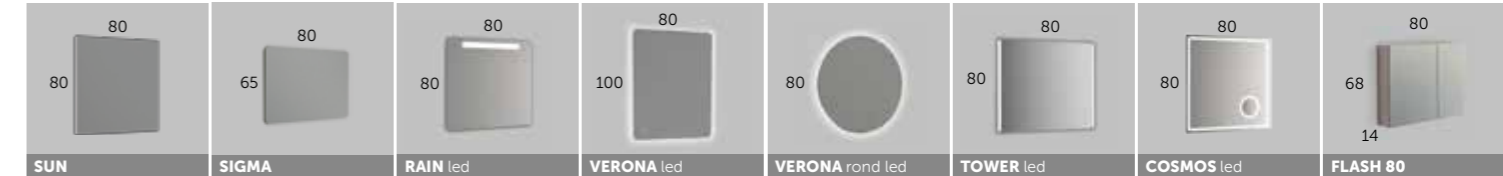

SUN	SIGMA	RAIN led	VERONA led	VERONA rond led	TOWER led	COSMOS led	FLASH 80
Référence 204 00 080	Référence 290 00 080	Référence 269 00 080	Référence 246 00 100	Référence 247 00 080	Référence 262 00 080	Référence 270 00 080	Référence Aluminium 340 11 080

miroirs / mirrors / specchio / spiegel / spiegels / مرايا

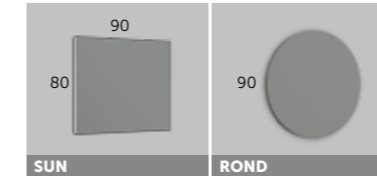

SUN	ROND
Référence 204 00 090	Référence 244 00 090

miroirs / mirrors / specchio / spiegel / spiegels / مرايا



SUN	SIGMA	RAIN led	VERONA led	VERONA rond led	TOWER led	COSMOS led	SPOTY led
Référence 204 00 100	Référence 290 00 100	Référence 269 00 100	Référence 246 00 100	Référence 247 00 100	Référence 262 00 100	Référence 270 00 100	Référence 267 00 100

auxiliaires / auxiliary units

### cairo.colonne

Finition	Référence
○ Blanc brillant	194 01 335
● Chêne naturel	194 24 335
● Pin gris	194 37 335
● Wenge nature	194 44 335

Ouverture réversible | Reversible opening

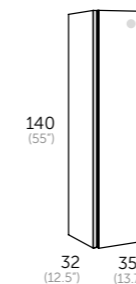

### joker.colonne haute

Finition	Référence
○ Blanc brillant	137 01 435
● Chêne naturel	137 24 435
● Pin gris	137 37 435
● Wenge nature	137 44 435

Ouverture réversible | Reversible opening

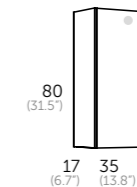

### joker.auxiliaire

Finition	Référence
○ Blanc brillant	137 01 445
● Chêne naturel	137 24 445
● Pin gris	137 37 445
● Wenge nature	137 44 445

Ouverture réversible | Reversible opening

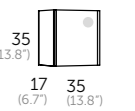





**comet.** profondeur réduite

60 / 70 / 80





# comet.70

profondeur réduite

Blanc brillant  
 Glossy white  
 Bianco lucido  
 Weiss hochglanz  
 Witte glans  
 أبيض لميع لكر

Chêne naturel  
 Natural oak  
 Rovere naturale  
 Naturele eiken  
 بلوط طبيعي

- 
 Finition texture. Texture finish. Finitura trama. Textur-Finish. Textuur afwerking. الانتهاء من الملمس.
- 
 Organisateur. Organizer unit. Organizzatore. Obere Ablage. Superieure organizer. منظم درج علوي.
- 
 Fermeture ralentie. Soft close. Frenata soft close. Sanfter Verschluss. Zachtsluitend. نظام إغلاق أوماتيكي.
- 
 Façades réglables. Adjustable front. Frontali regolabili. Einstellbare Vorderseite. Verstelbaar front. الدروج الامامية قابلة للتعديل.
- 
 Glissières Hettich. Hettich sliding system. Guide Hettich. Korpuschiene Hettich. Hettich lade system. مفضلات المانية هيتش.
- 
 Fermeture ralentie. Soft close. Frenata soft close. Sanfter Verschluss. Zachtsluitend. نظام إغلاق أوماتيكي.
- 
 Mèlamine structuré. Textured melamine. Melamina testurizzata. Textur mit Relief. Reliefstructuur. ملمس منقوش.

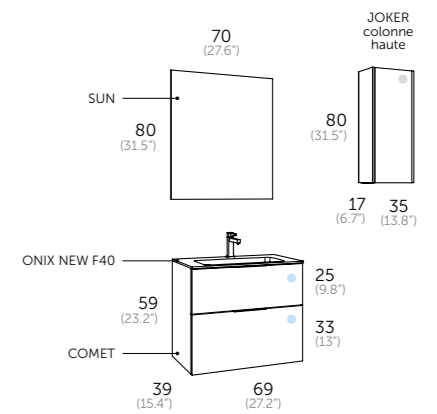

Composition | chêne naturel

1	152 24 070	<b>Comet 70</b>
1	551 01 070	<b>Onix new F40</b>
1	204 00 070	<b>Sun</b>

Auxiliaires

1	137 24 435	<b>Joker colonne haute</b>
---	------------	----------------------------

Robinet

1	412 00 800	<b>Combi chrome</b>
---	------------	---------------------



# comet.80

profondeur réduite



option poignées noires

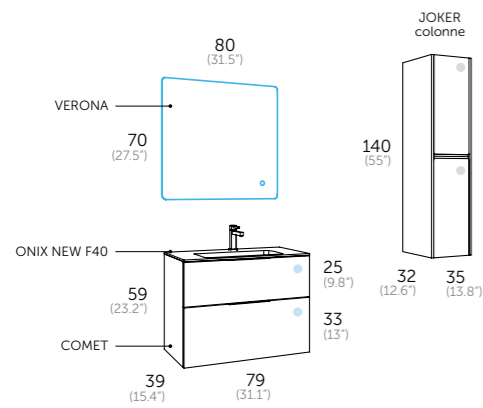

### Composition | blanc brillant

1	152 01 080	<b>Comet 80</b>
1	551 01 080	<b>Onix new F40</b>
1	246 00 070	<b>Verona</b>

### Auxiliaires

1	137 01 335	<b>Joker colonne</b>
---	------------	----------------------



### Robinet

1	412 00 800	<b>Combi chrome</b>
---	------------	---------------------

- Finition texture. Texture finish. Finitura trama. Textur-Finish. Textuur afwerking. الانتهاء من الملمس
- Organisateur. Organizer unit. Organizzatore. Obere Ablage. Superieure organizer. منظم درج علوي
- Fermeture ralentie. Soft close. Frenata soft close. Sanfter Verschluss. Zachtsluitend. نظام إغلاق أوتوماتيكي
- Façades réglables. Adjustable front. Frontali regolabili. Einstellbare Vorderseite. Verstellbaar front. الدروج الامامية قابلة للتعديل
- Glissières Hettich. Hettich sliding system. Guide Hettich. Korpuschiene Hettich. Hettich lade system. مفصلات الجانبيههتيش
- Fermeture ralentie. Soft close. Frenata soft close. Sanfter Verschluss. Zachtsluitend. نظام إغلاق أوتوماتيكي
- Laquéé brillant. Glossy lacquered finish. Laccato lucido. Glanzend lackiert. Hoogglans gelakt. لكر ليح
- Système anti buée. Anti fog system. Sistema antiappannamento. Anti Beschlag System. نظام ضد الضباب
- Lumière ambiant. Ambient light. Luce ambiente. Ambient Light. أضادة خلفية
- Capteurs de contact. Contact sensor On/Off. Sensore di con tatto On/Off. Sensorschalter On/Off. Aanraken Schakelaar. حساس لمس اطفاء / تشغيل
- Réversible. It is reversible. Reversibile. Umkehrbar. Omkeerbaar: ja. استعمال عكسي



Blanc brillant  
Glossy white  
Bianco lucido  
Weiss hochglanz  
أبيض ليح لكر



Chêne naturel  
Natural oak  
Rovere naturale  
Natureiche  
Naturele eiken  
بلوط طبيعي

**comet.60** (23.62")

plan vasque / washbasin / lavabo / waschtisch / wastafels / تروس

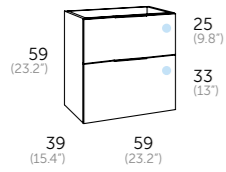

**ONIX NEW f40**  
Référence  
**551 01 060**

- Finition Référence
- Blanc brillant 152 01 060
  - Chêne naturel 152 24 060

**comet.70** (27.55")

plan vasque / washbasin / lavabo / waschtisch / wastafels / تروس

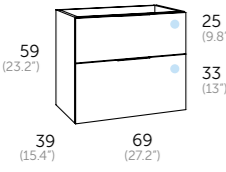

**ONIX NEW f40**  
Référence  
**551 01 070**

- Finition Référence
- Blanc brillant 152 01 070
  - Chêne naturel 152 24 070

**comet.80** (31.49")

plan vasque / washbasin / lavabo / waschtisch / wastafels / تروس

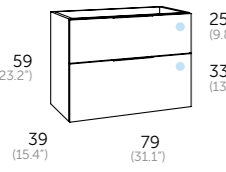

**ONIX NEW f40**  
Référence  
**551 01 080**

- Finition Référence
- Blanc brillant 152 01 080
  - Chêne naturel 152 24 080

**auxiliaires** / auxiliary units

**joker.colonne**

- Finition Référence
- Blanc brillant 137 01 335
  - Chêne naturel 137 24 335

Ouverture réversible | Reversible opening

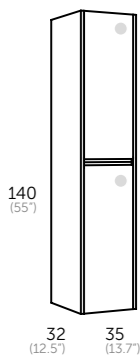

**joker.colonne haute**

- Finition Référence
- Blanc brillant 137 01 435
  - Chêne naturel 137 24 435

Ouverture réversible | Reversible opening

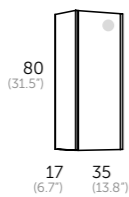

**joker.auxiliaire**

- Finition Référence
- Blanc brillant 137 01 445
  - Chêne naturel 137 24 445

Ouverture réversible | Reversible opening

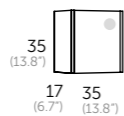

**POIGNÉES** noir  
Référence  
**412 02 730**

miroirs / mirrors / specchio / spiegel / spiegels / مرآيا

PLAN VASQUES ET MIROIRS PLUS D'OPTIONS DANS LES PAGES 280 - 299

<b>SUN</b>	<b>ROND</b>	<b>RAIN led</b>	<b>VERONA led</b>	<b>VERONA rond led</b>	<b>MÓDENA led</b>	<b>FLASH 60</b>
Référence <b>204 00 060</b>	Référence <b>244 00 060</b>	Référence <b>269 00 060</b>	Référence <b>246 00 060</b>	Référence <b>247 00 070</b>	Référence <b>264 00 080</b>	Référence Aluminium <b>340 11 060</b>

miroirs / mirrors / specchio / spiegel / spiegels / مرآيا

<b>SUN</b>	<b>ROND</b>	<b>RAIN led</b>	<b>VERONA led</b>	<b>VERONA rond led</b>	<b>FLASH 70</b>
Référence <b>204 00 070</b>	Référence <b>244 00 070</b>	Référence <b>269 00 070</b>	Référence <b>246 00 070</b>	Référence <b>247 00 070</b>	Référence Aluminium <b>340 11 070</b>

miroirs / mirrors / specchio / spiegel / spiegels / مرآيا

<b>SUN</b>	<b>SIGMA</b>	<b>RAIN led</b>	<b>VERONA led</b>	<b>VERONA rond led</b>	<b>TOWER led</b>	<b>COSMOS led</b>	<b>FLASH 80</b>
Référence <b>204 00 080</b>	Référence <b>290 00 080</b>	Référence <b>269 00 080</b>	Référence <b>246 00 100</b>	Référence <b>247 00 080</b>	Référence <b>262 00 080</b>	Référence <b>270 00 080</b>	Référence Aluminium <b>340 11 080</b>

éclairage / spotlights

<b>EVA</b>	<b>NEREA MAT</b>	<b>ESTHER 30</b>	<b>SOFIA 60</b>
Référence Lumière froide 4000k <b>400 00 011</b>	Référence Lumière froide 6000k <b>400 14 161</b>	Référence Lumière froide 6000k <b>400 00 121</b>	Référence Lumière froide 6000k <b>400 00 141</b>



**UNIV. CLIC CLAC** Valve.  
● Chrome  
**410 00 203**  
Plus de couleurs à la page 330



**COMBI** Robinet  
● Chrome  
**412 00 800**  
Plus de couleurs à la page 291



**berna.** profondeur réduite

50 / 60

**siena.** profondeur réduite

70 / 80



# berna.50

profondeur réduite

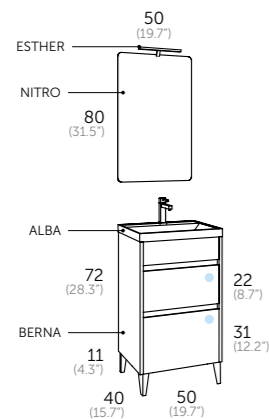

Composition | blanc brillant

1	140 01 050	<b>Berna 50</b>
1	510 01 050	<b>Alba</b>
1	241 00 050	<b>Nitro</b>
1	400 00 121	<b>Esther</b>



Robinet

1	412 00 800	<b>Combi chrome</b>
---	------------	---------------------

- Finition texture. Texture finish. Finitura trama. Textur-Finish. Textuur afwerking. الانتهاء من الخمس.
- Organisateur. Organizer unit. Organizzatore. Obere Ablage. Superieure organizer. منظم درج علوي.
- Fermeture ralentie. Soft close. Frenata soft close. Sanfter Verschluss. Zachtsluitend. نظام إغلاق أوتوماتيكي.
- Façades réglables. Adjustable front. Frontali regolabili. Einstellbare Vorderseite. Verstelbaar front. الدروج الامامية قابلة للتعديل.
- Glissières Hettich. Hettich sliding system. Guide Hettich. Korpuschiene Hettich. Hettich lade system. مفصلات المانية هيتش.
- Laquéé brillant. Glossy lacquered finish. Laccato lucido. Glanzend lackiert. Hoogglans gelakt. لكر لميع.



# berna.60

profondeur réduite

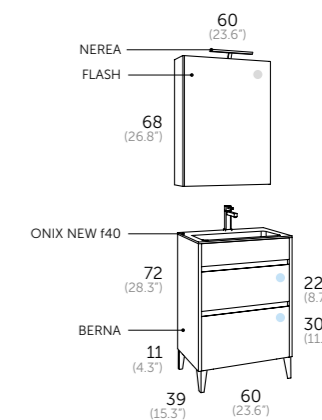

Composition | chêne naturel

1	140 24 060	<b>Berna 60</b>
1	551 01 060	<b>Onix new F40</b>
1	340 11 060	<b>Flash</b>
1	400 14 161	<b>Nerea</b>



Robinet

1	412 00 800	<b>Combi chrome</b>
---	------------	---------------------

- Blanc brillant  
Glossy white  
Bianco lucido  
Weiss hochglanz  
Witte glanz  
أبيض لميع لكر
- Chêne naturel  
Natural oak  
Rovere naturale  
Natureiche  
Natureel eiken  
بلوط طبيعي



- Finition texture. Texture finish. Finitura trama. Textur-Finish. Textuur afwerking. الانتهاء من الخمس.
- Organisateur. Organizer unit. Organizzatore. Obere Ablage. Superieure organizer. منظم درج علوي.
- Fermeture ralentie. Soft close. Frenata soft close. Sanfter Verschluss. Zachtsluitend. نظام إغلاق أوتوماتيكي.
- Façades réglables. Adjustable front. Frontali regolabili. Einstellbare Vorderseite. Verstelbaar front. الدروج الامامية قابلة للتعديل.
- Glissières Hettich. Hettich sliding system. Guide Hettich. Korpuschiene Hettich. Hettich lade system. مفصلات المانية هيتش.
- Mélamine structurée. Textured melamine. Melamina testurizzata. Textur mit Relief. Reliefstructuur. ملمس منقوش.



# siena.70

profondeur réduite

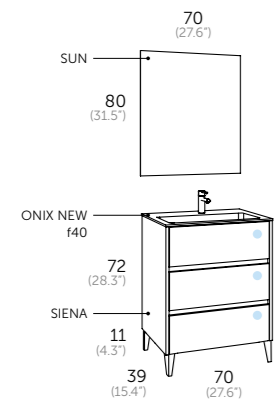

### Composition | blanc brillant

1	144 01 070	<b>Siena 70</b>
1	551 01 070	<b>Onix new F40</b>
1	204 00 070	<b>Sun</b>



### Robinet

1	412 00 800	<b>Combi chrome</b>
---	------------	---------------------

Finition texture. Texture finish. Finitura trama. Textur-Finish. Textuur afwerking. الانتهاء من الملمس

Organisateur. Organizer unit. Organizzatore. Obere Ablage. Superieure organizer. منظم درج علوي

Fermeture ralentie. Soft close. Frenata soft close. Sanfter Verschluss. Zachtsluitend. نظام إغلاق أوتوماتيكي

Façades réglables. Adjustable front. Frontali regolabili. Einstellbare Vorderseite. Verstellbaar front. الدروج الأمامية قابلة للتعديل

Glissières Hetrich. Hetrich sliding system. Guide Hetrich. Körperschiene Hetrich. Hetrich lade system. مفصلات الماينة هيتش

Laquéé brillant. Glossy lacquered finish. Laccato lucido. Glänzend lackiert. Hoogglans gelakt. أبيض لميع لكر



Blanc brillant  
Glossy white  
Bianco lucido  
Weiss hochglanz  
Witte glans  
أبيض لميع لكر



Chêne naturel  
Natural oak  
Rovere naturale  
Naturel eiken  
بلوط طبيعي



# siena.80

profondeur réduite

Composition | chêne naturel

1	144 24 080	<b>Siena 80</b>
1	551 01 080	<b>Onix new F40</b>
1	290 00 080	<b>Sigma</b>
1	400 14 161	<b>Nerea mate</b>

Auxiliaires

2	137 24 445	<b>Joker auxiliaire</b>
---	------------	-------------------------



Robinet

1	412 00 800	<b>Combi chrome</b>
---	------------	---------------------

- Finition texture. Texture finish. Finitura trama. Textur-Finish. Textuur afwerking. الانتهاء من الملمس
- Organisateur. Organizer unit. Organizzatore. Obere Ablage. Superiore organizer. منظم درج علوي
- Fermeture ralentie. Soft close. Frenata soft close. Sanfter Verschluss. Zachtsluitend. نظام إغلاق أوتوماتيكي
- Façades réglables. Adjustable front. Frontali regolabili. Einstellbare Vorderseite. Verstelbaar front. الدروج الامامية قابلة للتعديل
- Glissières Hettich. Hettich sliding system. Guide Hettich. Korpusschiene Hettich. Hettich lade system. مخفضات المانعة هيتش
- Fermeture ralentie. Soft close. Frenata soft close. Sanfter Verschluss. Zachtsluitend. نظام إغلاق أوتوماتيكي
- Mélamine structuré. Textured melamine. Melamina testurizzata. Textur mit Relief. Reliefstruktur. ملمس منقوش

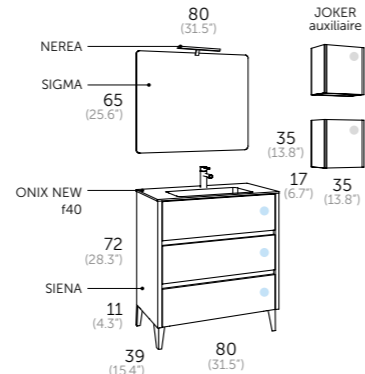

- Blanc brillant  
Glossy white  
Bianco lucido  
Weiss hochglanz  
Witte glans  
أبيض لمع لكر
- Chêne naturel  
Natural oak  
Rovere naturale  
Natuurlike eiken  
بلوط طبيعي

## berna.50 (23.62")

plan vasque / washbasin

miroirs / mirrors

PLAN VASQUES ET MIROIRS PLUS D'OPTIONS DANS LES PAGES 280 - 299

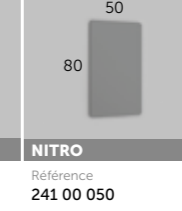
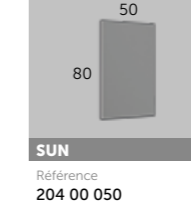
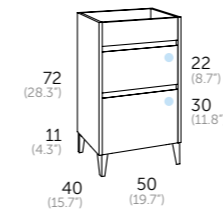

- Blanc brillant 140 01 050
- Chêne naturel 140 24 050

## berna.60 (23.62")

plan vasque / washbasin

miroirs / mirrors

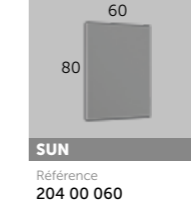
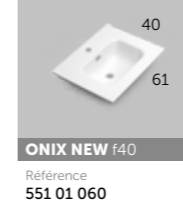
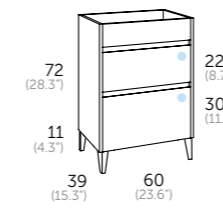

- Blanc brillant 140 01 060
- Chêne naturel 140 24 060

## siena.70 (27.55")

plan vasque / washbasin

miroirs / mirrors

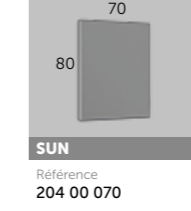
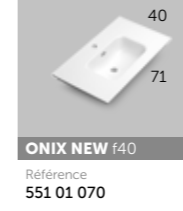
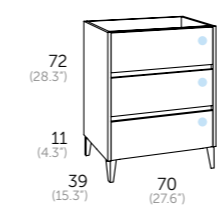

- Blanc brillant 144 01 070
- Chêne naturel 144 24 070

## siena.80 (31.49")

plan vasque / washbasin

miroirs / mirrors

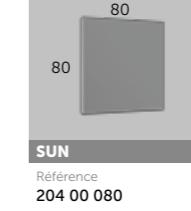
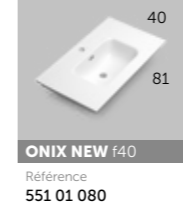
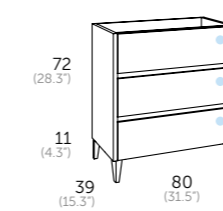

- Blanc brillant 144 01 080
- Chêne naturel 144 24 080

## auxiliaires / auxiliary units

### joker.colonne

- Blanc brillant 137 01 335
- Chêne naturel 137 24 335

Ouverture réversible | Reversible opening

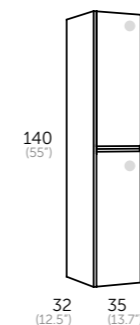

### joker.colonne haute

- Blanc brillant 137 01 435
- Chêne naturel 137 24 435

Ouverture réversible | Reversible opening

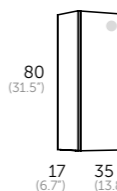

### joker.auxiliaire

- Blanc brillant 137 01 445
- Chêne naturel 137 24 445

Ouverture réversible | Reversible opening

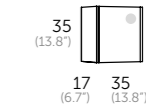





**versa.** profondeur réduite

45 / 55





# versa.45

profondeur réduite

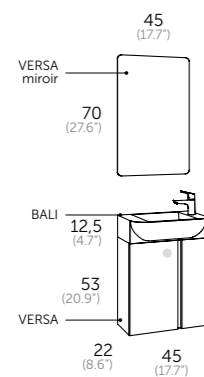

Composition | chêne naturel

1	145 24 045	<b>Versa 45</b>
1	515 01 045	<b>Bali céramique</b>
1	208 00 045	<b>Versa 45 miroir</b>



## Bali 45 céramique

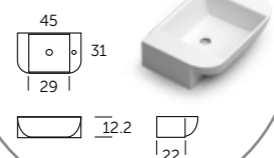

Fermeture ralentie. Soft close.  
Frenata soft close. Sanfter Verschluss.  
Zachtsluitend. نظام إغلاق اتوماتيكي.

Mélamine structuré. Textured melamine.  
Melamina testurizzata. Textur mit Relief.  
Reliefstructuur. ملمس متقوس.

Laquée brillant. Glossy lacquered finish.  
Laccato lucido. Glanzend lackiert.  
Hoogglans gelakt. لكر لميع.



Blanc brillant  
Glossy white  
Bianco lucido  
Weiss hochglanz  
Witte glans  
أبيض لميع لكر



Chêne naturel  
Natural oak  
Rovere naturale  
Naturliche  
Naturel eiken  
بلوط طبيعي

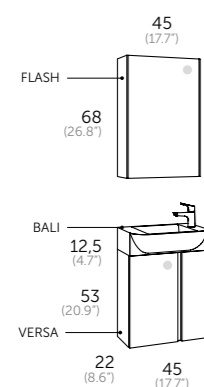

Composition | blanc brillant

1	145 01 045	<b>Versa 45</b>
1	515 01 045	<b>Bali céramique</b>
1	340 11 045	<b>Flash 45</b>





# versa.55

profondeur réduite

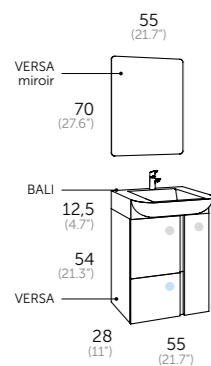

Composition | blanc brillant

1	145 01 055	<b>Versa 55</b>
1	515 01 055	<b>Bali céramique</b>
1	208 00 055	<b>Versa miroir</b>



- Finition texture. Texture finish. Finitura trama. Textur-Finish. Textuur afwerking. الانتهاء من الملمس
- Fermeture ralentie. Soft close. Frenata soft close. Sanfter Verschluss. Zachtsluitend. نظام إغلاق أومائيكي.
- Façades réglables. Adjustable front. Frontali regolabili. Einstellbare Vorderseite. Verstelbaar front. الدرّوج الأمامية قابلة للتعديل.
- Glissières Hettich. Hettich sliding system. Guide Hettich. Körperschiene Hettich. Hettich lade system. مفصلات الجانبيّة هيتش.
- Fermeture ralentie. Soft close. Frenata soft close. Sanfter Verschluss. Zachtsluitend. نظام إغلاق أومائيكي.
- Laquéé brillant. Glossy lacquered finish. Laccato lucido. Glanzend lackiert. Hoogglans gelakt. إيض لميخ لكر.

- Blanc brillant  
Glossy white  
Bianco lucido  
Weiss hochglanz  
Witte glanz  
ايض لميخ لكر
- Chêne naturel  
Natural oak  
Rovere naturale  
Naturliche  
Naturle eiken  
بلوط طبيعي





# versa.55

profondeur réduite

-  Finition texture. Texture finish. Finitura trama. Textur-Finish. Textuur afwerking. الانتباه من الملمس
-  Fermeture ralentie. Soft close. Frenata soft close. Sanfter Verschluss. Zachtsluitend. نظام إغلاق التوماتيكي
-  Façades réglables. Adjustable front. Frontali regolabili. Einstellbare Vorderseite. Verstelbaar front. الدروج الامامية قابلة للتعديل
-  Glissières Hettich. Hettich sliding system. Guide Hettich. Korpuschiene Hettich. Hettich lade system. مفصلات الخزانة هيتش
-  Fermeture ralentie. Soft close. Frenata soft close. Sanfter Verschluss. Zachtsluitend. نظام إغلاق التوماتيكي
-  Mélangé structuré. Textured melamine. Melamina testurizzata. Textur mit Relief. Reliefstructuur. ملمس منقوش

Composition | chêne naturel

1	145 24 055	<b>Versa 55</b>
1	515 01 055	<b>Bali céramique</b>
1	340 11 055	<b>Flash 55</b>

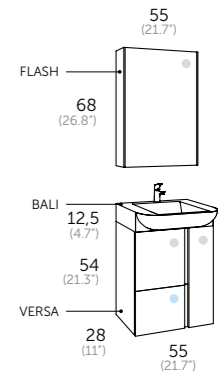

## versa.45 (17.71")

plan vasque / washbasin

miroirs / mirrors

éclairage / spotlights

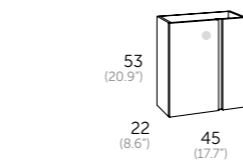

Finition	Référence
○ Blanc brillant	145 01 045
● Chêne naturel	145 24 045



**BALI** céramique  
Référence  
515 01 045

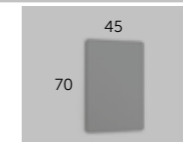

**VERSA**  
Référence  
208 00 045



**FLASH 45** armoire  
Référence  
Aluminium  
340 11 045



**NEREA MAT**  
Référence  
Lumière froide 6000k  
400 14 161



**ESTHER 30**  
Référence  
Lumière froide 6000k  
400 00 121  
Lumière chaude 3000k  
400 00 221

## versa.55 (21.65")

plan vasque / washbasin

miroirs / mirrors

éclairage / spotlights

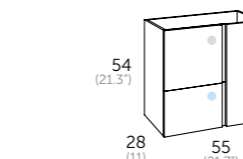

Finition	Référence
○ Blanc brillant	145 01 055
● Chêne naturel	145 24 055



**BALI** céramique  
Référence  
515 01 055

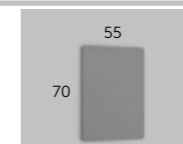

**VERSA**  
Référence  
208 00 055



**FLASH 55** armoire  
Référence  
Aluminium  
340 11 055



**EVA**  
Référence  
Lumière froide 4000k  
400 00 011



**ESTHER 30**  
Référence  
Lumière froide 6000k  
400 00 121  
Lumière chaude 3000k  
400 00 221







## stone.compact

Nouvelle ligne de lavabos et de plans de toilette Stone Compact fabriquée en **Pierre naturelle compacte** qui lui apporte une durabilité et une résistance supérieures au reste des matériaux. Son revêtement externe la protège de tout agent externe et maintient intacts la texture, la couleur et le toucher de la pierre. De plus, il évite les taches et facilite le nettoyage permettant d'utiliser n'importe quel produit agressif, bien qu'il soit recommandé d'utiliser des produits neutres et des éponges grattantes non abrasives.

The new Stone Compact range of sinks and worktops is made from **natural compact stone**, which provides a level of strength and durability superior to other materials. It's external coating protects it from all kinds of external agents and ensures that the texture, colour and feel of the stone is kept intact. It also prevents stains and makes cleaning easier, allowing the use of any cleaning products, however aggressive they are. Of course, it is always best to try and use neutral products and non-scratch sponges.



Sur demande. On request.  
Délai de livraison 20 jours.

Ref: (50)

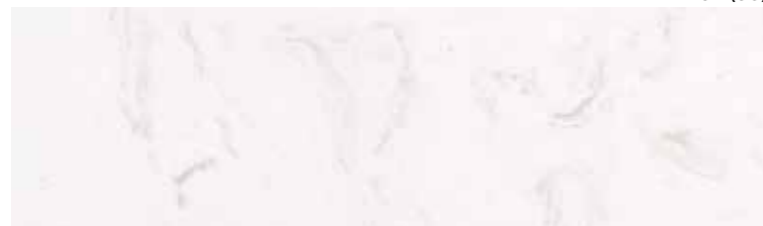

Calacatta

Ref: (51)



Verona

Ref: (52)



Gris polar

Ref: (53)



Coffee

Ref: (54)



Portoro

Ref: (55)



Negro marquina

Ref: (56)



Blanco estatuario

Ref: (57)



Blanco

Ref: (58)

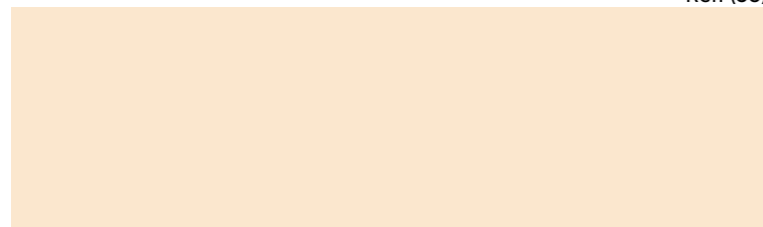

Crema

Ref: (59)

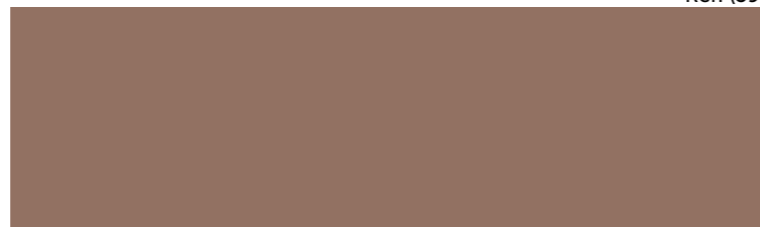

Chocolate

Ref: (60)



Gris

Ref: (61)



Negro

● Les couleurs imprimées présentées ne sont qu'indicatives et peuvent varier par rapport aux couleurs originales et les receveurs.  
● Printed colours are approximate and may vary from originals.





Composition | blanco estatuario | chêne naturel

1	561 56 000	Stoneplus Plan vasque avec haute latérale
1	112 24 104	Module 1 tiroir 100
1	112 24 210	Plateau 100
	422 00 000	poignée Line / chrome
1	262 00 120	Tower 120
1	410 00 101	Siphon

Auxiliaires

1	112 24 435	Colonne haute
---	------------	---------------

Robinet

1	412 00 800	Combi chrome
---	------------	--------------

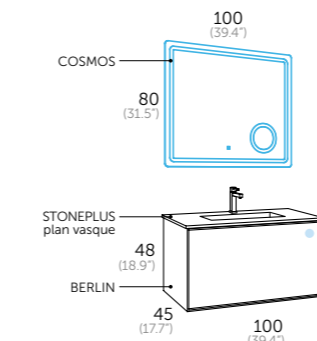
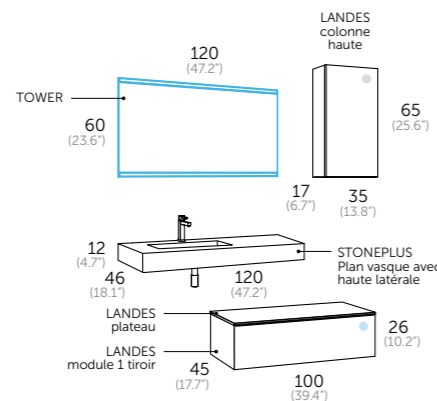

Composition | coffee | blanc mat

1	560 53 000	Stoneplus
1	143 27 100	Berlin 100
1	270 00 100	Cosmos

Robinet

1	412 00 800	Combi cromo
---	------------	-------------

# stoneplus.

## Plan vasque

ref: 560 XX 000

Large

de 61 à 65	1 vasque
de 66 à 75	1 vasque
de 76 à 85	1 vasque
de 86 à 95	1 vasque
de 96 à 105	1 vasque
de 106 à 115	1 vasque
de 116 à 125	1 vasque
de 116 à 125	2 vasques
de 136 à 145	1 vasque
de 136 à 145	2 vasques

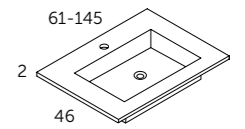

## Plan vasque avec haute latérale

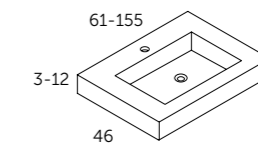

hauteur de 3 à 12 cm

ref: 561 XX 000

Large

de 61 à 65	1 vasque
de 66 à 75	1 vasque
de 76 à 85	1 vasque
de 86 à 95	1 vasque
de 96 à 105	1 vasque
de 106 à 115	1 vasque
de 116 à 125	1 vasque
de 116 à 125	2 vasques
de 126 à 135	1 vasque
de 126 à 135	2 vasques
de 136 à 145	1 vasque
de 136 à 145	2 vasques
de 146 à 155	1 vasque
de 146 à 155	2 vasques

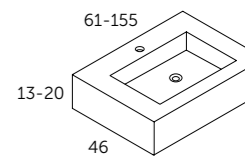

hauteur de 13 à 20 cm

ref: 562 XX 000

Large

de 61 à 65	1 vasque
de 66 à 75	1 vasque
de 76 à 85	1 vasque
de 86 à 95	1 vasque
de 96 à 105	1 vasque
de 106 à 115	1 vasque
de 116 à 125	1 vasque
de 116 à 125	2 vasques
de 126 à 135	1 vasque
de 126 à 135	2 vasques
de 136 à 145	1 vasque
de 136 à 145	2 vasques
de 146 à 155	1 vasque
de 146 à 155	2 vasques

## Escouades invisibles

En option

Mesure	Référence	Prix
43x8	560 00 043	130 €

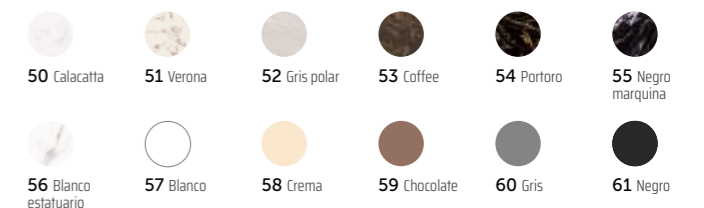

Pour compléter le code, remplacer les XX par le code de la couleur choisie. Il est nécessaire de fournir le plan de l'emplacement de l'élément. Tous ces produits sont disponibles sur commande. Délai de livraison de 20 jours.

To complete the code, replace the XX with the code for your desired colour. A location plan for the inlet will need to be provided. All of these products are available upon request. The lead time for delivery is 20 days.





Composition | negro marquina | blanc mat

1	563 55 000	Átika 140 2v.
2	112 35 074	Module 1 tiroir 70
1	112 35 214	Plateau 140
	422 00 000	poignée Line / chrome
1	262 00 140	Tower 140
2	410 00 101	Siphon

Robinet

2	412 00 800	Combi chrome
---	------------	--------------

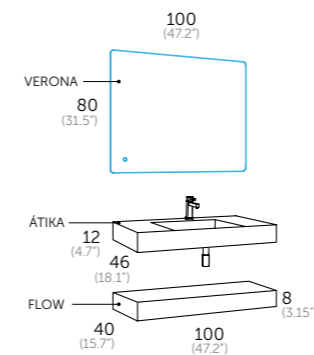
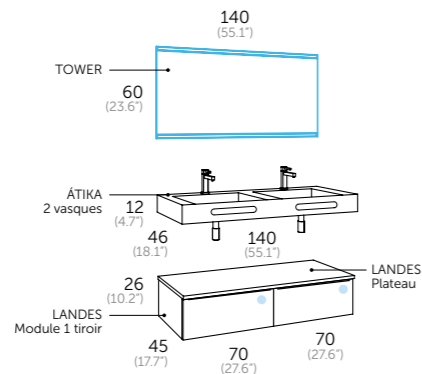

Composition | blanc | pin gris

1	563 57 000	Átika 100
1	138 37 101	Flow 100 f40
1	246 00 100	Verona
1	410 00 101	Siphon

Robinet

1	412 00 800	Combi chrome
---	------------	--------------

# átika.

## Plan vasque avec haute latérale

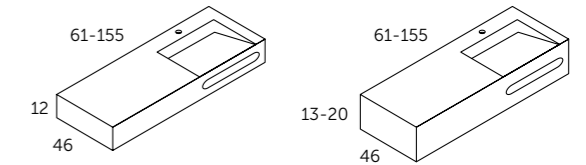

hauteur 12 cm

ref: 563 XX 000

Large

- de 61 à 65
- de 66 à 75
- de 76 à 85
- de 86 à 95
- de 96 à 105
- de 106 à 115
- de 116 à 125
- de 126 à 135
- de 136 à 145
- de 146 à 155

hauteur de 13 à 20 cm

ref: 564 XX 000

Large

- de 61 à 65
- de 66 à 75
- de 76 à 85
- de 86 à 95
- de 96 à 105
- de 106 à 115
- de 116 à 125
- de 126 à 135
- de 136 à 145
- de 146 à 155

Porte-serviettes inclus | Escouades inclus

## Plan vasque 2 vasques avec haute latérale

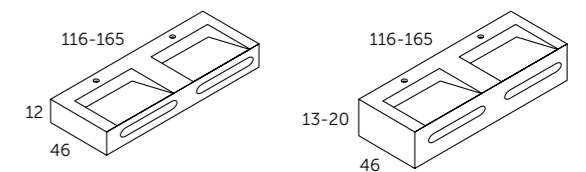

hauteur 12 cm

ref: 563 XX 000

Large

- de 116 à 125
- de 126 à 135
- de 136 à 145
- de 146 à 155
- de 156 à 165

hauteur de 13 à 20 cm

ref: 564 XX 000

Large

- de 116 à 125
- de 126 à 135
- de 136 à 145
- de 146 à 155
- de 156 à 165

Porte-serviettes inclus | Escouades inclus



Pour compléter le code, remplacer les XX par le code de la couleur choisie. Il est nécessaire de fournir le plan de l'emplacement de l'élément. Tous ces produits sont disponibles sur commande. Délai de livraison de 20 jours.  
To complete the code, replace the XX with the code for your desired colour. A location plan for the inlet will need to be provided. All of these products are available upon request. The lead time for delivery is 20 days.





Perse | 59.5 x 26 x 45 | Gris polar



Perse | 59.5 x 26 x 45 | Crema



Kish | 102 x 30 x 46 | Calacatta



Petra | 80 x 12 x 45 | Blanco estuario



Kish | 102 x 30 x 46 | Gris



## perse.

### Plan vasque

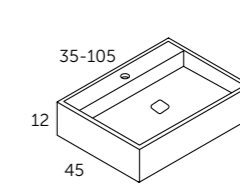

hauteur 12 cm

ref: **565 XX 000**

Large

de 35 à 55

de 56 à 65

de 66 à 75

de 76 à 85

de 86 à 95

de 96 à 105

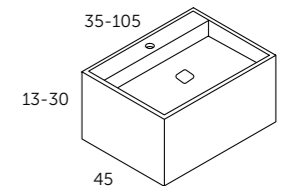

hauteur de 13 à 30 cm

ref: **566 XX 000**

Large

de 35 à 55

de 56 à 65

de 66 à 75

de 76 à 85

de 86 à 95

de 96 à 105

## petra.

### Plan vasque

profondeur 35 cm

ref: **567 XX 000**

Large

de 35 à 55

de 56 à 65

de 66 à 75

de 76 à 85

de 86 à 95

de 96 à 105

de 106 à 115

de 116 à 125

de 126 à 135

de 136 à 145

de 146 à 155

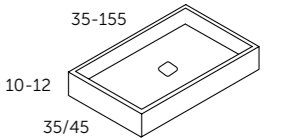

profondeur 45 cm

ref: **568 XX 000**

Large

de 35 à 55

de 56 à 65

de 66 à 75

de 76 à 85

de 86 à 95

de 96 à 105

de 106 à 115

de 116 à 125

de 126 à 135

de 136 à 145

de 146 à 155

## kish.

### Plan vasque

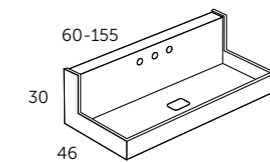

ref: **569 XX 000**

Large

de 60 à 65

de 66 à 75

de 76 à 85

de 86 à 95

de 96 à 105

de 106 à 115

de 116 à 125

de 126 à 135

de 136 à 145

de 146 à 155

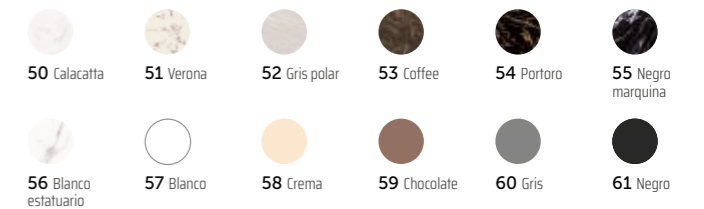

Pour compléter le code, remplacer les XX par le code de la couleur choisie. Il est nécessaire de fournir le plan de l'emplacement de l'élément. Tous ces produits sont disponibles sur commande. Délai de livraison de 20 jours.

To complete the code, replace the XX with the code for your desired colour. A location plan for the inlet will need to be provided. All of these products are available upon request. The lead time for delivery is 20 days.



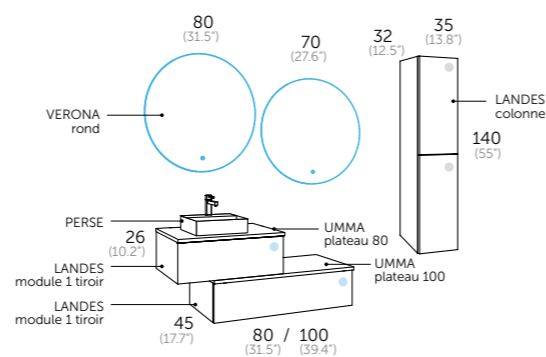

Composition | negro marquina | negro | chène naturel

1	112 24 083	Module 1 tiroir 80 et organisateur
1	570 55 000	Umma plateau 80
1	112 24 104	Module 1 tiroir 100
1	570 55 000	Umma plateau 100
	422 02 000	poignée Line / noir
1	565 61 000	Perse
1	247 00 080	Verona rond 80
1	247 00 070	Verona rond 70

Auxiliaires

1	112 24 336	Colonne droite
---	------------	----------------



Robinet

1	412 00 800	Combi chrome
---	------------	--------------

# umma.

## Plateaux

hauteur 2 cm

ref: 570 XX 000

Large	
de 40 à 65	1 vasque
de 66 à 75	1 vasque
de 76 à 85	1 vasque
de 86 à 95	1 vasque
de 96 à 105	1 vasque
de 106 à 115	1 vasque
de 116 à 125	1 vasque
de 116 à 125	2 vasques
de 126 à 135	1 vasque
de 126 à 135	2 vasques
de 136 à 145	1 vasque
de 136 à 145	2 vasques
de 146 à 155	1 vasque
de 146 à 155	2 vasques

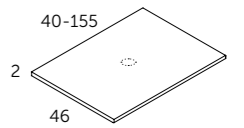

## Plateaux avec haute latérale

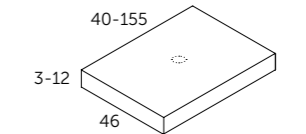

hauteur de 3 à 12 cm

ref: 571 XX 000

Large	
de 40 à 65	1 vasque
de 66 à 75	1 vasque
de 76 à 85	1 vasque
de 86 à 95	1 vasque
de 96 à 105	1 vasque
de 106 à 115	1 vasque
de 116 à 125	1 vasque
de 116 à 125	2 vasques
de 126 à 135	1 vasque
de 126 à 135	2 vasques
de 136 à 145	1 vasque
de 136 à 145	2 vasques
de 146 à 155	1 vasque
de 146 à 155	2 vasques

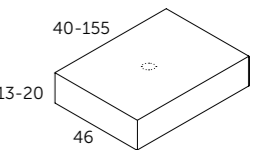

hauteur de 13 à 20 cm

ref: 572 XX 000

Large	
de 40 à 65	1 vasque
de 66 à 75	1 vasque
de 76 à 85	1 vasque
de 86 à 95	1 vasque
de 96 à 105	1 vasque
de 106 à 115	1 vasque
de 116 à 125	1 vasque
de 116 à 125	2 vasques
de 126 à 135	1 vasque
de 126 à 135	2 vasques
de 136 à 145	1 vasque
de 136 à 145	2 vasques
de 146 à 155	1 vasque
de 146 à 155	2 vasques

## Escuades invisibles

En option

Mesurer	Référence
43x8	560 00 043

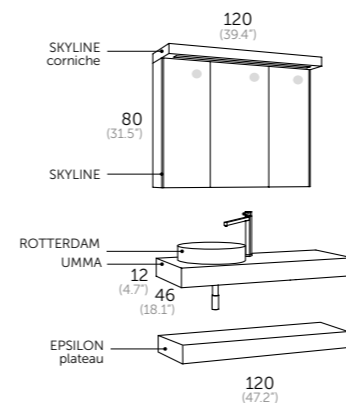

Composition | blanco estatuario | ocean

1	571 56 000	Umma 120
1	594 32 121	Epsilon plateau
1	341 35 120	Skyline
1	341 35 121	Corniche
1	507 01 004	Rotterdam
1	410 00 101	Siphon

Robinet

1	412 00 805	Combi élevé chrome
---	------------	--------------------

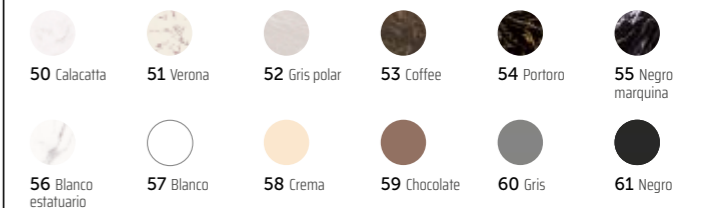

Pour compléter le code, remplacer les XX par le code de la couleur choisie. Il est nécessaire de fournir le plan de l'emplacement de l'élément. Tous ces produits sont disponibles sur commande. Délai de livraison de 20 jours.

To complete the code, replace the XX with the code for your desired colour. A location plan for the inlet will need to be provided. All of these products are available upon request. The lead time for delivery is 20 days.





Plateau stone.tec | 120 x 1,5 x 46  
Vasque à poser Coliseum | Verde claro mat



Plateaux avec haute latérale stone.tec | 100 x 10 x 46  
Vasque à poser Trevi | Azul indico mat

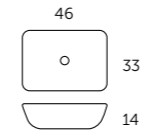

**trevi**  
Vasque à poser céramique émaillé

Mesurer	Référence
33x46	579 XX 046

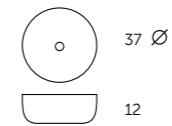

**coliseum**  
Vasque à poser céramique émaillé

Mesurer	Référence
37	578 XX 037

Ref: (65)

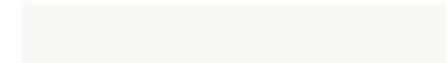

Blanco mat Ref: (69)



Hormigón mat Ref: (62)



Azier mat Ref: (64)



Negro mat Ref: (63)



Azul indico mat Ref: (67)



Verde claro mat Ref: (70)



Verde oliva mat Ref: (66)



Capuchino mat Ref: (68)



Fango mat

Les couleurs reproduites sont approximatives et peuvent différer de l'original.  
Printed colours are approximate and may vary from originals.

# stone.tec

Ce nouveau matériau polymère de dernière génération est composé par un mélange de charges minérales à haute pression combiné avec un revêtement synthétique de couleur à base de nanoparticules. Cela lui confère des hautes propriétés antibactériennes, d'imperméabilité et de grande résistance à l'abrasion, aux taches et aux agents chimiques. Le tout avec une finition mate parfaite à la texture douce et soyeuse très facile à nettoyer.

La vaste gamme de couleurs disponibles est idéale pour associer avec tout type de meuble ou lavabo. Son épaisseur principale est de 15 mm, avec la possibilité de pente pour obtenir un profilé allant jusqu'à 200 mm.

This new cutting-edge polymer material is composed of a mixture of high-pressure mineral fillers combined with a synthetic coloured coating made from nanoparticles. This gives it impressive antibacterial properties and makes it highly impermeable and resistant to abrasion, stains and chemical agents. In addition to all of these properties, it also has a perfect matt finish with a texture that is soft and silky and very easy to clean.

The wide range of available colours makes it the perfect range to combine with any kind of sink or furniture. The main thickness is 15 mm, with the potential to add a drop-front edge to achieve a profile of up to 200 mm.

## Plateaux

hauteur 1,5 cm

ref: 575 XX 000

Large

de 61 à 65

de 66 à 75

de 76 à 85

de 86 à 95

de 96 à 105

de 106 à 115

de 116 à 125

de 126 à 135

de 136 à 145

de 146 à 155

de 156 à 161

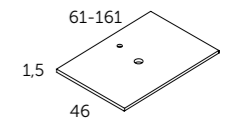

## Plateaux avec haute latérale

hauteur de 2 à 12 cm

ref: 576 XX 000

Large

de 61 à 65

de 66 à 75

de 76 à 85

de 86 à 95

de 96 à 105

de 106 à 115

de 116 à 125

de 126 à 135

de 136 à 145

de 146 à 155

de 156 à 161

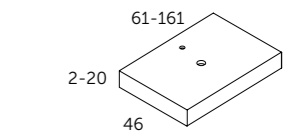

hauteur de 13 à 20 cm

ref: 577 XX 000

Large

de 61 à 65

de 66 à 75

de 76 à 85

de 86 à 95

de 96 à 105

de 106 à 115

de 116 à 125

de 126 à 135

de 136 à 145

de 146 à 155

de 156 à 161

## Escouades invisibles

En option

Mesurer	Référence
43x8	560 00 043



Pour compléter le code, remplacer les XX par le code de la couleur choisie. Il est nécessaire de fournir le plan de l'emplacement de l'élément. Tous ces produits sont disponibles sur commande. Délai de livraison de 20 jours.

To complete the code, replace the XX with the code for your desired colour. A location plan for the inlet will need to be provided. All of these products are available upon request. The lead time for delivery is 20 days.



# spécification techniques

Technical specifications

<b>Plans vasques</b> .....	280
Masai .....	283
Vasque à poser .....	288
Robinetterie .....	290
<b>Miroirs</b> .....	292
Miroirs LED .....	294
Armoires de salle de bain .....	296
<b>Éclairage</b> .....	300
<b>Meubles</b> .....	302
Auxiliaires .....	326
Caractéristiques techniques .....	328
<b>Compléments</b> .....	330
<b>Finitions</b> .....	332

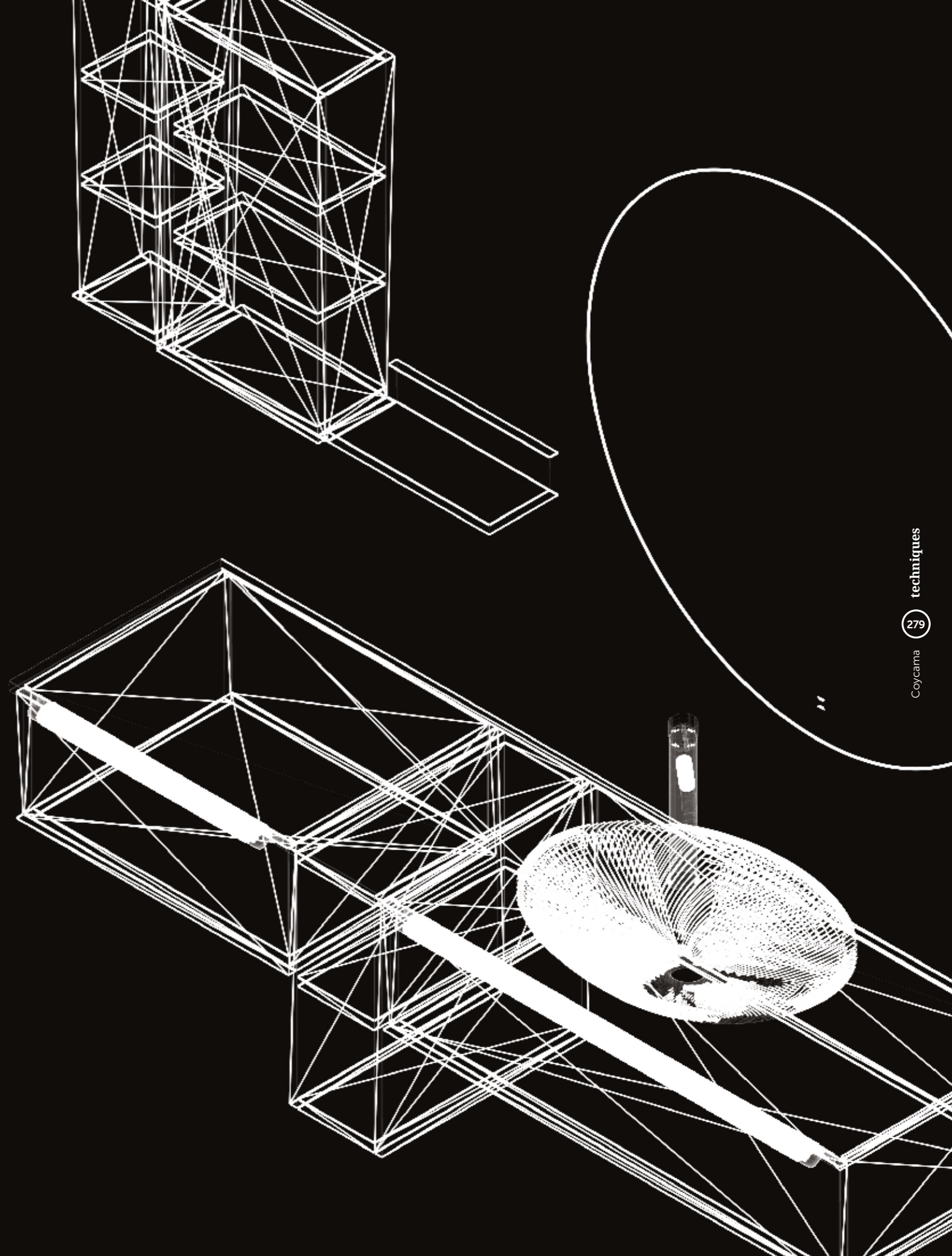

# Plans vasques



## onix new

céramique extraplat

Dimension	Référence
60	550 01 060
70	550 01 070
80	550 01 080
90	550 01 090
100	550 01 100
120	550 01 120
80 (60+20)	550 01 081
90 (70+20)	550 01 091
100 (70+30)	550 01 101
80 (20+60)	550 01 083
90 (20+70)	550 01 093
100 (30+70)	550 01 103
120	550 01 122

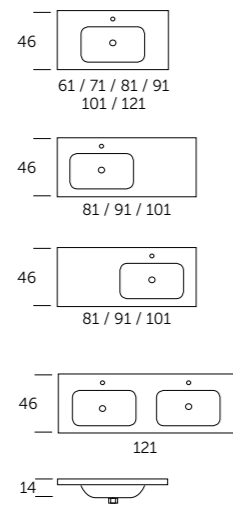

## topacio

resine finition gel coat brillant

Dimension	Référence
60	505 01 060
80	505 01 080
100	505 01 100
120	505 01 120
120	505 01 122
140	505 01 142

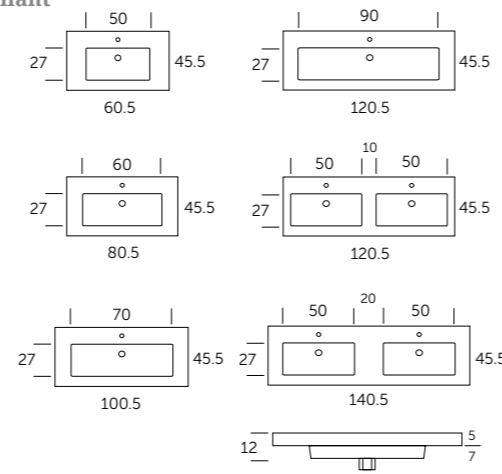

## ambar

solid surface "soft touch" mate

Dimension	Référence
60	506 01 060
70	506 01 070
80	506 01 080
100	506 01 100
120	506 01 120
120	506 01 122
140	506 01 142
80 (60+20)	506 01 081
90 (70+20)	506 01 092
90 (60+30)	506 01 091
100 (70+30)	506 01 107
110 (80+30)	506 01 112
120 (60+60)	506 01 121
140 (70+70)	506 01 143
80 (20+60)	506 01 083
90 (20+70)	506 01 094
90 (30+60)	506 01 093
100 (30+70)	506 01 108
110 (30+80)	506 01 114
120 (60+60)	506 01 123
140 (70+70)	506 01 144

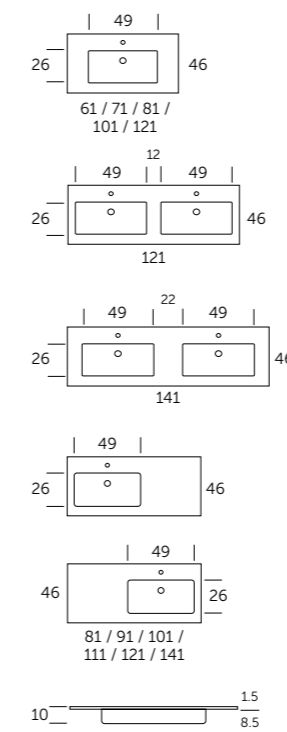

## ambar plateaux

solid surface "soft touch" mate

Dimension	Référence
60	508 01 060
70	508 01 070
80	508 01 080
100	508 01 100
120	508 01 120
140	508 01 140

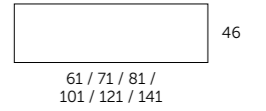

### Option avec porte-serviette

Dimension	Référence
70 (60+10)	508 01 071
80 (70+10)	508 01 081
90 (80+10)	508 01 091
110 (100+10)	508 01 111
130 (120+10)	508 01 131

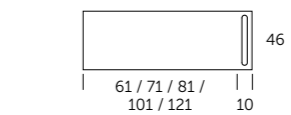

## quattro

céramique

Dimension	Référence
60	521 01 060
80	521 01 080
100	521 01 100

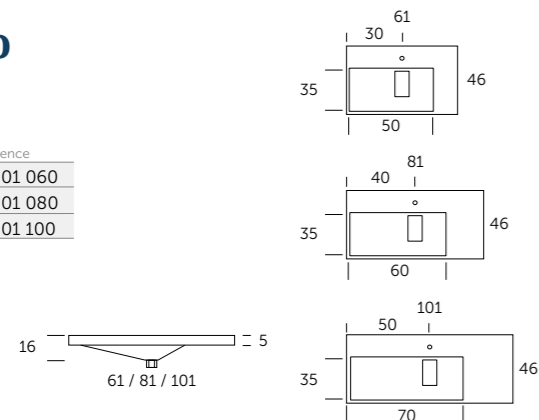

## dama

céramique extraplat

Dimension	Référence
60	503 01 060
80	503 01 080
100	503 01 100
120	503 01 120
120	503 01 122

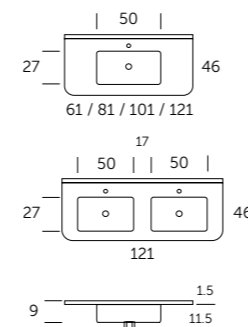

## ambar lip

solid surface "soft touch" mate

Dimension	Référence
80	524 01 080
100	524 01 100
120	524 01 120
80	524 01 081
100	524 01 101
120	524 01 121
Porte-serviettes	
31	524 01 999

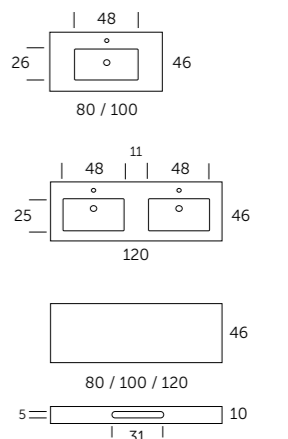



## Plans vasques. profondeur réduite



### onix new f40 céramique extraplat

Dimension	Référence
60	551 01 060
70	551 01 070
80	551 01 080

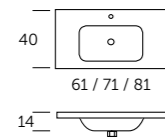

### bali céramique

Dimension	Référence
45x31	515 01 045
55x37	515 01 055

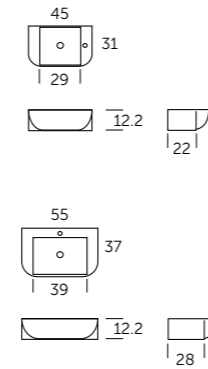

## masai. plan vasque

20 couleurs résine minérale revêtue de polyuréthane acrylique.  
Surface traitement antibactérien.  
Nettoyage facile, peuvent être nettoyés avec quasiment tous les produits d'entretien courants.

Made of 20 colors of mineral-filled polyurethane with acrylic coating.  
Antibacterial treatment area  
Easy cleaning, can be cleaned with almost all usual cleaning products..



Texture lisse  
Smooth finish

Sans trop plein  
Without overflow



### alba céramique

Dimension	Référence
50	510 01 050

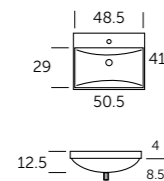

# masai. plan vasque

20 couleurs résine minérale revêtue de polyuréthane acrylique.  
Surface traitement antibactérien.  
Nettoyage facile, peuvent être nettoyés avec quasiment tous les produits d'entretien courants.

Made of 20 colors of mineral-filled polyurethane with acrylic coating.  
Antibacterial treatment area  
Easy cleaning, can be cleaned with almost all usual cleaning products..



Angles arrondis en option  
Plus value: 40€  
Rounded corners options. Increase: 40€

Couleur blanc en stock,  
Autres couleurs sur demande. Délai de livraison 25 jours.  
White colour in stock. Other colors on request.

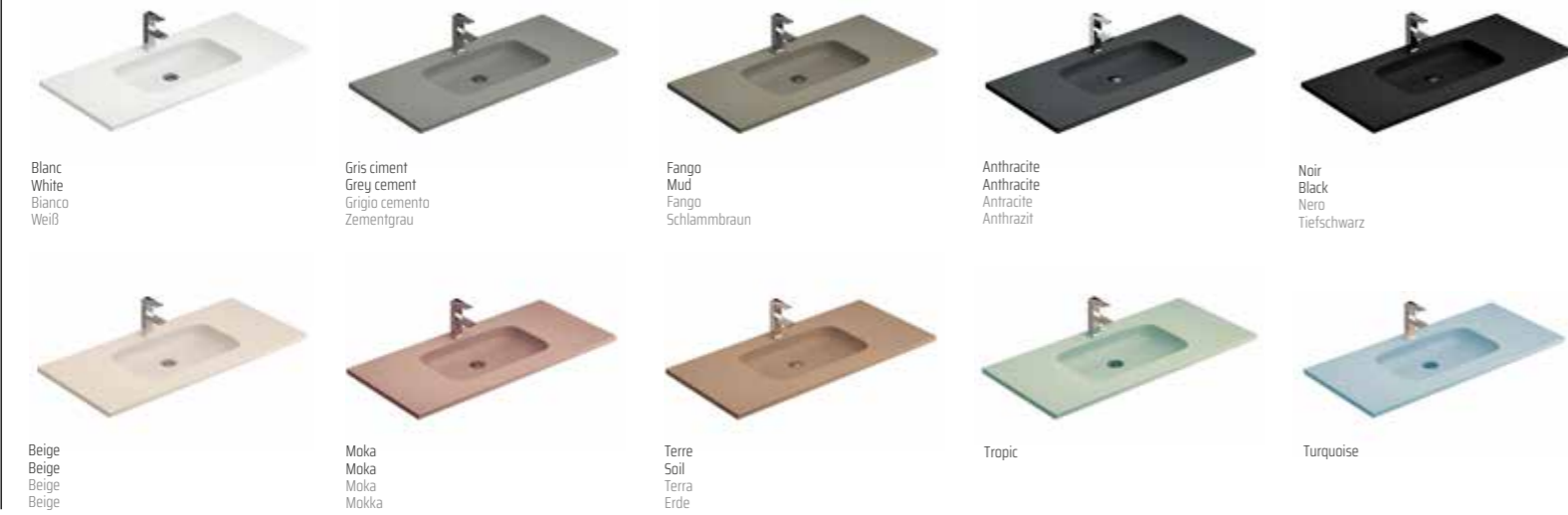

## Métallisé



## Métaux



## masai.60

	Référence*
Blanc	518 01 060
Gris ciment	518 09 060
Fango	518 18 060
Anthracite	518 03 060
Noir	518 02 060
Aubergine	518 11 060
Pourpre	518 12 060
Beige	518 05 060
Moka	518 19 060
Terre	518 20 060
Tropic	518 30 060
Turquoise	518 31 060
Ocean	518 32 060
<b>Métallisé</b>	
Mustard métallisé	518 33 060
Cooper métallisé	518 34 060
Brun métallisé	518 08 060
Noir métallisé	518 04 060
<b>Métaux</b>	
Argent métaux	518 15 060
Or métaux	518 16 060
Plomb métaux	518 17 060

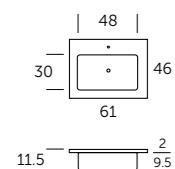

## masai.70

	Référence*
Blanc	518 01 070
Gris ciment	518 09 070
Fango	518 18 070
Anthracite	518 03 070
Noir	518 02 070
Aubergine	518 11 070
Pourpre	518 12 070
Beige	518 05 070
Moka	518 19 070
Terre	518 20 070
Tropic	518 30 070
Turquoise	518 31 070
Ocean	518 32 070
<b>Métallisé</b>	
Mustard métallisé	518 33 070
Cooper métallisé	518 34 070
Brun métallisé	518 08 070
Noir métallisé	518 04 070
<b>Métaux</b>	
Argent métaux	518 15 070
Or métaux	518 16 070
Plomb métaux	518 17 070

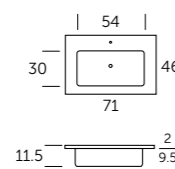

## masai.80

	Référence*
Blanc	518 01 080
Gris ciment	518 09 080
Fango	518 18 080
Anthracite	518 03 080
Noir	518 02 080
Aubergine	518 11 080
Pourpre	518 12 080
Beige	518 05 080
Moka	518 19 080
Terre	518 20 080
Tropic	518 30 080
Turquoise	518 31 080
Ocean	518 32 080
<b>Métallisé</b>	
Mustard métallisé	518 33 080
Cooper métallisé	518 34 080
Brun métallisé	518 08 080
Noir métallisé	518 04 080
<b>Métaux</b>	
Argent métaux	518 15 080
Or métaux	518 16 080
Plomb métaux	518 17 080

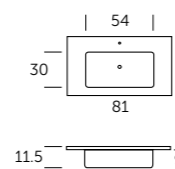

## masai.90

	Référence*
Blanc	518 01 090
Gris ciment	518 09 090
Fango	518 18 090
Anthracite	518 03 090
Noir	518 02 090
Aubergine	518 11 090
Pourpre	518 12 090
Beige	518 05 090
Moka	518 19 090
Terre	518 20 090
Tropic	518 30 090
Turquoise	518 31 090
Ocean	518 32 090
<b>Métallisé</b>	
Mustard métallisé	518 33 090
Cooper métallisé	518 34 090
Brun métallisé	518 08 090
Noir métallisé	518 04 090
<b>Métaux</b>	
Argent métaux	518 15 090
Or métaux	518 16 090
Plomb métaux	518 17 090

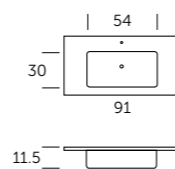

## masai.100

	Référence*
Blanc	518 01 100
Gris ciment	518 09 100
Fango	518 18 100
Anthracite	518 03 100
Noir	518 02 100
Aubergine	518 11 100
Pourpre	518 12 100
Beige	518 05 100
Moka	518 19 100
Terre	518 20 100
Tropic	518 30 100
Turquoise	518 31 100
Ocean	518 32 100
<b>Métallisé</b>	
Mustard métallisé	518 33 100
Cooper métallisé	518 34 100
Brun métallisé	518 08 100
Noir métallisé	518 04 100
<b>Métaux</b>	
Argent métaux	518 15 100
Or métaux	518 16 100
Plomb métaux	518 17 100

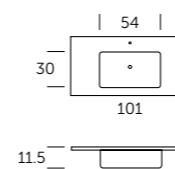

## masai.120.1v

	Référence*
Blanc	518 01 120
Gris ciment	518 09 120
Fango	518 18 120
Anthracite	518 03 120
Noir	518 02 120
Aubergine	518 11 120
Pourpre	518 12 120
Beige	518 05 120
Moka	518 19 120
Terre	518 20 120
Tropic	518 30 120
Turquoise	518 31 120
Ocean	518 32 120
<b>Métallisé</b>	
Mustard métallisé	518 33 120
Cooper métallisé	518 34 120
Brun métallisé	518 08 120
Noir métallisé	518 04 120
<b>Métaux</b>	
Argent métaux	518 15 120
Or métaux	518 16 120
Plomb métaux	518 17 120

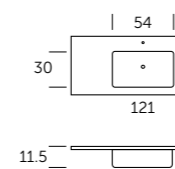

## masai.120.2v

	Référence*
Blanc	518 01 122
Gris ciment	518 09 122
Fango	518 18 122
Anthracite	518 03 122
Noir	518 02 122
Aubergine	518 11 122
Pourpre	518 12 122
Beige	518 05 122
Moka	518 19 122
Terre	518 20 122
Tropic	518 30 122
Turquoise	518 31 122
Ocean	518 32 122
<b>Métallisé</b>	
Mustard métallisé	518 33 122
Cooper métallisé	518 34 122
Brun métallisé	518 08 122
Noir métallisé	518 04 122
<b>Métaux</b>	
Argent métaux	518 15 122
Or métaux	518 16 122
Plomb métaux	518 17 122

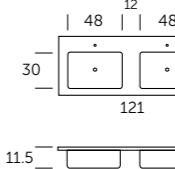

## masai.140

	Référence*
Blanc	518 01 142
Gris ciment	518 09 142
Fango	518 18 142
Anthracite	518 03 142
Noir	518 02 142
Aubergine	518 11 142
Pourpre	518 12 142
Beige	518 05 142
Moka	518 19 142
Terre	518 20 142
Tropic	518 30 142
Turquoise	518 31 142
Ocean	518 32 142
<b>Métallisé</b>	
Mustard métallisé	518 33 142
Cooper métallisé	518 34 142
Brun métallisé	518 08 142
Noir métallisé	518 04 142
<b>Métaux</b>	
Argent métaux	518 15 142
Or métaux	518 16 142
Plomb métaux	518 17 142

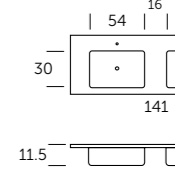

\* Ajouter à la référence pour angles arrondis (C). Plus value: 40€



# masai.plateaux

20 couleurs résine minérale revêtue de polyuréthane acrylique.  
Surface traitement antibactérien.  
Nettoyage facile, peuvent être nettoyés avec quasiment tous les produits d'entretien courants.

Made of 20 colors of mineral-filled polyurethane with acrylic coating.  
Antibacterial treatment area  
Easy cleaning, can be cleaned with almost all usual cleaning products.



Couleur blanc en stock, Autres couleurs sur demande. Délai de livraison 25 jours.  
White colour in stock. Other colors on request.

Les plateaux sont livrés non percés. Facilement percable avec une perceuse à couronne pour le travail du bois.

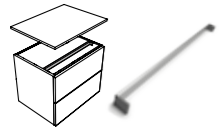
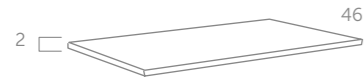

Recommandé l'installation de la barre de renfort. Page 331.



couleur plomb métaux



couleur noir



couleur argent métaux

## Finition texture



Lisse / Ardoise doux  
Smooth / Soft slate finish  
Liscia / Ardesia morbida  
Glatte Oberfläche / Weichschiefer

Blanc White Bianco Weiß	Gris ciment Grey cement Grigio cemento Zementgrau	Fango Mud Fango Schlammbraun	Anthracite Anthracite Antracite Anthrazit	Noir Black Nero Tiefschwarz	Aubergine Aubergine Melanzana Aubergine (Violett)	Pourpre Purple Viola Lila	Mustard métallisé	Cooper métallisé	Argent métaux Metallic silver Argento metallici Metallisch silber	Plomb métaux Metallic lead Piombo metallici Metallisch blei
Beige Beige Beige Beige	Moka Moka Moka Mokka	Terre Soil Terra Erde	Tropic	Turquoise	Ocean	Brun métallisé Metalized brown Marrone metallizzato Metallisch braun	Noir métallisé Metalized black Nero metallizzato Metallisch schwarz	Or métaux Metallic gold Oro metallici Metallisch gold		

## masai.60

Couleur	Référence*
Blanc	519 01 060
Gris ciment	519 09 060
Fango	519 18 060
Anthracite	519 03 060
Noir	519 02 060
Aubergine	519 11 060
Pourpre	519 12 060
Beige	519 05 060
Moka	519 19 060
Terre	519 20 060
Tropic	519 30 060
Turquoise	519 31 060
Ocean	519 32 060
Métallisé	
Mustard métallisé	519 33 060
Cooper métallisé	519 34 060
Brun métallisé	519 08 060
Noir métallisé	519 04 060
Métaux	
Argent métaux	519 15 060
Or métaux	519 16 060
Plomb métaux	519 17 060

## masai.70

Couleur	Référence*
Blanc	519 01 070
Gris ciment	519 09 070
Fango	519 18 070
Anthracite	519 03 070
Noir	519 02 070
Aubergine	519 11 070
Pourpre	519 12 070
Beige	519 05 070
Moka	519 19 070
Terre	519 20 070
Tropic	519 30 070
Turquoise	519 31 070
Ocean	519 32 070
Métallisé	
Mustard métallisé	519 33 070
Cooper métallisé	519 34 070
Brun métallisé	519 08 070
Noir métallisé	519 04 070
Métaux	
Argent métaux	519 15 070
Or métaux	519 16 070
Plomb métaux	519 17 070

## masai.80

Couleur	Référence*
Blanc	519 01 080
Gris ciment	519 09 080
Fango	519 18 080
Anthracite	519 03 080
Noir	519 02 080
Aubergine	519 11 080
Pourpre	519 12 080
Beige	519 05 080
Moka	519 19 080
Terre	519 20 080
Tropic	519 30 080
Turquoise	519 31 080
Ocean	519 32 080
Métallisé	
Mustard métallisé	519 33 080
Cooper métallisé	519 34 080
Brun métallisé	519 08 080
Noir métallisé	519 04 080
Métaux	
Argent métaux	519 15 080
Or métaux	519 16 080
Plomb métaux	519 17 080

## masai.90

Couleur	Référence*
Blanc	519 01 090
Gris ciment	519 09 090
Fango	519 18 090
Anthracite	519 03 090
Noir	519 02 090
Aubergine	519 11 090
Pourpre	519 12 090
Beige	519 05 090
Moka	519 19 090
Terre	519 20 090
Tropic	519 30 090
Turquoise	519 31 090
Ocean	519 32 090
Métallisé	
Mustard métallisé	519 33 090
Cooper métallisé	519 34 090
Brun métallisé	519 08 090
Noir métallisé	519 04 090
Métaux	
Argent métaux	519 15 090
Or métaux	519 16 090
Plomb métaux	519 17 090

## masai.100

Couleur	Référence*
Blanc	519 01 100
Gris ciment	519 09 100
Fango	519 18 100
Anthracite	519 03 100
Noir	519 02 100
Aubergine	519 11 100
Pourpre	519 12 100
Beige	519 05 100
Moka	519 19 100
Terre	519 20 100
Tropic	519 30 100
Turquoise	519 31 100
Ocean	519 32 100
Métallisé	
Mustard métallisé	519 33 100
Cooper métallisé	519 34 100
Brun métallisé	519 08 100
Noir métallisé	519 04 100
Métaux	
Argent métaux	519 15 100
Or métaux	519 16 100
Plomb métaux	519 17 100

## masai.120

Couleur	Référence*
Blanc	519 01 120
Gris ciment	519 09 120
Fango	519 18 120
Anthracite	519 03 120
Noir	519 02 120
Aubergine	519 11 120
Pourpre	519 12 120
Beige	519 05 120
Moka	519 19 120
Terre	519 20 120
Tropic	519 30 120
Turquoise	519 31 120
Ocean	519 32 120
Métallisé	
Mustard métallisé	519 33 120
Cooper métallisé	519 34 120
Brun métallisé	519 08 120
Noir métallisé	519 04 120
Métaux	
Argent métaux	519 15 120
Or métaux	519 16 120
Plomb métaux	519 17 120

## masai.140

Couleur	Référence*
Blanc	519 01 140
Gris ciment	519 09 140
Fango	519 18 140
Anthracite	519 03 140
Noir	519 02 140
Aubergine	519 11 140
Pourpre	519 12 140
Beige	519 05 140
Moka	519 19 140
Terre	519 20 140
Tropic	519 30 140
Turquoise	519 31 140
Ocean	519 32 140
Métallisé	
Mustard métallisé	519 33 140
Cooper métallisé	519 34 140
Brun métallisé	519 08 140
Noir métallisé	519 04 140
Métaux	
Argent métaux	519 15 140
Or métaux	519 16 140
Plomb métaux	519 17 140

## masai.150

Couleur	Référence*
Blanc	519 01 150
Gris ciment	519 09 150
Fango	519 18 150
Anthracite	519 03 150
Noir	519 02 150
Aubergine	519 11 150
Pourpre	519 12 150
Beige	519 05 150
Moka	519 19 150
Terre	519 20 150
Tropic	519 30 150
Turquoise	519 31 150
Ocean	519 32 150
Métallisé	
Mustard métallisé	519 33 150
Cooper métallisé	519 34 150
Brun métallisé	519 08 150
Noir métallisé	519 04 150
Métaux	
Argent métaux	519 15 150
Or métaux	519 16 150
Plomb métaux	519 17 150

## masai.160

Couleur	Référence*
Blanc	519 01 160
Gris ciment	519 09 160
Fango	519 18 160
Anthracite	519 03 160
Noir	519 02 160
Aubergine	519 11 160
Pourpre	519 12 160
Beige	519 05 160
Moka	519 19 160
Terre	519 20 160
Tropic	519 30 160
Turquoise	519 31 160
Ocean	519 32 160
Métallisé	
Mustard métallisé	519 33 160
Cooper métallisé	519 34 160
Brun métallisé	519 08 160
Noir métallisé	519 04 160
Métaux	
Argent métaux	519 15 160
Or métaux	519 16 160
Plomb métaux	519 17 160

## masai.180

Couleur	Référence*
Blanc	519 01 180
Gris ciment	519 09 180
Fango	519 18 180
Anthracite	519 03 180
Noir	519 02 180
Aubergine	519 11 180
Pourpre	519 12 180
Beige	519 05 180
Moka	519 19 180
Terre	519 20 180
Tropic	519 30 180
Turquoise	519 31 180
Ocean	519 32 180
Métallisé	
Mustard métallisé	519 33 180
Cooper métallisé	519 34 180
Brun métallisé	519 08 180
Noir métallisé	519 04 180
Métaux	
Argent métaux	519 15 180
Or métaux	519 16 180
Plomb métaux	519 17 180

## masai.200

Couleur	Référence*
Blanc	519 01 200
Gris ciment	519 09 200
Fango	519 18 200
Anthracite	519 03 200
Noir	519 02 200
Aubergine	519 11 200
Pourpre	519 12 200
Beige	519 05 200
Moka	519 19 200
Terre	519 20 200
Tropic	519 30 200
Turquoise	519 31 200
Ocean	519 32 200
Métallisé	
Mustard métallisé	519 33 200
Cooper métallisé	519 34 200
Brun métallisé	519 08 200
Noir métallisé	519 04 200
Métaux	
Argent métaux	519 15 200
Or métaux	519 16 200
Plomb métaux	519 17 200

\* Ajouter à la référence: Finition en Lisse (L) ou Ardoise Doux (P)

# Vasque à poser



**rotterdam**  
céramique brillant

Dimension	Référence
43	507 01 004

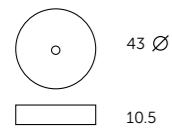

**estambul**  
céramique brillant

Dimension	Référence
50 x 38	507 01 005

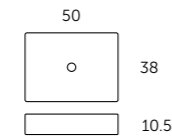

**due**  
céramique brillant

Dimension	Référence
46 x 33	530 01 002

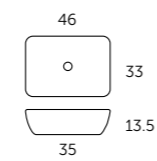

**tre**  
céramique brillant

Dimension	Référence
51 x 35	530 01 035
61 x 35	530 01 036

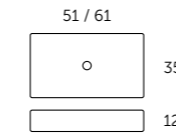

**sei**  
céramique brillant

Dimension	Référence
39 x 39	530 01 006

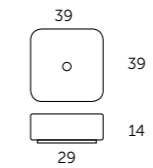

**nove**  
céramique brillant

Dimension	Référence
41 x 42	530 01 094
50 x 42	530 01 095
60 x 42	530 01 096

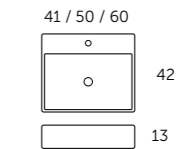

**otto**  
céramique brillant

Dimension	Référence
40	530 01 008

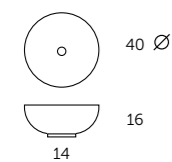

**oval**  
solid surface mate

Dimension	Référence
57 x 41	509 01 001

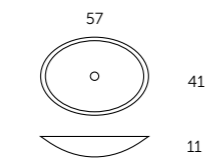

**masai**  
resine

Couleur	Référence
Blanc	518 01 051
Gris ciment	518 09 051
Fango	518 18 051
Anthracite	518 03 051
Noir	518 02 051
Aubergine	518 11 051
Pourpre	518 12 051
Beige	518 05 051
Moka	518 19 051
Terre	518 20 051
Tropic	518 30 051
Turquoise	518 31 051
Ocean	518 32 051
<b>Métallisé</b>	
Mustard métallisé	518 33 051
Cooper métallisé	518 34 051
Brun métallisé	518 08 051
Noir métallisé	518 04 051
<b>Métaux</b>	
Argent métaux	518 15 051
Or métaux	518 16 051
Plomb métaux	518 17 051

20 couleurs résine minérale revêtue de polyuréthane acrylique.  
Surface traitement antibactérien.  
Nettoyage facile, peuvent être nettoyés avec quasiment tous les produits d'entretien courants.

Made of 20 colors of mineral-filled polyurethane with acrylic coating.  
Antibacterial treatment area  
Easy cleaning, can be cleaned with almost all usual cleaning products.

 Couleurs blanc et noir en stock. Autres couleurs sur demande. Délai de livraison 25 jours.  
White and black colour in stock. Other colors on request.

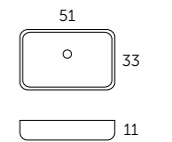



# Robinetterie

# Nouveau combi.robinet

Disponible en finition chrome, chêne naturel et dans 20 autres couleurs Masai.  
Available in chrome finish, natural oak and 20 other Masai colors.



Couleurs chrome et Chêne naturel en stock. Autres couleurs sur demande. Délai de livraison 25 jours  
Chrome and natural oak colors in stock. Other colors on request.

## málaga

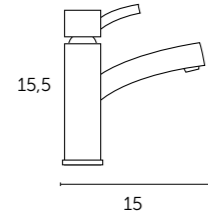

Référence  
414 00 211

- Flexibles CSTB
- ACS
- Vidage à tirette fourni

## sevilla

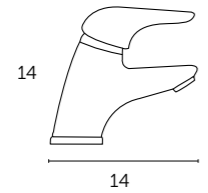

Référence  
414 00 067

- Flexibles CSTB
- ACS
- Vidage non fourni

## combi.chrome / couleur

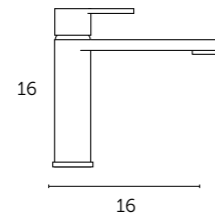

- Flexibles CSTB
- ACS

Couleur	Référence
Chrome	412 00 800
Chêne naturel	412 24 800
<b>Couleur Masai</b>	
Blanc	412 01 800
Gris ciment	412 09 800
Fango	412 18 800
Anthracite	412 03 800
Noir	412 02 800
Aubergine	412 11 800
Pourpre	412 12 800
Beige	412 05 800
Moka	412 19 800
Terre	412 20 800
Tropic	412 30 800
Turquoise	412 31 800
Ocean	412 32 800
<b>Métallisé</b>	
Mustard métallisé	412 33 800
Cooper métallisé	412 34 800
Brun métallisé	412 08 800
Noir métallisé	412 04 800
<b>Métaux</b>	
Argent métaux	412 15 800
Or métaux	412 16 800
Plomb métaux	412 17 800

ecotaxe



bouton du robinet couleur Chêne Naturel



bouton du robinet couleur Masai



## combi élevé.chrome / couleur

## valencia

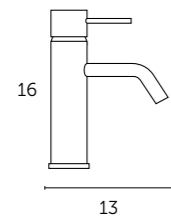

Référence  
414 00 078

- Flexibles CSTB
- ACS
- Double débit eco 50%
- Vidage non fourni

## córdoba

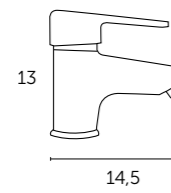

Référence  
414 00 080

- Flexibles CSTB
- ACS
- Double débit eco 50%
- Vidage non fourni

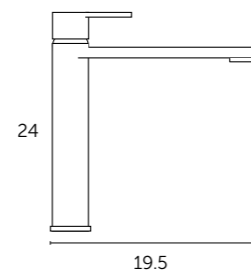

- Flexibles CSTB
- ACS

Couleur	Référence
Chrome	412 00 805
Chêne naturel	412 24 805
<b>Couleur Masai</b>	
Blanc	412 01 805
Gris ciment	412 09 805
Fango	412 18 805
Anthracite	412 03 805
Noir	412 02 805
Aubergine	412 11 805
Pourpre	412 12 805
Beige	412 05 805
Moka	412 19 805
Terre	412 20 805
Tropic	412 30 805
Turquoise	412 31 805
Ocean	412 32 805
<b>Métallisé</b>	
Mustard métallisé	412 33 805
Cooper métallisé	412 34 805
Brun métallisé	412 08 805
Noir métallisé	412 04 805
<b>Métaux</b>	
Argent métaux	412 15 805
Or métaux	412 16 805
Plomb métaux	412 17 805

ecotaxe



bouton du robinet couleur Chêne Naturel



bouton du robinet couleur Masai

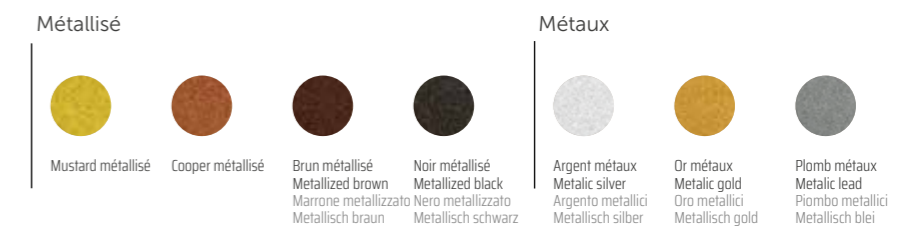

Nos robinets sont fabriqués en Europe.  
Water faucets are manufactured in Europe.

# Miroirs

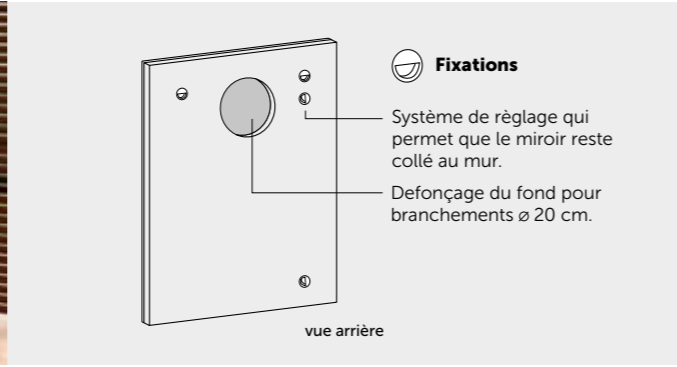

## sun

Dimension	Référence
50 x 80	204 00 050
60 x 80	204 00 060
70 x 80	204 00 070
80 x 80	204 00 080
90 x 80	204 00 090
100 x 80	204 00 100
120 x 80	204 00 120

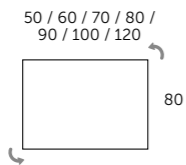

- Epaisseur du verre: 4 mm.
- Monté sur fond bois.
- Réversible.
- Glass thickness: 4 mm.
- Wood background.
- Reversible.



## sigma

Dimension	Référence
80 x 65	290 00 080
100 x 65	290 00 100
120 x 65	290 00 120
140 x 65	290 00 140

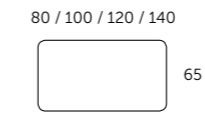

- Epaisseur du verre: 4 mm.
- Fond bois. Defonçage du fond pour branchements.
- Non réversible.
- Glass thickness: 4 mm.
- Wood background with hole for connections.
- Not reversible.



## rond

Dimension	Référence
60	244 00 060
70	244 00 070
80	244 00 080
90	244 00 090
100	244 00 100

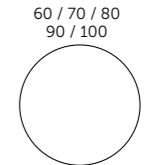

- Epaisseur du verre: 4 mm.
- Glass thickness: 4 mm.



## moon

Dimension	Référence
50 x 68	200 00 050
60 x 68	200 00 060
80 x 68	200 00 080
90 x 68	200 00 090
100 x 68	200 00 100

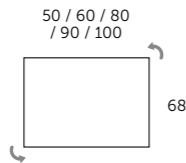

- Epaisseur du verre: 4 mm.
- Réversible.
- Glass thickness: 4mm.
- Reversible.



## tool

Dimension	Référence
Blanc brillant	
60 x 68	207 01 060
80 x 68	207 01 080
100 x 68	207 01 100
Chêne naturel	
60 x 68	207 24 060
80 x 68	207 24 080
100 x 68	207 24 100
Pin gris	
60 x 68	207 37 060
80 x 68	207 37 080
100 x 68	207 37 100

- Epaisseur du verre: 4 mm.
- Monté sur cadre bois finition mélaminé avec texture ou laquée.
- Réversible.
- Glass thickness: 4 mm.
- Mounted on wood frame melamine finish with texture or lacquered.
- Reversible.

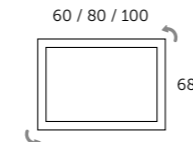

## toscana

Dimension	Référence
Blanc mat	
60 x 80	296 27 060
80 x 80	296 27 080
100 x 80	296 27 100
Chêne naturel	
60 x 80	296 24 060
80 x 80	296 24 080
100 x 80	296 24 100
Pin gris	
60 x 80	296 37 060
80 x 80	296 37 080
100 x 80	296 37 100
Deep blue	
60 x 80	296 18 060
80 x 80	296 18 080
100 x 80	296 18 100

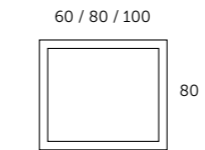

- Epaisseur du verre: 4 mm.
- Non réversible.
- Glass thickness: 4 mm.
- Not reversible.



## nitro

Dimension	Référence
50 x 80	241 00 050

- Epaisseur du verre: 4 mm.
- Réversible.
- Glass thickness: 4 mm.
- Reversible.

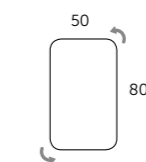

## versa

Dimension	Référence
45 x 70	208 00 045
55 x 70	208 00 055

- Epaisseur du verre: 4 mm.
- Fond bois. Defonçage du fond pour branchements.
- Non réversible.
- Glass thickness: 4 mm.
- Wood background with hole for connections.
- Not reversible.

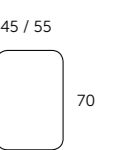



# Miroirs.led



verona

Dimension	Référence
60 x 80	246 00 060
70 x 80	246 00 070
100 x 80	246 00 100
120 x 80	246 00 120
140 x 80	246 00 140

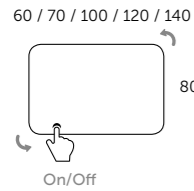

- Système anti buée. Anti fog system. Sistema antiappannamento. Anti Beschlag System. Spiegeilverwarming. نظام ضد الضباب.
- Lumière ambiante. Ambient light. Luce ambiente. Ambient Light. Omgevingslicht. إضاءة خلفية.
- Capteurs de contact. Contact sensor On/Off. Sensore di con tatto On/Off. Sensorschalter On/Off. Aanraken Schakelaar. حساس لمس اطفاء / تشغيل.
- Réversible. It is reversible. Reversibile. Umkehrbar. Omkeerbaar: ja استعمال عكسي.



cosmos

Dimension	Référence
80 x 80	270 00 080
100 x 80	270 00 100
120 x 80	270 00 120

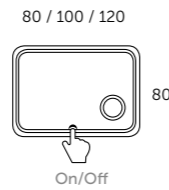

- Système anti buée. Anti fog system. Sistema antiappannamento. Anti Beschlag System. Spiegeilverwarming. نظام ضد الضباب.
- Capteurs de contact. Contact sensor On/Off. Sensore di con tatto On/Off. Sensorschalter On/Off. Aanraken Schakelaar. حساس لمس اطفاء / تشغيل.
- Miroir loupe 3x éclairé. Magnifying zoom in Mirror. Lente d'ingrandimento 3x. Lupe 3x Vergrößerung. Vergrootglas: verhoging x 3. مكبرمراية 3 أضعاف.



tower

Dimension	Référence
80 x 80	262 00 080
100 x 60	262 00 100
120 x 60	262 00 120
140 x 60	262 00 140

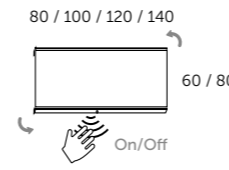

- Système anti buée. Anti fog system. Sistema antiappannamento. Anti Beschlag System. Spiegeilverwarming. نظام ضد الضباب.
- Capteurs de infrarouge. Infrared sensor On/Off. Sensore infrarosso On/Off. Infrarot Sensorschalter On/Off. Infrarood sensor. حساس بلوتوث اطفاء / تشغيل.
- Réversible. It is reversible. Reversibile. Umkehrbar. Omkeerbaar: ja استعمال عكسي.



spoty

Dimension	Référence
80 x 65	267 00 080
100 x 65	267 00 100
120 x 65	267 00 120

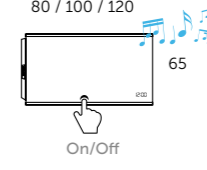

- Capteurs de contact. Contact sensor On/Off. Sensore di con tatto On/Off. Sensorschalter On/Off. Aanraken Schakelaar. حساس لمس اطفاء / تشغيل.
- Montre digitale. Digital clock. Orologio digitale. Digitaluhr. Digitale klok ساعة رقمية.
- Système anti buée. Anti fog system. Sistema antiappannamento. Anti Beschlag System. Spiegeilverwarming. نظام ضد الضباب.
- Lumière ambiante. Ambient light. Luce ambiente. Ambient Light. Omgevingslicht. إضاءة خلفية.



verona rond

Dimension	Référence
70	247 00 070
80	247 00 080
100	247 00 100

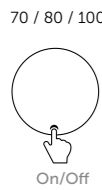

- Système anti buée. Anti fog system. Sistema antiappannamento. Anti Beschlag System. Spiegeilverwarming. نظام ضد الضباب.
- Lumière ambiante. Ambient light. Luce ambiente. Ambient Light. Omgevingslicht. إضاءة خلفية.
- Capteurs de contact. Contact sensor On/Off. Sensore di con tatto On/Off. Sensorschalter On/Off. Aanraken Schakelaar. حساس لمس اطفاء / تشغيل.



rain

Dimension	Référence
60 x 80	269 00 060
70 x 80	269 00 070
80 x 80	269 00 080
100 x 80	269 00 100
120 x 80	269 00 120

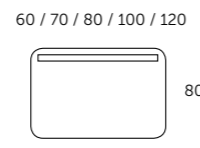

módena

Dimension	Référence
80 x 65	264 00 080
100 x 65	264 00 100

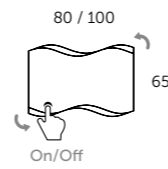

- Système anti buée. Anti fog system. Sistema antiappannamento. Anti Beschlag System. Spiegeilverwarming. نظام ضد الضباب.
- Lumière ambiante. Ambient light. Luce ambiente. Ambient Light. Omgevingslicht. إضاءة خلفية.
- Capteurs de contact. Contact sensor On/Off. Sensore di con tatto On/Off. Sensorschalter On/Off. Aanraken Schakelaar. حساس لمس اطفاء / تشغيل.
- Réversible. It is reversible. Reversibile. Umkehrbar. Omkeerbaar: ja استعمال عكسي.



stone

Dimension	Référence
80 x 80	261 00 080

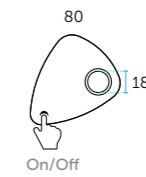

- Système anti buée. Anti fog system. Sistema antiappannamento. Anti Beschlag System. Spiegeilverwarming. نظام ضد الضباب.
- Capteurs de contact. Contact sensor On/Off. Sensore di con tatto On/Off. Sensorschalter On/Off. Aanraken Schakelaar. حساس لمس اطفاء / تشغيل.
- Miroir loupe 3x éclairé. Magnifying zoom in Mirror. Lente d'ingrandimento 3x. Lupe 3x Vergrößerung. Vergrootglas: verhoging x 3. مكبرمراية 3 أضعاف.

Lecteur de musique intégré, connection Bluetooth. 2 Haut-parleurs 3W chacun. Built in music player, bluetooth connection. 2 speakers of 3W each. Lettore musicale integrato, connessione a Bluetooth. 2 altoparlanti 3W ciascuno. Musik Player integriert, Bluetooth Anschluss. 2 Lautsprecher je mit 3W. Muziekspeler. 2 speakers 3W elke. مسجلة داخلية. بلوتوث 2 مكبر صوت 3 واط كل واحد.

## flash. Armoire de toilette

## skyline. Armoire de toilette



- Epaisseur du verre: 3 mm.
- Monté sur des portes de 12 mm.
- Étagères en verre.
- Glass thickness: 3 mm.
- Mounted on a 12 mm door.
- Glass shelves.



### flash.45 (17.7")

Dimension	Référence
Aluminium	340 11 045
(1 porte)	

Ouverture réversible | Reversible opening

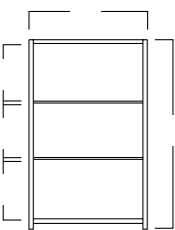
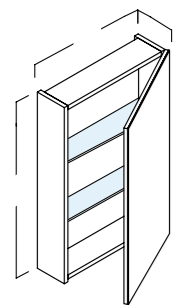

### flash.55 (21.6")

Dimension	Référence
Aluminium	340 11 055
(1 porte)	

Ouverture réversible | Reversible opening

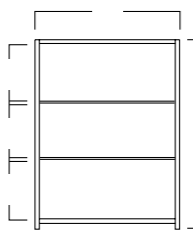
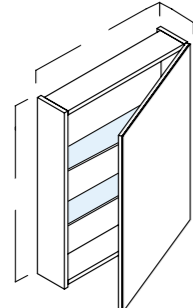

### flash.60 (23.6")

Dimension	Référence
Aluminium	340 11 060
(1 porte)	

Ouverture réversible | Reversible opening

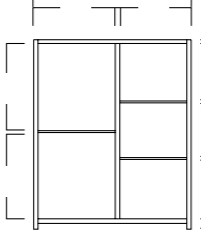
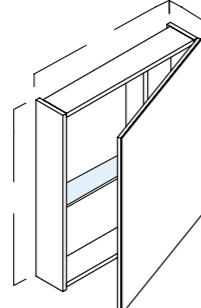

### flash.70 (27.5")

Dimension	Référence
Aluminium	340 11 070
(2 portes)	

Ouverture réversible | Reversible opening

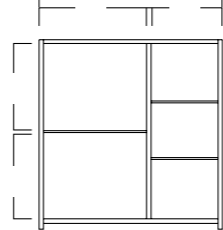
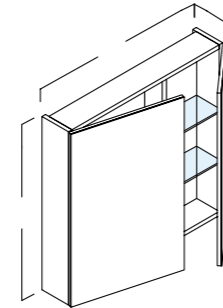

### flash.80 (31.5")

Dimension	Référence
Aluminium	340 11 080
(2 portes)	

Ouverture réversible | Reversible opening

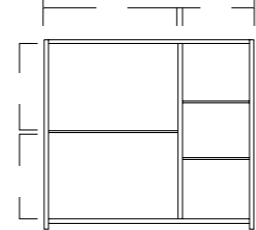
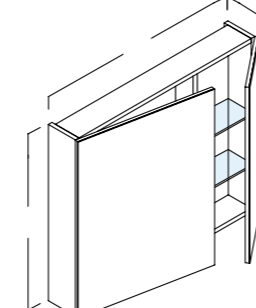

- Étagères en verre.
- Glass shelves.
- Ripiani interni in vetro.
- Glaseinlegeboden.
- Glazen planchets.
- قیچاچز فوفر



- Prise de courant / Interrupteur On-Off.
- Socket / On-Off switch.
- Presa interna / Interruttore On-Off intern.
- Integrierte Steckdose / On-Off Schalter integriert.
- Stopcontact / On-Off schakelaar.
- مأخذ كهرباء / كيسة تشغيل / اطفاء



- Miroir double face.
- Double-faced mirrored doors.
- Ante a doppio specchio.
- Doppelt verspiegelte Türen.
- Twee dubbelzijdig gespiegelde deur.
- أبواب مبرايا داخلية و خارجية



# skyline.

Armoire de toilette

## Éclairage optionnel pour SKYLINE

IP44



skyline.60

Finition	Référence
Blanc mat	341 35 060
Blanc brillant	341 01 060
Chêne nat.	341 24 060
Aluminium	341 11 060
Beige gris brillant	341 16 060
Gris brillant	341 03 060
Beige gris mat	341 46 060
Gris int. mat	341 34 060



skyline.80

Finition	Référence
Blanc mat	341 35 080
Blanc brillant	341 01 080
Chêne nat.	341 24 080
Aluminium	341 11 080
Beige gris brillant	341 16 080
Gris brillant	341 03 080
Beige gris mat	341 46 080
Gris int. mat	341 34 080



skyline.100

Finition	Référence
Blanc mat	341 35 100
Blanc brillant	341 01 100
Chêne nat.	341 24 100
Aluminium	341 11 100
Beige gris brillant	341 16 100
Gris brillant	341 03 100
Beige gris mat	341 46 100
Gris int. mat	341 34 100



skyline.120

Finition	Référence
Blanc mat	341 35 120
Blanc brillant	341 01 120
Chêne nat.	341 24 120
Aluminium	341 11 120
Beige gris brillant	341 16 120
Gris brillant	341 03 120
Beige gris mat	341 46 120
Gris int. mat	341 34 120

## skyline.corniche LED



### 60 cm

Finition	Référence
Blanc mat	341 35 061
Blanc brillant	341 01 061
Chêne Nat.	341 24 061
Aluminium	341 11 061
Beige gris b.	341 16 061
Gris brillant	341 03 061
Beige gris mat	341 46 061
Gris int. mat	341 34 061

### 80 cm

Finition	Référence
Blanc mat	341 35 081
Blanc brillant	341 01 081
Chêne Nat.	341 24 081
Aluminium	341 11 081
Beige gris b.	341 16 081
Gris brillant	341 03 081
Beige gris mat	341 46 081
Gris int. mat	341 34 081

### 100 cm

Finition	Référence
Blanc mat	341 35 101
Blanc brillant	341 01 101
Chêne Nat.	341 24 101
Aluminium	341 11 101
Beige gris b.	341 16 101
Gris brillant	341 03 101
Beige gris mat	341 46 101
Gris int. mat	341 34 101

### 120 cm

Finition	Référence
Blanc mat	341 35 121
Blanc brillant	341 01 121
Chêne Nat.	341 24 121
Aluminium	341 11 121
Beige gris b.	341 16 121
Gris brillant	341 03 121
Beige gris mat	341 46 121
Gris int. mat	341 34 121

## skyline.LED + Haut-parleur Bluetooth



Dimension	Référence
60	400 00 511
80	400 00 521
100	400 00 531
120	400 00 541

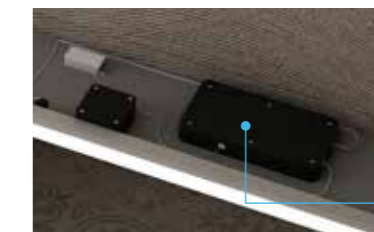

Haut-parleurs Bluetooth connection avec smart phone.  
Bluetooth speakers connection with smart phone.



## appliques.LED



### esther.30



Dimension	Kelvin	Référence
30	6000	400 00 121
30	3000	400 00 221

### sofia.60



Dimension	Kelvin	Référence
60	6000	400 00 141
60	3000	400 00 241

Tous les modèles disponibles, dans la section des appliques.

### Couleurs disponibles

Blanc mat Matte white Bianco opaco Weiß matt Mat wit أبيض مت	Blanc brillant Glossy white Bianco lucido Weiss hochglanz Witte glans أبيض لمع	Chêne naturel Natural oak Rovere naturale Natureiche Naturale eiken بلوط طبيعي	Aluminium Aluminium Alumimio Aluminium Aluminium مونيوم	Beige gris brillant Glossy Mink Tortora lucido Graubeige hochglanz Nerts glans مينك لمع	Gris brillant Glossy grey Grigio lucido Gru hochglanz Grijs glans رمادي لمع	Beige gris mat Matte mink Tortora opaco Graubeige matt Nerts mat مينك مت	Gris intense mat Matte dark grey Grigio intenso opaco Gru intensiv matt Intens mat grijs رمادي مت غامق

# Éclairage.led

IP44 | 230V-50Hz



**nerea mat.30**  
5.5w | 350 lumens

Kelvin	Référence
<b>Lumière Froide / Cool Light</b>	
6000	400 14 161

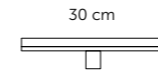

Cadre en bois

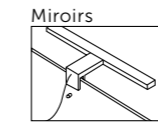
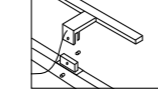

**esther.30**  
5w | 400 lumens

Kelvin	Référence
<b>Lumière Froide / Cool Light</b>	
6000	400 00 121
<b>Lumière Chaude / Warm Light</b>	
3000	400 00 221

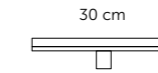

Cadre en bois

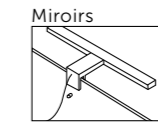
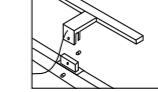

**sofia.60**  
6.5w | 600 lumens

Kelvin	Référence
<b>Lumière Froide / Cool Light</b>	
6000	400 00 141
<b>Lumière Chaude / Warm Light</b>	
3000	400 00 241



Cadre en bois

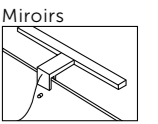
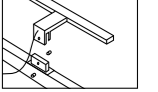

**nikita**  
10w | 1870 lumens | ABS

Kelvin	Référence
<b>Lumière Froide / Cool Light</b>	
5700	400 01 171

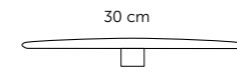

**nayra blanc**  
6w | 780 lumens

Kelvin	Référence
<b>Lumière Froide / Cool Light</b>	
5700	400 00 181

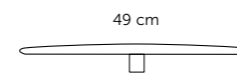

**ainhua.74**  
12w | 800 lumens

Kelvin	Référence
<b>Lumière Froide / Cool Light</b>	
6000	400 00 151

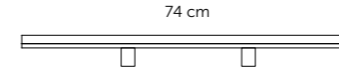

Cadre en bois

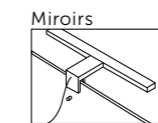
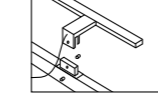

**esther black.30**  
5w | 400 lumens

Kelvin	Référence
<b>Lumière Froide / Cool Light</b>	
6000	400 02 121

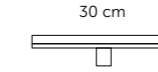

Cadre en bois

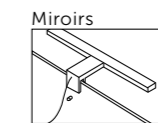
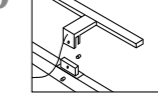

**esther black.45**  
5w | 400 lumens

Kelvin	Référence
<b>Lumière Froide / Cool Light</b>	
6000	400 02 191

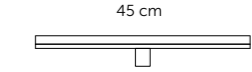

Cadre en bois

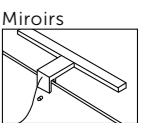
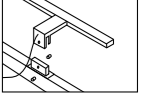

**eva**  
6w

Kelvin	Référence
<b>Lumière Froide / Cool Light</b>	
4000	400 00 011

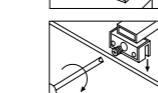
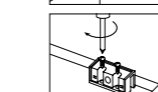
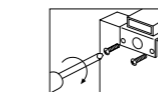

**ursula**  
0.42w | 42 lumens | IP20

Kelvin	Référence
<b>Lumière Froide / Cool Light</b>	
7000	400 00 600







# landes.

Résistant à l'eau.  
Resistant to water.



- Glissières métalliques. Metal interior drawers. Sistema di estrazione metallico. Metallizierleiste. Metalen zijkanen. درج معدني
- Extraction e. extraction. Estrazione e. Komplet herausziehbar. Volledig uittrekbaar. لمآك جرد حرتف ماظن
- Fermeture ralentie. Soft close. Frenata soft close. Sanfter Verschluss. Zachtsluitend. نظام إغلاق التوماتيكي
- Organisateur. Organizer unit. Organizzatore. Obere Ablage. Superieure organizer. منظم درج علوي
- Glissières Hettich. Hettich sliding system. Guide Hettich. Korpussschiene Hettich. Hettich lade system. مفصلات المانيرة هيتش
- Mélamine structurée. Textured melamine. Melamina testurizzata. Textur mit Relief. Reliefstruktur. ملمس منقوش
- Résistant à l'eau. Resistant to water. Idrorepellente. Wasserfest. مقاوم للماء

PREMIUM QUALITY  
★★★★★

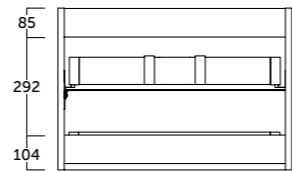

Façades 19 mm / Latérale 19 mm.  
19 mm front / 19 mm side panels.

## landes.60 (23.6")

Finition	Référence
Blanc mat	112 35 060
Chêne naturel	112 24 060
Pin gris	112 37 060
Anthracite mat	112 45 060

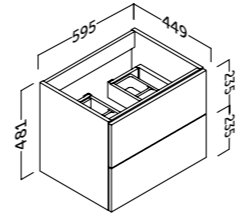

## landes.70 (27.5")

Finition	Référence
Blanc mat	112 35 070
Chêne naturel	112 24 070
Pin gris	112 37 070
Anthracite mat	112 45 070

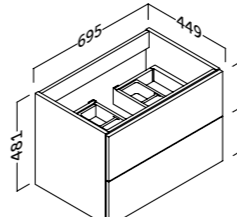

## landes.80 (31.5")

Finition	Référence
Blanc mat	112 35 080
Chêne naturel	112 24 080
Pin gris	112 37 080
Anthracite mat	112 45 080

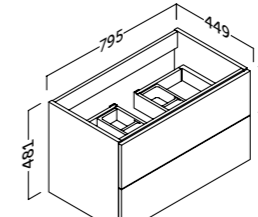

## landes.100 (39.4")

Finition	Référence
Blanc mat	112 35 100
Chêne naturel	112 24 100
Pin gris	112 37 100
Anthracite mat	112 45 100

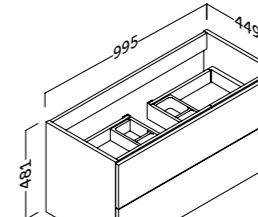

## landes.120 (47.2")

Finition	Référence
Blanc mat	112 35 120
Chêne naturel	112 24 120
Pin gris	112 37 120
Anthracite mat	112 45 120

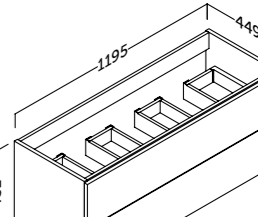

## Nouvelle génération de panneaux plus résistant à l'eau.

New generation of more resistant to water board.



## Système d'extraction de tiroir.

Drawers with extraction.

## landes.plateaux

cm	Blanc mat	Chêne naturel	Pin Gris	Anthracite mat
60	112 35 206	112 24 206	112 37 206	112 45 206
70	112 35 207	112 24 207	112 37 207	112 45 207
80	112 35 208	112 24 208	112 37 208	112 45 208
90	112 35 209	112 24 209	112 37 209	112 45 209
100	112 35 210	112 24 210	112 37 210	112 45 210
110	112 35 211	112 24 211	112 37 211	112 45 211
120	112 35 212	112 24 212	112 37 212	112 45 212
130	112 35 213	112 24 213	112 37 213	112 45 213
140	112 35 214	112 24 214	112 37 214	112 45 214
150	112 35 215	112 24 215	112 37 215	112 45 215
160	112 35 216	112 24 216	112 37 216	112 45 216
180	112 35 218	112 24 218	112 37 218	112 45 218
200	112 35 220	112 24 220	112 37 220	112 45 220

centimètre linéaire (Sur demande. Délai de livraison 25 jours.)

112 35 999	112 24 999	112 37 999	112 45 999
------------	------------	------------	------------

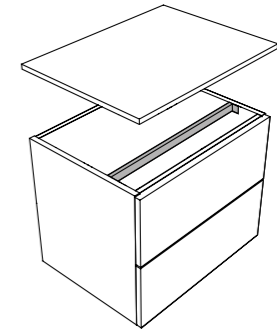
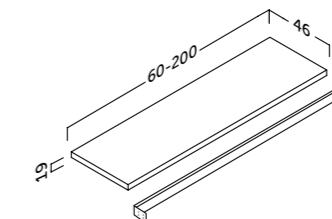

## barre de renfort en aluminium incluse avec landes plateaux

## 3 poignées et 3 couleurs en option

3 handles and 3 colors to choose from.

- Blanc
- Chrome
- Noir

### Bend



### Tilt



### Line



## landes.colonne

Finition	Référence
Blanc mat	112 35 336 112 35 337
Chêne naturel	112 24 336 112 24 337
Pin gris	112 37 336 112 37 337
Anthracite	112 45 336 112 45 337



Porte supérieure:  
Ouverture par poussée. Push to open.  
Sistema Push. Öffnung auf Druck.  
Push to open. باب دفع



Porte basse:  
Fermeture ralentie. Soft close.  
Frenata soft close. Sanfter Verschluss.  
Zachtsluitend. نظام إغلاق التوماتيكي

L'étagère en verre peut changer de position +/- 64 mm  
The glass shelf can change the position +/- 64 mm

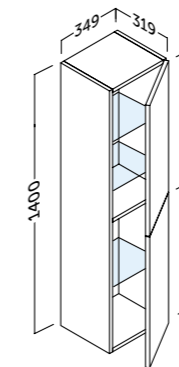

## landes.colonne haute

Finition	Référence
Blanc mat	112 35 435
Chêne naturel	112 24 435
Pin gris	112 37 435
Anthracite	112 45 435

Ouverture réversible | Reversible opening



Ouverture par poussée. Push to open.  
Sistema Push. Öffnung auf Druck.  
Push to open. باب دفع



Ouverture réversible. Reversible opening.  
Apertura reversibile. Reversible Öffnung.  
Omkeerbare opening. فتح عكسها

L'étagère en verre peut changer de position +/- 32 mm  
The glass shelf can change the position +/- 32 mm

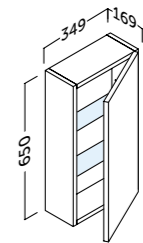

MADE IN SPAIN

# landes. MODULAR

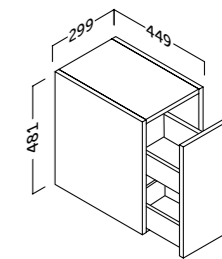
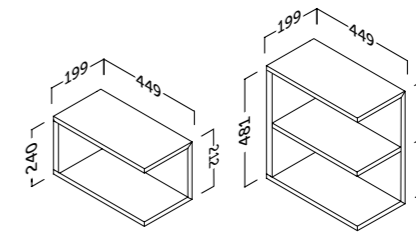
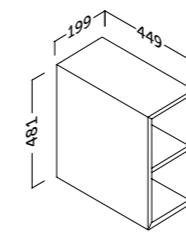
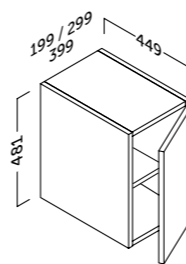
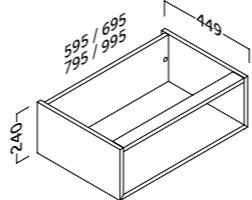
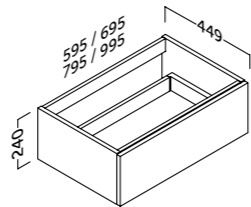
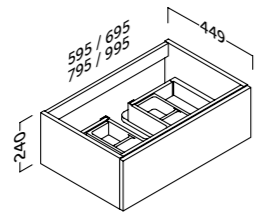
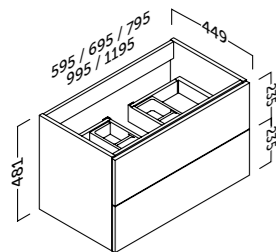

## Module 2 tiroirs

### 60 (23.6")

Finition	Référence
○ Blanc mat	112 35 060
● Chêne naturel	112 24 060
● Pin gris	112 37 060
● Anthracite mat	112 45 060

### 70 (27.5")

Finition	Référence
○ Blanc mat	112 35 070
● Chêne naturel	112 24 070
● Pin gris	112 37 070
● Anthracite mat	112 45 070

### 80 (31.5")

Finition	Référence
○ Blanc mat	112 35 080
● Chêne naturel	112 24 080
● Pin gris	112 37 080
● Anthracite mat	112 45 080

### 100 (39.4")

Finition	Référence
○ Blanc mat	112 35 100
● Chêne naturel	112 24 100
● Pin gris	112 37 100
● Anthracite mat	112 45 100

### 120 (47.2")

Finition	Référence
○ Blanc mat	112 35 120
● Chêne naturel	112 24 120
● Pin gris	112 37 120
● Anthracite mat	112 45 120



## couvercle siphon optionnel

Il couvre le creux du siphon quand il n'a pas de plan vasque.  
Covers the siphon hole when it does not have a washbasin.

Référence  
418 00 000

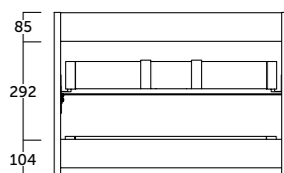

## Module 1 tiroir siphon trou et organisateur

### 60 (23.6")

Finition	Référence
○ Blanc mat	112 35 063
● Chêne naturel	112 24 063
● Pin gris	112 37 063
● Anthracite mat	112 45 063

### 70 (27.5")

Finition	Référence
○ Blanc mat	112 35 073
● Chêne naturel	112 24 073
● Pin gris	112 37 073
● Anthracite mat	112 45 073

### 80 (31.5")

Finition	Référence
○ Blanc mat	112 35 083
● Chêne naturel	112 24 083
● Pin gris	112 37 083
● Anthracite mat	112 45 083

### 100 (39.4")

Finition	Référence
○ Blanc mat	112 35 103
● Chêne naturel	112 24 103
● Pin gris	112 37 103
● Anthracite mat	112 45 103



## Module 1 tiroir

### 60 (23.6")

Finition	Référence
○ Blanc mat	112 35 064
● Chêne naturel	112 24 064
● Pin gris	112 37 064
● Anthracite mat	112 45 064

### 70 (27.5")

Finition	Référence
○ Blanc mat	112 35 074
● Chêne naturel	112 24 074
● Pin gris	112 37 074
● Anthracite mat	112 45 074

### 80 (31.5")

Finition	Référence
○ Blanc mat	112 35 084
● Chêne naturel	112 24 084
● Pin gris	112 37 084
● Anthracite mat	112 45 084

### 100 (39.4")

Finition	Référence
○ Blanc mat	112 35 104
● Chêne naturel	112 24 104
● Pin gris	112 37 104
● Anthracite mat	112 45 104

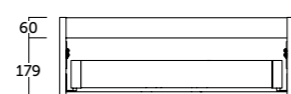

## Module creux

### 60 (23.6")

Finition	Référence
○ Blanc mat	112 35 065
● Chêne naturel	112 24 065
● Pin gris	112 37 065
● Anthracite mat	112 45 065

### 70 (27.5")

Finition	Référence
○ Blanc mat	112 35 075
● Chêne naturel	112 24 075
● Pin gris	112 37 075
● Anthracite mat	112 45 075

### 80 (31.5")

Finition	Référence
○ Blanc mat	112 35 085
● Chêne naturel	112 24 085
● Pin gris	112 37 085
● Anthracite mat	112 45 085

### 100 (39.4")

Finition	Référence
○ Blanc mat	112 35 105
● Chêne naturel	112 24 105
● Pin gris	112 37 105
● Anthracite mat	112 45 105

## Module porte | Réversible

### 20 (7.9")

Finition	Référence
○ Blanc mat	112 35 020
● Chêne naturel	112 24 020
● Pin gris	112 37 020
● Anthracite mat	112 45 020

### 30 (11.8")

Finition	Référence
○ Blanc mat	112 35 030
● Chêne naturel	112 24 030
● Pin gris	112 37 030
● Anthracite mat	112 45 030

### 40 (15.7")

Finition	Référence
○ Blanc mat	112 35 040
● Chêne naturel	112 24 040
● Pin gris	112 37 040
● Anthracite mat	112 45 040

## Module étagère

### 20 (7.9")

Finition	Référence
○ Blanc mat	112 35 022
● Chêne naturel	112 24 022
● Pin gris	112 37 022
● Mint mat	112 28 022
● Dark forest mat	112 29 022
● Anthracite mat	112 45 022

### 21 - 35\* (8,3 - 13,8")

Finition	Référence
○ Blanc mat	112 35 000
● Chêne naturel	112 24 000
● Pin gris	112 37 000
● Mint mat	112 28 000
● Dark forest mat	112 29 000
● Anthracite mat	112 45 000

\*Module étagères fabrication cm à cm. De 21 à 35 cm.  
Sur demande. Délai de livraison 25 jours.

## Module étagère ouverte

### 1 étagère

Finition	Référence
○ Blanc mat	112 35 026
● Chêne naturel	112 24 026
● Pin gris	112 37 026
● Mint mat	112 28 026
● Dark forest mat	112 29 026
● Anthracite mat	112 45 026

### 2 étagères

Finition	Référence
○ Blanc mat	112 35 025
● Chêne naturel	112 24 025
● Pin gris	112 37 025
● Mint mat	112 28 025
● Dark forest mat	112 29 025
● Anthracite mat	112 45 025

## Module double tiroir

### 30 (11.8")

Finition	Référence
○ Blanc mat	112 35 034
● Chêne naturel	112 24 034
● Pin gris	112 37 034
● Anthracite mat	112 45 034

## Auxiliaires.

auxiliary units / armadietti / hängeschränke / aanvullende artikelen / وحدات جانبية

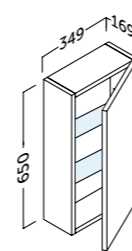

L'étagère en verre peut changer de position +/- 32 mm

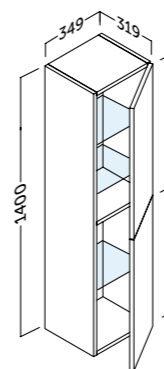

L'étagère en verre peut changer de position +/- 64 mm

## Colonne haute | Réversible

Finition	Référence
○ Blanc mat	112 35 435
● Chêne naturel	112 24 435
● Pin gris	112 37 435
● Anthracite mat	112 45 435

## Colonne

Finition	Droite	Gauche
○ Blanc mat	112 35 336	112 35 337
● Chêne naturel	112 24 336	112 24 337
● Pin gris	112 37 336	112 37 337
● Anthracite mat	112 45 336	112 45 337

## étagère vertical

Finition	Référence
○ Blanc mat	112 35 510
● Chêne naturel	112 24 510
● Pin gris	112 37 510
● Mint mat	112 28 510
● Dark forest mat	112 29 510
● Anthracite mat	112 45 510

## étagère horizontal

Finition	Référence
○ Blanc mat	112 35 505
● Chêne naturel	112 24 505
● Pin gris	112 37 505
● Mint mat	112 28 505
● Dark forest mat	112 29 505
● Anthracite mat	112 45 505

## étagère x3 vertical

Finition	Référence
○ Blanc mat	112 35 500
● Chêne naturel	112 24 500
● Pin gris	112 37 500
● Mint mat	112 28 500
● Dark forest mat	112 29 500
● Anthracite mat	112 45 500

## étagère "L"

Finition	Référence
○ Blanc mat	112 35 520
● Chêne naturel	112 24 520
● Pin gris	112 37 520
● Mint mat	112 28 520
● Dark forest mat	112 29 520
● Anthracite mat	112 45 520

## Poignées

● Chrome ○ Blanc ● Noir

### Bend



Finition	Référence
● Chrome	420 00 000
○ Blanc	420 27 000
● Noir	420 02 000

### Tilt



Finition	Référence
● Chrome	421 00 000
○ Blanc	421 27 000
● Noir	421 02 000

### Line



Finition	Référence
● Chrome	422 00 000
○ Blanc	422 27 000
● Noir	422 02 000



Résistant à l'eau.  
Resistant to water.



# sigma.

- Glissières métalliques. Metal interior drawers. Sistema di estrazione metallico. Metallzierleiste. Metalen zijkanten. درج معدني
- Fermeture ralentie. Soft close. Frenata soft close. Sanfter Verschluss. Zachtsluitend. نظام إغلاق أوتوماتيكي
- Extraction e. extraction. Estrazione e. Komplett herausziehbar. Volledig uittrekbaar. نظام فتح درج كامل
- Glissières Hettich. Hettich sliding system. Guide Hettich. Korpuschiene Hettich. Hettich lade system. مفصلات الجانبيه هيتش
- Laquée mate. Matte lacquered finish. Laccato opaco. Matt lackiert. مات لكر
- Mélamine structuré. Textured melamine. Melamina testurizzata. Textur mit Relief. Reliefstruktur. ملمس منقوش
- Résistant à l'eau. Resistant to water. Idrorepellente. Wasserfest. Waterafstotend. مقاوم للماء

- Suspentes réglables en hauteur et en profondeur avec système anti-décrochement.
- 1 grand tiroir réglable avec côtés métalliques à extraction e et fermeture ralentie silencieuse.
- Caisson renforcé avec un cadre en métal.
- Façades MDF 19 mm / Latérale MDF 19 mm.
- Height and depth adjustable suspension with anti-detachment system.
- 1 large adjustable drawer with metal sides with extraction and silentslow closing. Reinforced case with metal frame.
- 19 mm MDF front / 19 mm MDF side panels.

● 1 siphon extra-plat.

Le bonde est livrée avec le meuble

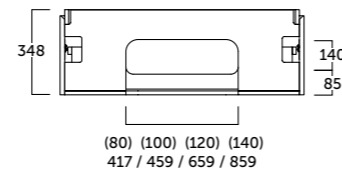

# omega.

Résistant à l'eau.  
Resistant to water.



- Glissières métalliques. Metal interior drawers. Sistema di estrazione metallico. Metallzierleiste. Metalen zijkanten. درج معدني
- Organisateur. Organizer unit. Organizzatore. Obere Ablage. Supérieure organizer. منظم درج علوي
- Fermeture ralentie. Soft close. Frenata soft close. Sanfter Verschluss. Zachtsluitend. نظام إغلاق أوتوماتيكي
- Extraction e. extraction. Estrazione e. Komplett herausziehbar. Volledig uittrekbaar. نظام فتح درج كامل
- Glissières Hettich. Hettich sliding system. Guide Hettich. Korpuschiene Hettich. Hettich lade system. مفصلات الجانبيه هيتش
- Laquée brillant. Glossy lacquered finish. Laccato lucido. Glanzend lackiert. Hoogglans gelakt. لكر لمج
- Laquée mate. Matte lacquered finish. Laccato opaco. Matt lackiert. مات لكر
- Résistant à l'eau. Resistant to water. Idrorepellente. Wasserfest. Waterafstotend. مقاوم للماء

- Suspentes réglables en hauteur et en profondeur avec système anti-décrochement.
- 2 tiroirs réglables cotés métalliques à extraction e et fermeture ralentie.
- Façades MDF 19 mm Finition coins incurvés. Latérale MDF 19 mm.
- Height and depth adjustable suspension with anti-detachment system
- 2 adjustable drawers with metal sides with extraction and silentslow closing. 19 mm MDF fronts and sides edges rounded. 19 mm MDF side panels.

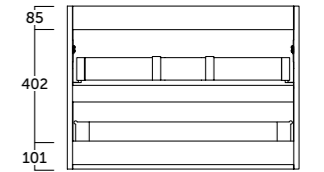

**sigma.80** (31.5")

Finition	Référence
Blanc mat	190 27 080
Gris intense mat	190 34 080
Chêne naturel	190 24 080

**sigma.100** (39.4")

Finition	Référence
Blanc mat	190 27 100
Gris intense mat	190 34 100
Chêne naturel	190 24 100

**sigma.120** (47.2")

Finition	Référence
Blanc mat	190 27 120
Gris intense mat	190 34 120
Chêne naturel	190 24 120

**sigma.140** (55.1")

Finition	Référence
Blanc mat	190 27 140
Gris intense mat	190 34 140
Chêne naturel	190 24 140

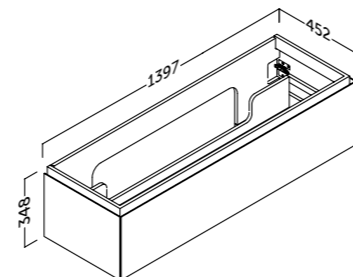
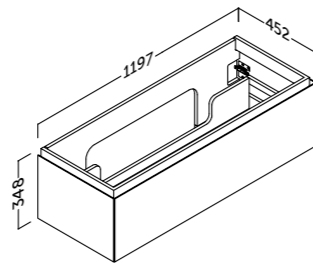
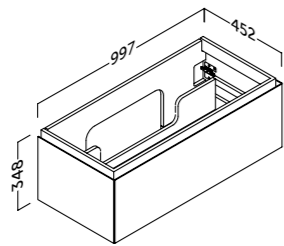
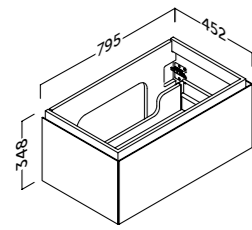

**sigma.colonne**

Finition	Référence
Blanc mat	190 27 340
Gris intense mat	190 34 340
Chêne naturel	190 24 340

**sigma.colonne haute**

Finition	Référence
Blanc mat	190 27 435
Gris intense mat	190 34 435
Chêne naturel	190 24 435

**sigma.organizer**

Référence  
411 00 001

Fermeture ralentie. Soft close. Frenata soft close. Sanfter Verschluss. Zachtsluitend. نظام إغلاق أوتوماتيكي

Ouverture réversible. Reversible opening. Apertura reversibile. Reversible Öffnung. Omkeerbare opening. فتح عكسيها

Optionel

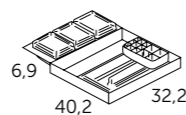

MADE IN SPAIN



**omega.60** (23.6")

Finition brillante	Référence
Blanc brillant	193 01 060
Gris brillant	193 03 060
Beige gris brillant	193 16 060

Finition mat	Référence
Blanc mat	193 27 060
Gris intense mat	193 34 060
Beige gris mat	193 46 060

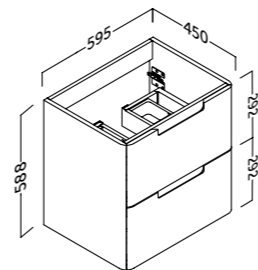

**omega.80** (31.5")

Finition brillante	Référence
Blanc brillant	193 01 080
Gris brillant	193 03 080
Beige gris brillant	193 16 080

Finition mat	Référence
Blanc mat	193 27 080
Gris intense mat	193 34 080
Beige gris mat	193 46 080

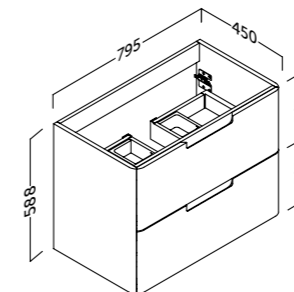

**omega.100** (39.4")

Finition brillante	Référence
Blanc brillant	193 01 100
Gris brillant	193 03 100
Beige gris brillant	193 16 100

Finition mat	Référence
Blanc mat	193 27 100
Gris intense mat	193 34 100
Beige gris mat	193 46 100

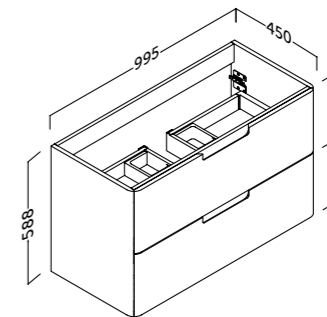

**omega.120** (47.2")

Finition brillante	Référence
Blanc brillant	193 01 120
Gris brillant	193 03 120
Beige gris brillant	193 16 120

Finition mat	Référence
Blanc mat	193 27 120
Gris intense mat	193 34 120
Beige gris mat	193 46 120

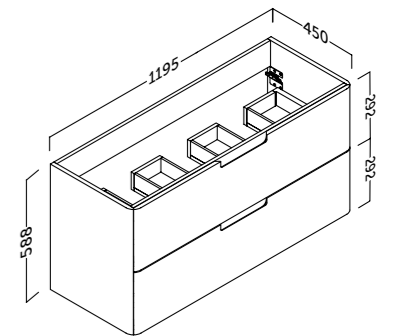

**omega.colonne**

Finition brillante	Référence
Blanc brillant	193 01 335
Gris brillant	193 03 335
Beige gris brillant	193 16 335

Finition mat	Référence
Blanc mat	193 27 335
Gris intense mat	193 34 335
Beige gris mat	193 46 335

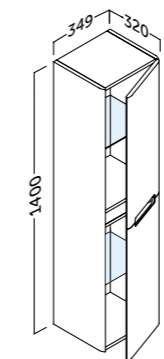

Fermeture ralentie. Soft close. Frenata soft close. Sanfter Verschluss. Zachtsluitend. نظام إغلاق أوتوماتيكي

Ouverture réversible. Reversible opening. Apertura reversibile. Reversible Öffnung. Omkeerbare opening. فتح عكسيها

Ouverture réversible | Reversible opening  
L'étagère en verre peut changer de position +/- 64 mm

MADE IN SPAIN



# berlín.



-  Glissières métalliques. Metal interior drawers. Sistema di estrazione metallico. Metallizerleiste. Metalen zijkanter. درج معدني
-  Organisateur. Organizer unit. Organizzatore. Obere Ablage. Superieure organizer. منظم درج علوي
-  Fermeture ralentie. Soft close. Frenata soft close. Sanfter Verschluss. Zachtsluitend. نظام إغلاق ائوماتيكي
-  Extraction e. extraction. Estrazione e. Komplett herausziehbar. Volledig uittrekbaar. نظام فتح درج كامل
-  Glissières Hettich. Hettich sliding system. Guide Hettich. Korpuschiene Hettich. Hettich lade system. مفصلات المانية هيتش
-  Laquée mate. Matte lacquered finish. Laccato opaco. Matt lackiert. Mat gelakt. لكر مت
-  Mélangé structuré. Textured melamine. Melamina testurizzata. Textur mit Relief. Reliëfstructuur. ملمس منقوش

- Suspentes réglables en hauteur et en profondeur avec système anti-décrochement.
- 2 tiroirs (1 intérieur) réglable avec côtés métalliques à extraction e et fermeture ralentie silencieuse.
- Façades MDF 16 mm / Latérale MDF 16 mm.
- Height and depth adjustable suspension with anti-detachment system.
- 2 adjustable drawers (1 interior) with metal sides with extraction and silentslow closing.
- 16 mm MDF front / 16 mm MDF side panels.

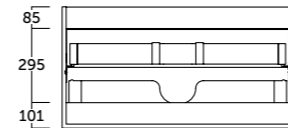

# lúxor.



-  Glissières métalliques. Metal interior drawers. Sistema di estrazione metallico. Metallizerleiste. Metalen zijkanter. درج معدني
-  Organisateur. Organizer unit. Organizzatore. Obere Ablage. Superieure organizer. منظم درج علوي
-  Fermeture ralentie. Soft close. Frenata soft close. Sanfter Verschluss. Zachtsluitend. نظام إغلاق ائوماتيكي
-  Extraction e. extraction. Estrazione e. Komplett herausziehbar. Volledig uittrekbaar. نظام فتح درج كامل
-  Glissières Hettich. Hettich sliding system. Guide Hettich. Korpuschiene Hettich. Hettich lade system. مفصلات المانية هيتش
-  Laquée brillant. Glossy lacquered finish. Laccato lucido. Glanzend lackiert. Hoogglans gelakt. لكر لمع
-  Mélangé structuré. Textured melamine. Melamina testurizzata. Textur mit Relief. Reliëfstructuur. ملمس منقوش

- Suspentes réglables en hauteur et en profondeur avec système anti-décrochement.
- 3 tiroirs réglables cotés métalliques à extraction e et fermeture ralentie.
- Façades MDF 22 mm / Façades Finition blanc MDF 19 mm. Latérale 16 mm.
- Height and depth adjustable suspension with anti-detachment system.
- 3 adjustable drawers with metal sides with extraction and silentslow closing.
- 22 mm MDF front / 19 mm MDF front white finish. 16 mm side panels.

## berlín.60 (23.6")

Finition	Référence
Blanc mat	143 27 060
Chêne naturel	143 24 060
Pin gris	143 37 060
Wenge nature	143 44 060

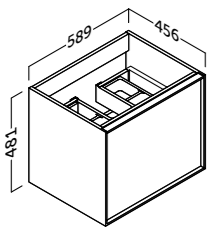

## berlín.70 (27.5")

Finition	Référence
Blanc mat	143 27 070
Chêne naturel	143 24 070
Pin gris	143 37 070
Wenge nature	143 44 070

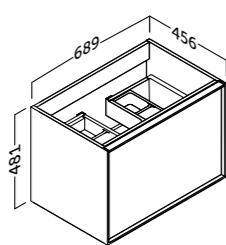

## berlín.80 (31.5")

Finition	Référence
Blanc mat	143 27 080
Chêne naturel	143 24 080
Pin gris	143 37 080
Wenge nature	143 44 080

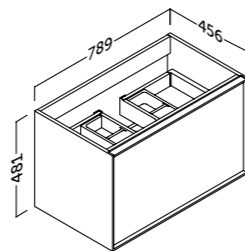

## berlín.100 (39.4")

Finition	Référence
Blanc mat	143 27 100
Chêne naturel	143 24 100
Pin gris	143 37 100
Wenge nature	143 44 100

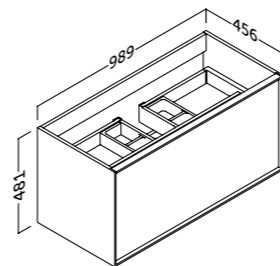

## lúxor.80 (31.5")

Finition	Référence
Blanc brillant	196 01 080
Chêne naturel	196 24 080
Pin gris	196 37 080
Noyer	196 39 080

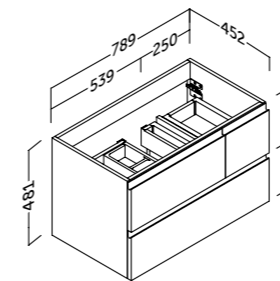

## lúxor.100 (39.4")

Finition	Référence
Blanc brillant	196 01 100
Chêne naturel	196 24 100
Pin gris	196 37 100
Noyer	196 39 100

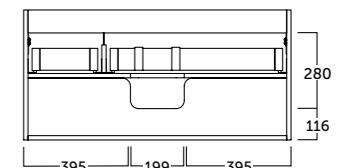
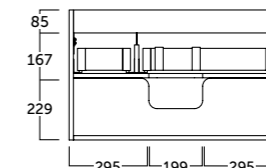
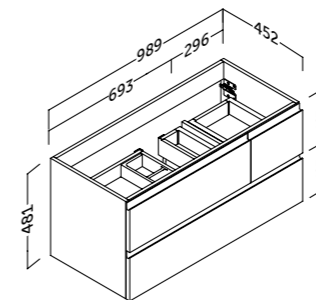

## oslo.colonne

Finition	Référence
Blanc mat	142 27 335
Chêne naturel	142 24 335
Pin gris	142 37 335
Wenge nature	142 44 335

Ouverture réversible | Reversible opening  
L'étagère en verre peut changer de position +/- 64 mm

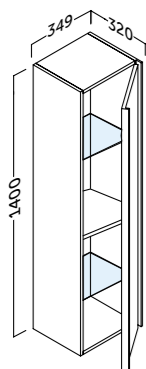

-  Fermeture ralentie. Soft close. Frenata soft close. Sanfter Verschluss. Zachtsluitend. نظام إغلاق ائوماتيكي
-  Ouverture réversible. Reversible opening. Apertura reversibile. Reversible Öffnung. Omkeerbare opening. فتح عكسيها

## cairo.colonne

Finition	Référence
Blanc brillant	194 01 335
Chêne naturel	194 24 335
Pin gris	194 37 335
Noyer	194 39 335

Ouverture réversible | Reversible opening  
L'étagère en verre peut changer de position +/- 64 mm

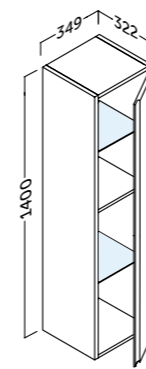

## joker.colonne haute

Finition	Référence
Blanc brillant	137 01 435
Chêne naturel	137 24 435
Pin gris	137 37 435
Noyer	137 39 435

Ouverture réversible | Reversible opening  
L'étagère en verre peut changer de position +/- 32 mm

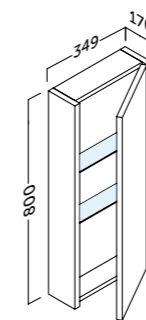

## joker.auxiliaire

Finition	Référence
Blanc brillant	137 01 445
Chêne naturel	137 24 445
Pin gris	137 37 445
Noyer	137 39 445

Ouverture réversible | Reversible opening  
L'étagère en verre peut changer de position +/- 32 mm

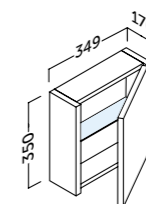

-  Fermeture ralentie. Soft close. Frenata soft close. Sanfter Verschluss. Zachtsluitend. نظام إغلاق ائوماتيكي
-  Ouverture réversible. Reversible opening. Apertura reversibile. Reversible Öffnung. Omkeerbare opening. فتح عكسيها





# toscana.



- Glissières métalliques. Metal interior drawers. Sistema di estrazione metallico. Metallizierleiste. Metalen zijkanten. درج معدني
- Organisateur. Organizer unit. Organizzatore. Obere Ablage. Superieure organizer. منظم درج علوي
- Fermeture ralentie. Soft close. Frenata soft close. Sanfter Verschluss. Zachtsluitend. نظام إغلاق اوتوماتيكي
- Extraction e. extraction. Estrazione e. Komplett herausziehbar. Volledig uittrekbaar. نظام فتح درج كامل
- Glissières Hettich. Hettich sliding system. Guide Hettich. Korpuschiene Hettich. Hettich lade system. مفصلات الجانبيه هيتش
- Laqué mate. Matte lacquered finish. Laccato opaco. Matt lackiert. Mat gelakt. لكر مت
- Mélamine structuré. Textured melamine. Melamina testurizzata. Textur mit Relief. Reliefstructuur. ملمس منقوش

- 2 tiroirs réglable avec côtés métalliques à extraction e et fermeture ralentie silencieuse.
- Façades 19 mm / Latérale 22 mm.
- 2 adjustable drawers with metal sides with extraction and silentslow closing.
- 19 mm front / 22 mm side panels.

# oslo.



- Finition texture. Texture finish. Finitura trama. Textur-Finish. Textuur afwerking. الانتهاء من الملمس
- Organisateur. Organizer unit. Organizzatore. Obere Ablage. Superieure organizer. منظم درج علوي
- Fermeture ralentie. Soft close. Frenata soft close. Sanfter Verschluss. Zachtsluitend. نظام إغلاق اوتوماتيكي
- Façades réglables. Adjustable front. Frontali regolabili. Einstellbare Vorderseite. Verstelbaar front. الدروج الامامية قابلة للتعديل
- Glissières Hettich. Hettich sliding system. Guide Hettich. Korpuschiene Hettich. Hettich lade system. مفصلات الجانبيه هيتش
- Laqué brillant. Glossy lacquered finish. Laccato lucido. Glanzend lackiert. Hoogglans gelakt. لكر مج
- Laqué mate. Matte lacquered finish. Laccato opaco. Matt lackiert. Mat gelakt. لكر مت
- Mélamine structuré. Textured melamine. Melamina testurizzata. Textur mit Relief. Reliefstructuur. ملمس منقوش

- Suspentes réglables en hauteur et en profondeur.
- 2 tiroirs façades réglables et porte avec fermeture ralentie et poignées intégrées.
- Façades MDF 16 mm. Latérale MDF 16 mm.
- Height and depth adjustable suspension.
- 2 adjustable drawers and door with silentslow closing and integrated handles.
- 16 mm MDF front / 16 mm side panels.

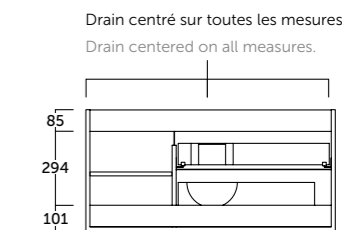

## toscana.60 (23.6")

Finition	Référence
Blanc mat	197 27 060
Deep blue mat	197 18 060
Chêne naturel	197 24 060
Pin gris	197 37 060

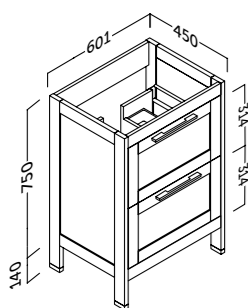

## toscana.80 (31.5")

Finition	Référence
Blanc mat	197 27 080
Deep blue mat	197 18 080
Chêne naturel	197 24 080
Pin gris	197 37 080

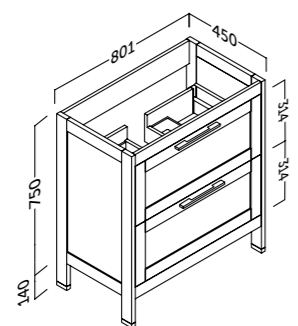

## toscana.100 (39.4")

Finition	Référence
Blanc mat	197 27 100
Deep blue mat	197 18 100
Chêne naturel	197 24 100
Pin gris	197 37 100

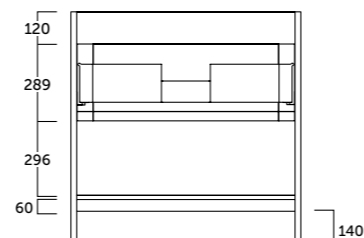
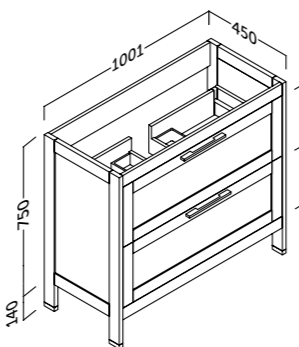

## toscana.colonne

Finition	Référence
Blanc mat	197 27 335
Deep blue mat	197 18 335
Chêne naturel	197 24 335
Pin gris	197 37 335

Ouverture réversible | Reversible opening  
L'étagère en verre peut changer de position +/- 64 mm  
The glass shelf can change the position +/- 64 mm

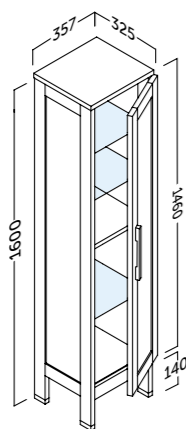

- Fermeture ralentie. Soft close. Frenata soft close. Sanfter Verschluss. Zachtsluitend. نظام إغلاق اوتوماتيكي
- Ouverture réversible. Reversible opening. Apertura reversibile. Reversible Öffnung. فتح عكسيها

## oslo.70 (27.5")

Finition	Référence
Blanc brillant	142 01 070
Blanc mat	142 27 070
Chêne naturel	142 24 070
Pin gris	142 37 070
Wenge nature	142 44 070

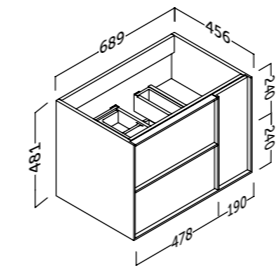

## oslo.colonne

Finition	Référence
Blanc brillant	142 01 335
Blanc mat	142 27 335
Chêne naturel	142 24 335
Pin gris	142 37 335
Wenge nature	142 44 335

Ouverture réversible | Reversible opening  
L'étagère en verre peut changer de position +/- 64 mm

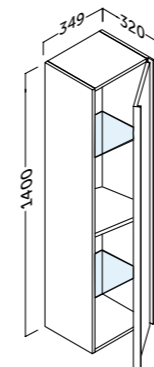

## oslo.80 (31.5")

Finition	Référence
Blanc brillant	142 01 080
Blanc mat	142 27 080
Chêne naturel	142 24 080
Pin gris	142 37 080
Wenge nature	142 44 080

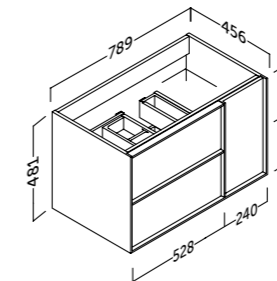

## joker.colonne haute

Finition	Référence
Blanc brillant	137 01 435
Chêne naturel	137 24 435
Pin gris	137 37 435
Wenge nature	137 44 435

Ouverture réversible | Reversible opening

L'étagère en verre peut changer de position +/- 32 mm

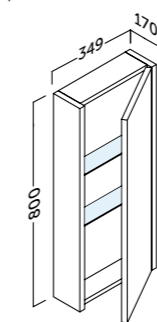

## oslo.100 (39.4")

Finition	Référence
Blanc brillant	142 01 100
Blanc mat	142 27 100
Chêne naturel	142 24 100
Pin gris	142 37 100
Wenge nature	142 44 100

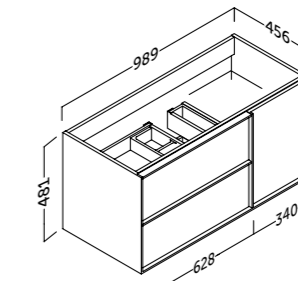

## joker.auxiliaire

Finition	Référence
Blanc brillant	137 01 445
Chêne naturel	137 24 445
Pin gris	137 37 445
Wenge nature	137 44 445

Ouverture réversible | Reversible opening

L'étagère en verre peut changer de position +/- 32 mm

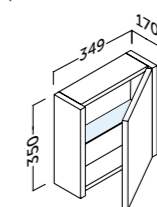

- Fermeture ralentie. Soft close. Frenata soft close. Sanfter Verschluss. Zachtsluitend. نظام إغلاق اوتوماتيكي
- Ouverture réversible. Reversible opening. Apertura reversibile. Reversible Öffnung. فتح عكسيها



Résistant à l'eau.  
Resistant to water.



# flow.

## Profondeur 46



Résistant à l'eau. Resistant to water.  
Idrorepellente. Wasserfest.  
Waterafstotend. مقاوم للماء.



Mélamine structurée. Textured melamine.  
Melamina testurizzata. Textur mit Relief.  
Reliefstruktuur. ملمس منقوش.

Système de supports invisibles et de vis inclus dans le .

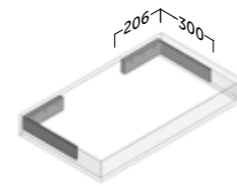

### flow.60 (23.6")

Finition	Référence
● Chêne naturel	138 24 060
● Pin gris	138 37 060

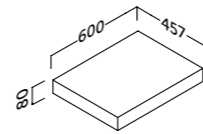

## Profondeur 40

### flow.60 (23.6")

Finition	Référence
● Chêne naturel	138 24 061
● Pin gris	138 37 061

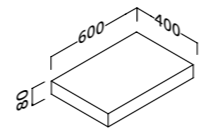

Fixation système invisible

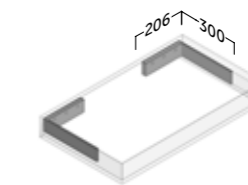

## Profondeur 46

### flow.70 (27.5")

Finition	Référence
● Chêne naturel	138 24 070
● Pin gris	138 37 070

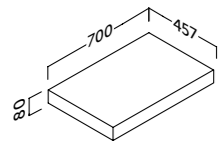

### flow.80 (31.5")

Finition	Référence
● Chêne naturel	138 24 080
● Pin gris	138 37 080

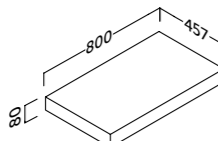

### flow.100 (39.4")

Finition	Référence
● Chêne naturel	138 24 100
● Pin gris	138 37 100

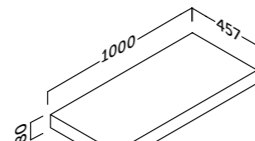

### flow.120 (47.2")

Finition	Référence
● Chêne naturel	138 24 120
● Pin gris	138 37 120

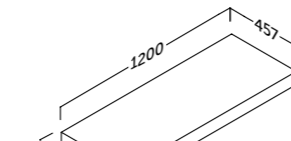

### flow.140 (55.1")

Finition	Référence
● Chêne naturel	138 24 140
● Pin gris	138 37 140

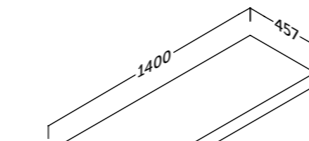

## Profondeur 40

### flow.70 (27.5")

Finition	Référence
● Chêne naturel	138 24 071
● Pin gris	138 37 071

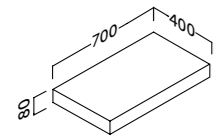

### flow.80 (31.5")

Finition	Référence
● Chêne naturel	138 24 081
● Pin gris	138 37 081

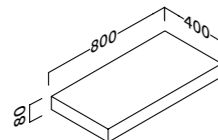

### flow.100 (39.4")

Finition	Référence
● Chêne naturel	138 24 101
● Pin gris	138 37 101

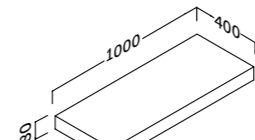

### flow.120 (47.2")

Finition	Référence
● Chêne naturel	138 24 121
● Pin gris	138 37 121

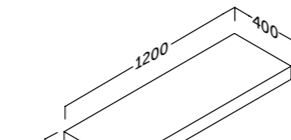

### flow.140 (55.1")

Finition	Référence
● Chêne naturel	138 24 141
● Pin gris	138 37 141

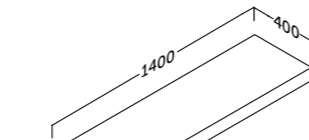

## Plan vasqué

### ambar.lip.70 (27.6")

Finition	Référence
Solid surface	524 01 070

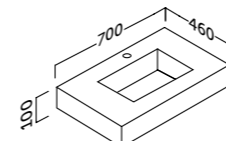

### ambar.lip.80 (31.5")

Finition	Référence
Solid surface	524 01 080

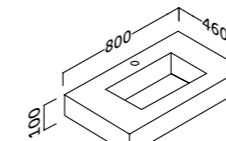

### ambar.lip.100 (39.4")

Finition	Référence
Solid surface	524 01 100

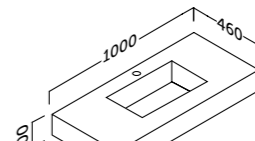

### ambar.lip.120 (47.2")

Finition	Référence
Solid surface	524 01 120

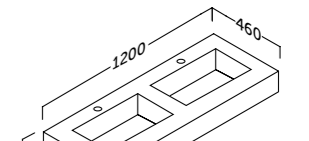

## Plateaux

### ambar.lip.70 (27.6")

Finition	Référence
Solid surface	524 01 071

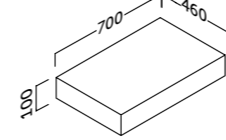

### ambar.lip.80 (31.5")

Finition	Référence
Solid surface	524 01 081

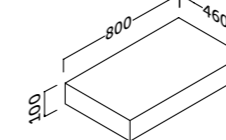

### ambar.lip.100 (39.4")

Finition	Référence
Solid surface	524 01 101

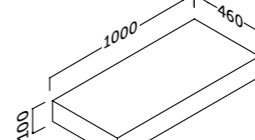

### ambar.lip.120 (47.2")

Finition	Référence
Solid surface	524 01 121

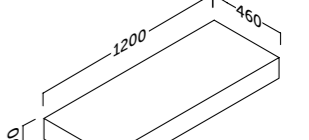

## lip porte-serviettes

Large	Référence
40 cm	416 00 003 45
60 cm	416 00 002 45

MADE IN SPAIN



## Porte-serviettes intégré

Référence
524 01 999 50

MADE IN SPAIN





# epsilon.



**Option porte-serviette / towel rail:**  
La position du porte-serviette peut être le latéral droit ou dans le coin droit.  
The towel rail can be positioned on the right-hand side or in the right-hand corner.

Résine à charge minérale avec revêtement acrylique polyuréthane.  
Made of acrylic coated mineral filler polyurethane.

Le plateau est en MDF laqué. Supports invisibles inclus.  
The shelf is made of MDF lacquered. Invisible supports are included.

MADE IN SPAIN CE

Surface traitement antibactérien  
Antibacterial treatment area

Livrées dans les 25 prochains jours ouvrables.



## plan vasque.60 (23.6")

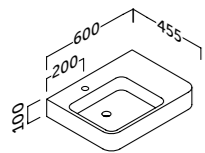

couleur	Référence*
Blanc	594 01 060
Gris ciment	594 09 060
Fango	594 18 060
Anthracite	594 03 060
Noir	594 02 060
Aubergine	594 11 060
Pourpre	594 12 060
Beige	594 05 060
Moka	594 19 060
Terre	594 20 060
Tropic	594 30 060
Turquoise	594 31 060
Ocean	594 32 060
<b>Métallisé</b>	
Mustard métallisé	594 33 060
Cooper métallisé	594 34 060
Brun métallisé	594 08 060
Noir métallisé	594 04 060
<b>Métaux</b>	
Argent métaux	594 15 060
Or métaux	594 16 060
Plomb métaux	594 17 060

## plan vasque.80 (31.5")

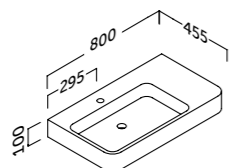

couleur	Référence*
Blanc	594 01 080
Gris ciment	594 09 080
Fango	594 18 080
Anthracite	594 03 080
Noir	594 02 080
Aubergine	594 11 080
Pourpre	594 12 080
Beige	594 05 080
Moka	594 19 080
Terre	594 20 080
Tropic	594 30 080
Turquoise	594 31 080
Ocean	594 32 080
<b>Métallisé</b>	
Mustard métallisé	594 33 080
Cooper métallisé	594 34 080
Brun métallisé	594 08 080
Noir métallisé	594 04 080
<b>Métaux</b>	
Argent métaux	594 15 080
Or métaux	594 16 080
Plomb métaux	594 17 080

## plan vasque.100 (39.4")

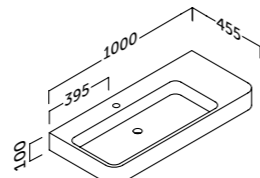

couleur	Référence*
Blanc	594 01 100
Gris ciment	594 09 100
Fango	594 18 100
Anthracite	594 03 100
Noir	594 02 100
Aubergine	594 11 100
Pourpre	594 12 100
Beige	594 05 100
Moka	594 19 100
Terre	594 20 100
Tropic	594 30 100
Turquoise	594 31 100
Ocean	594 32 100
<b>Métallisé</b>	
Mustard métallisé	594 33 100
Cooper métallisé	594 34 100
Brun métallisé	594 08 100
Noir métallisé	594 04 100
<b>Métaux</b>	
Argent métaux	594 15 100
Or métaux	594 16 100
Plomb métaux	594 17 100

## plan vasque.120 (47.2")

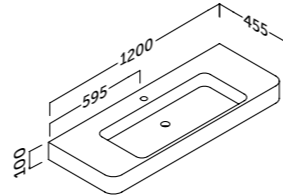

couleur	Référence*
Blanc	594 01 120
Gris ciment	594 09 120
Fango	594 18 120
Anthracite	594 03 120
Noir	594 02 120
Aubergine	594 11 120
Pourpre	594 12 120
Beige	594 05 120
Moka	594 19 120
Terre	594 20 120
Tropic	594 30 120
Turquoise	594 31 120
Ocean	594 32 120
<b>Métallisé</b>	
Mustard métallisé	594 33 120
Cooper métallisé	594 34 120
Brun métallisé	594 08 120
Noir métallisé	594 04 120
<b>Métaux</b>	
Argent métaux	594 15 120
Or métaux	594 16 120
Plomb métaux	594 17 120

## plateaux.60 (23.6")

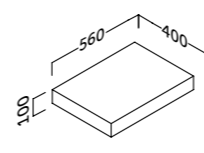

couleur	Référence
Blanc	594 01 061
Gris ciment	594 09 061
Fango	594 18 061
Anthracite	594 03 061
Noir	594 02 061
Aubergine	594 11 061
Pourpre	594 12 061
Beige	594 05 061
Moka	594 19 061
Terre	594 20 061
Tropic	594 30 061
Turquoise	594 31 061
Ocean	594 32 061
<b>Métallisé</b>	
Mustard métallisé	594 33 061
Cooper métallisé	594 34 061
Brun métallisé	594 08 061
Noir métallisé	594 04 061
<b>Métaux</b>	
Argent métaux	594 15 061
Or métaux	594 16 061
Plomb métaux	594 17 061

ecotaxe

## plateaux.80 (31.5")

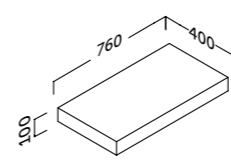

couleur	Référence
Blanc	594 01 081
Gris ciment	594 09 081
Fango	594 18 081
Anthracite	594 03 081
Noir	594 02 081
Aubergine	594 11 081
Pourpre	594 12 081
Beige	594 05 081
Moka	594 19 081
Terre	594 20 081
Tropic	594 30 081
Turquoise	594 31 081
Ocean	594 32 081
<b>Métallisé</b>	
Mustard métallisé	594 33 081
Cooper métallisé	594 34 081
Brun métallisé	594 08 081
Noir métallisé	594 04 081
<b>Métaux</b>	
Argent métaux	594 15 081
Or métaux	594 16 081
Plomb métaux	594 17 081

ecotaxe

## plateaux.100 (39.4")

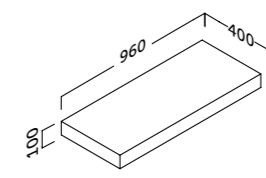

couleur	Référence
Blanc	594 01 101
Gris ciment	594 09 101
Fango	594 18 101
Anthracite	594 03 101
Noir	594 02 101
Aubergine	594 11 101
Pourpre	594 12 101
Beige	594 05 101
Moka	594 19 101
Terre	594 20 101
Tropic	594 30 101
Turquoise	594 31 101
Ocean	594 32 101
<b>Métallisé</b>	
Mustard métallisé	594 33 101
Cooper métallisé	594 34 101
Brun métallisé	594 08 101
Noir métallisé	594 04 101
<b>Métaux</b>	
Argent métaux	594 15 101
Or métaux	594 16 101
Plomb métaux	594 17 101

ecotaxe

## plateaux.120 (47.2")

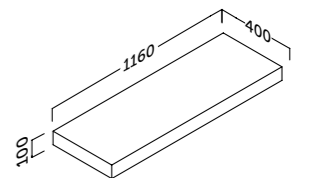

couleur	Référence
Blanc	594 01 121
Gris ciment	594 09 121
Fango	594 18 121
Anthracite	594 03 121
Noir	594 02 121
Aubergine	594 11 121
Pourpre	594 12 121
Beige	594 05 121
Moka	594 19 121
Terre	594 20 121
Tropic	594 30 121
Turquoise	594 31 121
Ocean	594 32 121
<b>Métallisé</b>	
Mustard métallisé	594 33 121
Cooper métallisé	594 34 121
Brun métallisé	594 08 121
Noir métallisé	594 04 121
<b>Métaux</b>	
Argent métaux	594 15 121
Or métaux	594 16 121
Plomb métaux	594 17 121

ecotaxe

\* Ajouter à la Référence: Porte-serviettes latérale (L), angle (E)

# praga.



- Finition texture. Texture finish. Finitura trama. Textur-Finish. Textuur afwerking. الانتهاء من الملمس
- Organisateur. Organizer unit. Organizzatore. Obere Ablage. Superiore organizer. منظم درج علوي
- Fermeture ralentie. Soft close. Frenata soft close. Sanfter Verschluss. Zachtsluitend. نظام إغلاق انوماتيكي
- Façades réglables. Adjustable front. Frontali regolabili. Einstellbare Vorderseite. Verstelbaar front. الدروج الامامية قابلة للتعديل
- Glissières Hettich. Hettich sliding system. Guide Hettich. Korpuschiene Hettich. Hettich lade system. مفصلات القاذبة هيتش
- Laquée brillante. Glossy lacquered finish. Laccato lucido. Glänzend lackiert. Hoogglans gelakt. لكر ليغ
- Mèlamine structuré. Textured melamine. Melamina testurizzata. Textur mit Relief. Reliefstructuur. ملمس منقوش

- Suspentes réglables en hauteur et en profondeur.
- 2 tiroirs façades réglables avec fermeture ralentie et poignées intégrées.
- Façades MDF 22 mm / Façades Finition blanc MDF 19 mm . Latérale MDF 16 mm.
- Height and depth adjustable suspension.
- 2 adjustable drawers and door with silents-low closing and integrated handles.
- 22 mm MDF front / 19 mm white finish. 16 mm MDF side panels.

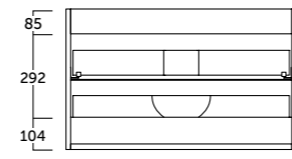

- Finition texture. Texture finish. Finitura trama. Textur-Finish. Textuur afwerking. الانتهاء من الملمس
- Organisateur. Organizer unit. Organizzatore. Obere Ablage. Superiore organizer. منظم درج علوي
- Fermeture ralentie. Soft close. Frenata soft close. Sanfter Verschluss. Zachtsluitend. نظام إغلاق انوماتيكي
- Façades réglables. Adjustable front. Frontali regolabili. Einstellbare Vorderseite. Verstelbaar front. الدروج الامامية قابلة للتعديل
- Glissières Hettich. Hettich sliding system. Guide Hettich. Korpuschiene Hettich. Hettich lade system. مفصلات القاذبة هيتش
- Mèlamine structuré. Textured melamine. Melamina testurizzata. Textur mit Relief. Reliefstructuur. ملمس منقوش

- Suspentes réglables en hauteur et en profondeur.
- 2 tiroirs façades réglables avec fermeture ralentie et poignées intégrées.
- Façades MDF 22 mm. Latérale MDF 19 mm.
- Height and depth adjustable suspension.
- 2 adjustable drawers and door with silents-low closing and integrated handles.
- 22 mm MDF front. 19 mm MDF side panels.

**praga.60** (23.6")

Finition	Référence
Blanc brillant	162 01 060
Chêne naturel	162 24 060
Pin gris	162 37 060
Wenge nature	162 44 060

**praga.70** (27.5")

Finition	Référence
Blanc brillant	162 01 070
Chêne naturel	162 24 070
Pin gris	162 37 070
Wenge nature	162 44 070

**praga.80** (31.5")

Finition	Référence
Blanc brillant	162 01 080
Chêne naturel	162 24 080
Pin gris	162 37 080
Wenge nature	162 44 080

**praga.100** (39.4")

Finition	Référence
Blanc brillant	162 01 100
Chêne naturel	162 24 100
Pin gris	162 37 100
Wenge nature	162 44 100

**praga.120** (47.2")

Finition	Référence
Blanc brillant	162 01 120
Chêne naturel	162 24 120
Pin gris	162 37 120
Wenge nature	162 44 120

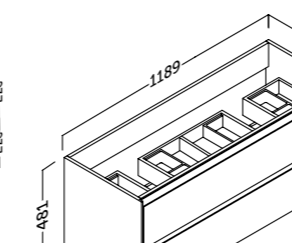
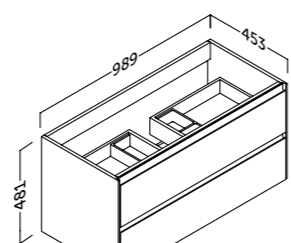
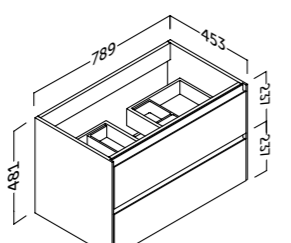
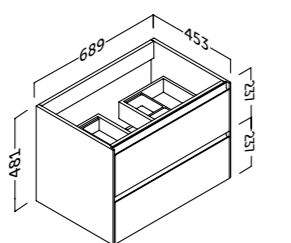
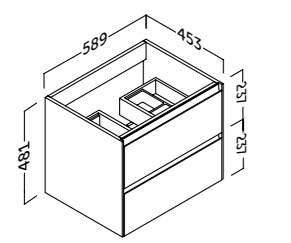

**hole.80** (31.5")

Finition	Référence
Chêne naturel	132 24 080
Pin gris	132 37 080

**hole.90** (35.4")

Finition	Référence
Chêne naturel	132 24 090
Pin gris	132 37 090

**hole.100** (39.4")

Finition	Référence
Chêne naturel	132 24 100
Pin gris	132 37 100

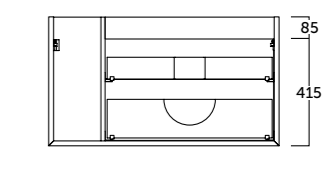
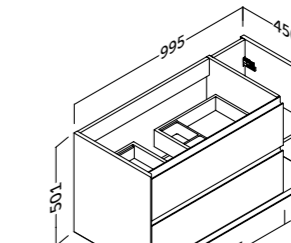
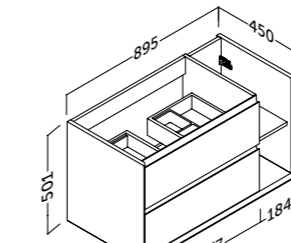
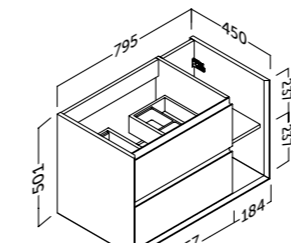

**cairo.colonne**

Finition	Référence
Blanc brillant	194 01 335
Chêne naturel	194 24 335
Pin gris	194 37 335
Wenge nature	194 44 335

**joker.colonne haute**

Finition	Référence
Blanc brillant	137 01 435
Chêne naturel	137 24 435
Pin gris	137 37 435
Wenge nature	137 44 435

**joker.auxiliaire**

Finition	Référence
Blanc brillant	137 01 445
Chêne naturel	137 24 445
Pin gris	137 37 445
Wenge nature	137 44 445

- Fermeture ralentie. Soft close. Frenata soft close. Sanfter Verschluss. Zachtsluitend. نظام إغلاق انوماتيكي
- Ouverture réversible. Reversible opening. Apertura reversibile. Reversible Öffnung. Omkeerbare opening. فتح عكسها

Ouverture réversible | Reversible opening

Ouverture réversible | Reversible opening

Ouverture réversible | Reversible opening

L'étagère en verre peut changer de position +/- 64 mm

L'étagère en verre peut changer de position +/- 32 mm

L'étagère en verre peut changer de position +/- 32 mm

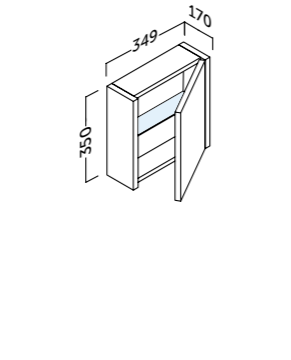
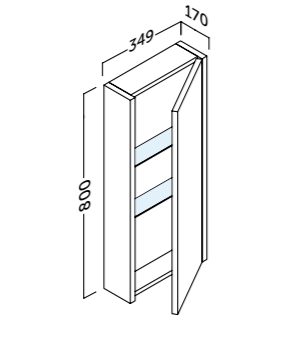
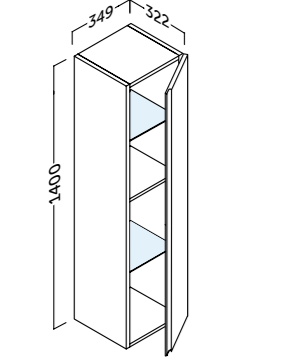

**cairo.colonne**

Finition	Référence
Chêne naturel	194 24 335
Pin gris	194 37 335

**joker.colonne haute**

Finition	Référence
Chêne naturel	137 24 435
Pin gris	137 37 435

**joker.auxiliaire**

Finition	Référence
Chêne naturel	137 24 445
Pin gris	137 37 445

Ouverture réversible | Reversible opening

Ouverture réversible | Reversible opening

Ouverture réversible | Reversible opening

L'étagère en verre peut changer de position +/- 64 mm

L'étagère en verre peut changer de position +/- 32 mm

L'étagère en verre peut changer de position +/- 32 mm

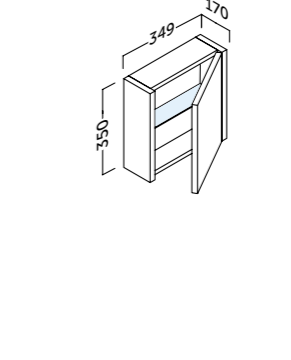
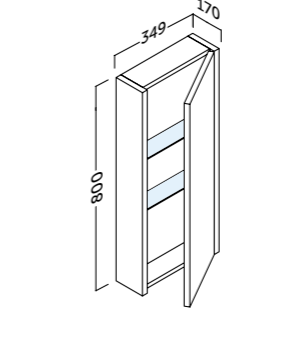
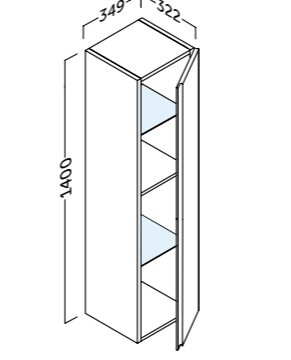

- Fermeture ralentie. Soft close. Frenata soft close. Sanfter Verschluss. Zachtsluitend. نظام إغلاق انوماتيكي
- Ouverture réversible. Reversible opening. Apertura reversibile. Reversible Öffnung. Omkeerbare opening. فتح عكسها





# galsaky.



- Finition texture. Texture finish. Finitura trama. Textur-Finish. Textuur afwerking. الانتهاء من الملمس
- Organisateur. Organizer unit. Organizzatore. Obere Ablage. Superieure organizer. منظم درج علوي
- Fermeture ralentie. Soft close. Frenata soft close. Sanfter Verschluss. Zachtsluitend. نظام إغلاق التوماتيكي
- Façades réglables. Adjustable front. Frontali regolabili. Einstellbare Vorderseite. Verstelbaar front. الدروج الامامية قابلة للتعديل
- Glissières Hettich. Hettich sliding system. Guide Hettich. Korpusschiene Hettich. Hettich lade system. مفصلات الجانبيه هيتش
- Laquéeé brillant. Glossy lacquered finish. Laccato lucido. Glanzend lackiert. Hoogglans gelakt. نكر لميخ
- Mélamine structuré. Textured melamine. Melamina testurizzata. Textur mit Relief. Reliefstructuur. ملمس منقوش

- Suspentes réglables en hauteur et en profondeur avec système anti-décrochement.
- 2 tiroirs façades réglables avec fermeture ralentie et poignées en métal.
- Façades 19 mm / Latérale 16 mm.
- Height and depth adjustable suspension with anti-detachment system.
- 2 adjustable drawers and door with silents-low closing and metal handles.
- 19 mm front / 16 mm side panels.

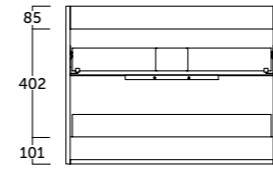

# galsaky. INDUSTRIAL

- Finition texture. Texture finish. Finitura trama. Textur-Finish. Textuur afwerking. الانتهاء من الملمس
- Organisateur. Organizer unit. Organizzatore. Obere Ablage. Superieure organizer. منظم درج علوي
- Fermeture ralentie. Soft close. Frenata soft close. Sanfter Verschluss. Zachtsluitend. نظام إغلاق التوماتيكي
- Façades réglables. Adjustable front. Frontali regolabili. Einstellbare Vorderseite. Verstelbaar front. الدروج الامامية قابلة للتعديل
- Glissières Hettich. Hettich sliding system. Guide Hettich. Korpusschiene Hettich. Hettich lade system. مفصلات الجانبيه هيتش
- Laquéeé brillant. Glossy lacquered finish. Laccato lucido. Glanzend lackiert. Hoogglans gelakt. نكر لميخ
- Mélamine structuré. Textured melamine. Melamina testurizzata. Textur mit Relief. Reliefstructuur. ملمس منقوش

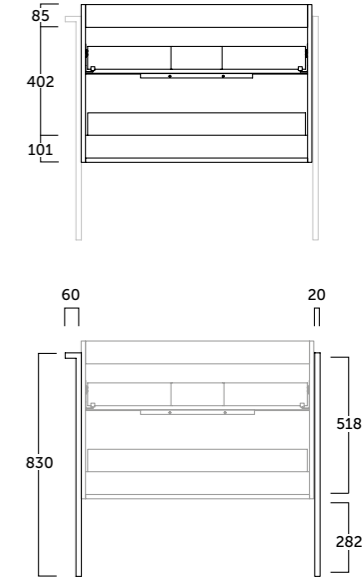

## galsaky.60 (23.6")

Finition	Référence
Blanc brillant	151 01 060
Gris brillant	151 03 060
Chêne naturel	151 24 060
Pin gris	151 37 060
Noyer	151 39 060

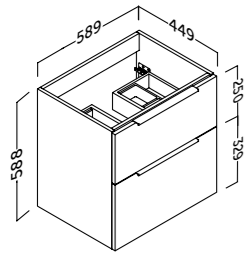

## galsaky.70 (27.5")

Finition	Référence
Blanc brillant	151 01 070
Gris brillant	151 03 070
Chêne naturel	151 24 070
Pin gris	151 37 070
Noyer	151 39 070

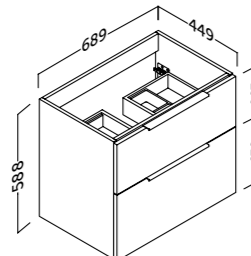

## galsaky.80 (31.5")

Finition	Référence
Blanc brillant	151 01 080
Gris brillant	151 03 080
Chêne naturel	151 24 080
Pin gris	151 37 080
Noyer	151 39 080

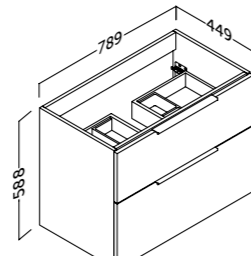

## galsaky.100 (39.4")

Finition	Référence
Blanc brillant	151 01 100
Gris brillant	151 03 100
Chêne naturel	151 24 100
Pin gris	151 37 100
Noyer	151 39 100

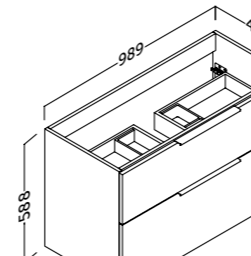

## galsaky.IND.60 (23.6")

Finition	Référence
Blanc brillant	150 01 060
Gris brillant	150 03 060
Chêne naturel	150 24 060
Pin gris	150 37 060
Noyer	150 39 060

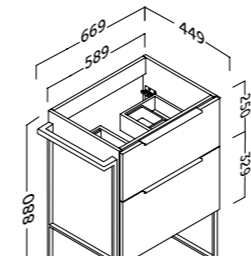

## galsaky.IND.70 (27.5")

Finition	Référence
Blanc brillant	150 01 070
Gris brillant	150 03 070
Chêne naturel	150 24 070
Pin gris	150 37 070
Noyer	150 39 070

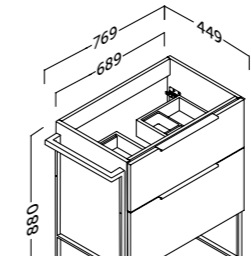

## galsaky.IND.80 (31.5")

Finition	Référence
Blanc brillant	150 01 080
Gris brillant	150 03 080
Chêne naturel	150 24 080
Pin gris	150 37 080
Noyer	150 39 080

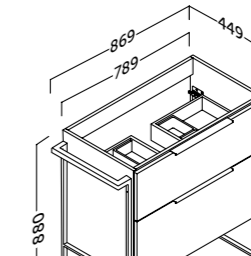

## galsaky.IND.100 (39.4")

Finition	Référence
Blanc brillant	150 01 100
Gris brillant	150 03 100
Chêne naturel	150 24 100
Pin gris	150 37 100
Noyer	150 39 100

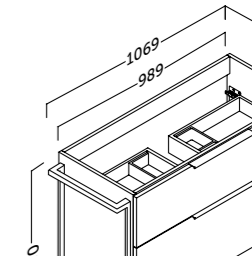

## joker.colonne

Finition	Référence
Blanc brillant	137 01 335
Gris brillant	137 03 335
Chêne naturel	137 24 335
Pin gris	137 37 335
Noyer	137 39 335

Ouverture réversible | Reversible opening

L'étagère en verre peut changer de position +/- 64 mm

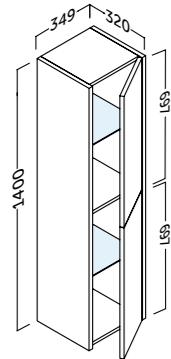

## joker.colonne haute

Finition	Référence
Blanc brillant	137 01 435
Gris brillant	137 03 435
Chêne naturel	137 24 435
Pin gris	137 37 435
Noyer	137 39 435

Ouverture réversible | Reversible opening

L'étagère en verre peut changer de position +/- 32 mm

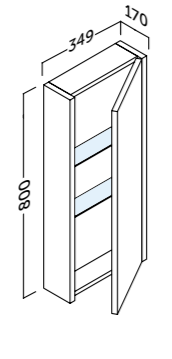

## joker.auxiliaire

Finition	Référence
Blanc brillant	137 01 445
Gris brillant	137 03 445
Chêne naturel	137 24 445
Pin gris	137 37 445
Noyer	137 39 445

Ouverture réversible | Reversible opening

L'étagère en verre peut changer de position +/- 32 mm

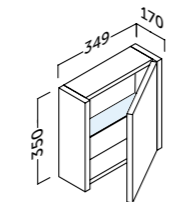

## poignées noires.

Finition	Référence
Noir	412 02 730



- Fermeture ralentie. Soft close. Frenata soft close. Sanfter Verschluss. Zachtsluitend. نظام إغلاق التوماتيكي

- Ouverture réversible. Reversible opening. Apertura reversibile. Reversible Öffnung. فتح عكسيها

MADE IN SPAIN



## galsaky.IND.120 (47.2")

Finition	Référence
Blanc brillant	150 01 120
Gris brillant	150 03 120
Chêne naturel	150 24 120
Pin gris	150 37 120
Noyer	150 39 120

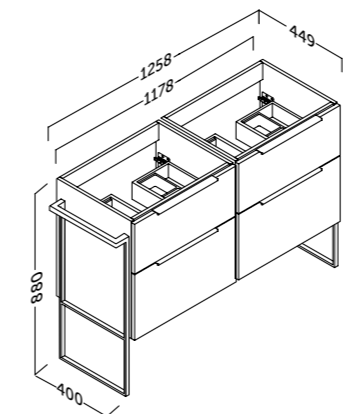

## étagère.IND

Finition	Référence
Blanc brillant	412 01 700
Gris brillant	412 03 700
Chêne naturel	412 24 700
Pin gris	412 37 700
Noyer	412 39 700

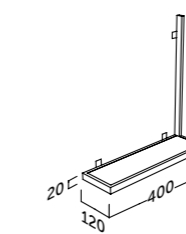

Compatible avec toutes les mesures de miroirs SUN. Emplacement du côté droit seulement.

MADE IN SPAIN



# escorpio.



- Finition texture. Texture finish. Finitura trama. Textur-Finish. Textuur afwerking. الانتهاء من الملمس
- Organisateur. Organizer unit. Organizzatore. Obere Ablage. Superiore organizer. منظم درج علوي
- Fermeture ralentie. Soft close. Frenata soft close. Sanfter Verschluss. Zachtsluitend. نظام إغلاق أومياتيكي
- Façades réglables. Adjustable front. Frontali regolabili. Einstellbare Vorderseite. Verstelbaar front. الدروج الامامية قابلة للتعديل
- Glissières Hettich. Hettich sliding system. Guide Hettich. Korpuschiene Hettich. Hettich lade system. مفصلات الجانبيه هتيتش
- Laquée brillant. Glossy lacquered finish. Laccato lucido. Glänzend lackiert. Hoogglans gelakt. لكر ليح
- Mélamine structuré. Textured melamine. Melamina testurizzata. Textur mit Relief. Reliefstructuur. ملمس منقوش

- 3 tiroirs façades réglables avec fermeture ralentie et poignées en métal.
- Pieds réglables en hauteur.
- Façades 19 mm / Latérale 19 mm.
- 3 adjustable drawers with silentslow closing and metal handles.
- Height adjustable legs.
- 19 mm front / 19 mm side panels.

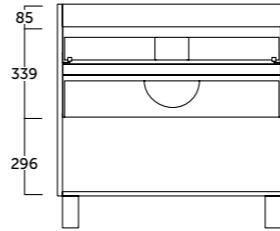

- Finition texture. Texture finish. Finitura trama. Textur-Finish. Textuur afwerking. الانتهاء من الملمس
- Organisateur. Organizer unit. Organizzatore. Obere Ablage. Superiore organizer. منظم درج علوي
- Fermeture ralentie. Soft close. Frenata soft close. Sanfter Verschluss. Zachtsluitend. نظام إغلاق أومياتيكي
- Façades réglables. Adjustable front. Frontali regolabili. Einstellbare Vorderseite. Verstelbaar front. الدروج الامامية قابلة للتعديل
- Glissières Hettich. Hettich sliding system. Guide Hettich. Korpuschiene Hettich. Hettich lade system. مفصلات الجانبيه هتيتش
- Fermeture ralentie. Soft close. Frenata soft close. Sanfter Verschluss. Zachtsluitend. نظام إغلاق أومياتيكي
- Laquée brillant. Glossy lacquered finish. Laccato lucido. Glänzend lackiert. Hoogglans gelakt. لكر ليح
- Mélamine structuré. Textured melamine. Melamina testurizzata. Textur mit Relief. Reliefstructuur. ملمس منقوش

- 3 tiroirs façades réglables et porte avec fermeture ralentie et poignées intégrées.
- Pieds réglables en hauteur.
- Façades MDF 22 mm / Façades Finition blanc MDF 19 mm. Latérale 19 mm.
- 3 adjustable drawers and door with silentslow closing and integrated handles.
- Height adjustable legs.
- 22 mm MDF front / 19 mm MDF white finish. 19 mm side panels.

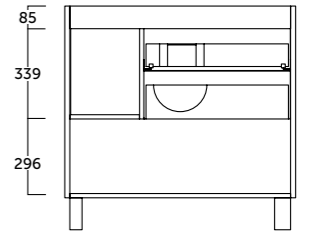

## escorpio.60 (23.6")

Finition	Référence
Blanc brillant	123 01 060
Chêne naturel	123 24 060
Pin gris	123 37 060
Wenge nature	123 44 060

## escorpio.70 (27.5")

Finition	Référence
Blanc brillant	123 01 070
Chêne naturel	123 24 070
Pin gris	123 37 070
Wenge nature	123 44 070

## escorpio.80 (31.5")

Finition	Référence
Blanc brillant	123 01 080
Chêne naturel	123 24 080
Pin gris	123 37 080
Wenge nature	123 44 080

## escorpio.100 (39.4")

Finition	Référence
Blanc brillant	123 01 100
Chêne naturel	123 24 100
Pin gris	123 37 100
Wenge nature	123 44 100

## cervino.70 (27.5")

Finition	Référence
Blanc brillant	141 01 070
Chêne naturel	141 24 070
Pin gris	141 37 070
Wenge nature	141 44 070

## cervino.80 (31.5")

Finition	Référence
Blanc brillant	141 01 080
Chêne naturel	141 24 080
Pin gris	141 37 080
Wenge nature	141 44 080

## cervino.90 (35.4")

Finition	Référence
Blanc brillant	141 01 090
Chêne naturel	141 24 090
Pin gris	141 37 090
Wenge nature	141 44 090

## cervino.100 (39.4")

Finition	Référence
Blanc brillant	141 01 100
Chêne naturel	141 24 100
Pin gris	141 37 100
Wenge nature	141 44 100

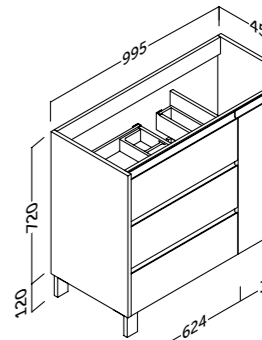
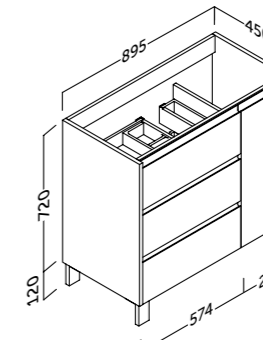
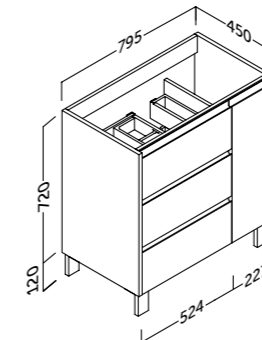
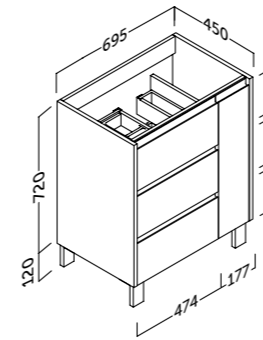
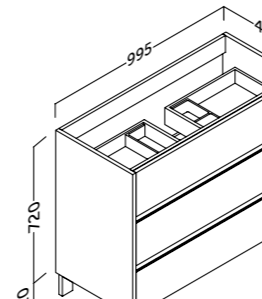
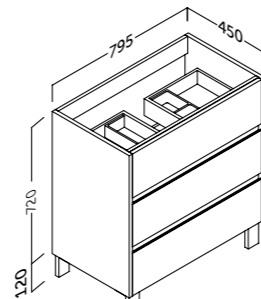
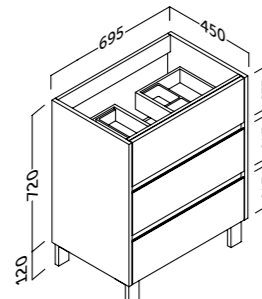
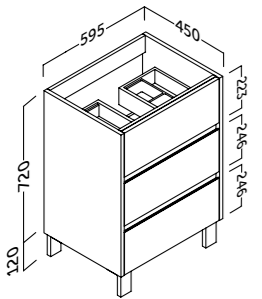

## joker.colonne

Finition	Référence
Blanc brillant	137 01 335
Chêne naturel	137 24 335
Pin gris	137 37 335
Wenge nature	137 44 335

Ouverture réversible | Reversible opening  
L'étagère en verre peut changer de position +/- 64 mm

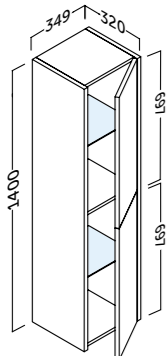

## joker.colonne haute

Finition	Référence
Blanc brillant	137 01 435
Chêne naturel	137 24 435
Pin gris	137 37 435
Wenge nature	137 44 435

Ouverture réversible | Reversible opening  
L'étagère en verre peut changer de position +/- 32 mm

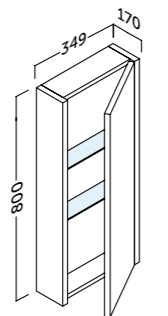

## joker.auxiliaire

Finition	Référence
Blanc brillant	137 01 445
Chêne naturel	137 24 445
Pin gris	137 37 445
Wenge nature	137 44 445

Ouverture réversible | Reversible opening  
L'étagère en verre peut changer de position +/- 32 mm

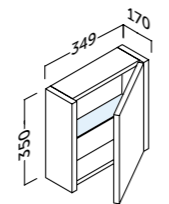

- Fermeture ralentie. Soft close. Frenata soft close. Sanfter Verschluss. Zachtsluitend. نظام إغلاق أومياتيكي

- Ouverture réversible. Reversible opening. Apertura reversibile. Reversible Öffnung. Omkeerbare opening. فتح عكسها

## cairo.colonne

Finition	Référence
Blanc brillant	194 01 335
Chêne naturel	194 24 335
Pin gris	194 37 335
Wenge nature	194 44 335

Ouverture réversible | Reversible opening  
L'étagère en verre peut changer de position +/- 64 mm

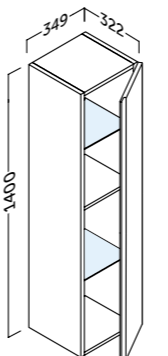

## joker.colonne haute

Finition	Référence
Blanc brillant	137 01 435
Chêne naturel	137 24 435
Pin gris	137 37 435
Wenge nature	137 44 435

Ouverture réversible | Reversible opening  
L'étagère en verre peut changer de position +/- 32 mm

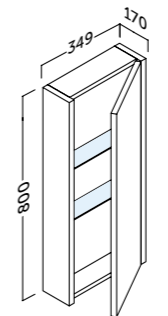

## joker.auxiliaire

Finition	Référence
Blanc brillant	137 01 445
Chêne naturel	137 24 445
Pin gris	137 37 445
Wenge nature	137 44 445

Ouverture réversible | Reversible opening  
L'étagère en verre peut changer de position +/- 32 mm

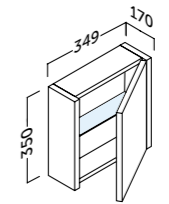

- Fermeture ralentie. Soft close. Frenata soft close. Sanfter Verschluss. Zachtsluitend. نظام إغلاق أومياتيكي

- Ouverture réversible. Reversible opening. Apertura reversibile. Reversible Öffnung. Omkeerbare opening. فتح عكسها

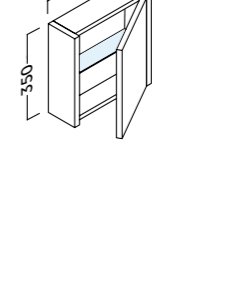
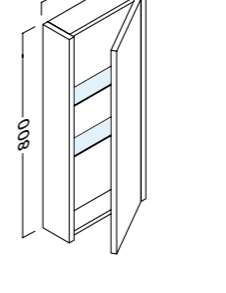
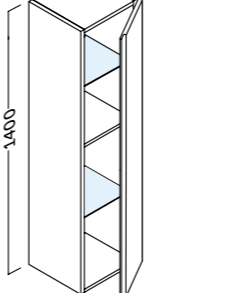





## comet. profondeur réduite

- Finition texture. Texture finish. Finitura trama. Textur-Finish. Textuur afwerking. الانتهاء من الملمس
- Organisateur. Organizer unit. Organizzatore. Obere Ablage. Superieure organizer. منظم درج علوي
- Fermeture ralentie. Soft close. Frenata soft close. Sanfter Verschluss. Zachtsluitend. نظام إغلاق أوماتيكي
- Façades réglables. Adjustable front. Frontali regolabili. Einstellbare Vorderseite. Verstelbaar front. الدروج الامامية قابلة للتعديل
- Glissières Hettich. Hettich sliding system. Guide Hettich. Korpusschiene Hettich. Hettich lade system. مفصلات الجانبيههتيش
- Laquéé brillant. Glossy lacquered finish. Laccato lucido. Glanzend lackiert. Hoogglans gelakt. لكر لمج
- Mélangé structuré. Textured melamine. Melamina testurizzata. Textur mit Relief. Reliefstructuur. ملمس منقوش

- Suspentes réglables en hauteur et en profondeur avec système anti-décrochement.
- 2 tiroirs façades réglables avec fermeture ralentie et poignées en métal.
- Façades 19 mm / Latérale 16 mm.
- Height and depth adjustable suspension with anti-detachment system.
- 2 adjustable drawers with silent/slow closing and metal handles.
- 19 mm front / 16 mm side panels.

### poignées noires.

Finition	Référence
Noir	412 02 730



### comet.60 (23.6")

Finition	Référence
Blanc brillant	152 01 060
Chêne naturel	152 24 060

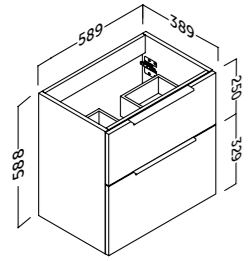

### comet.70 (27.5")

Finition	Référence
Blanc brillant	152 01 070
Chêne naturel	152 24 070

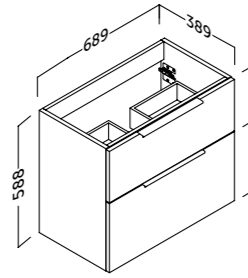

### comet.80 (31.5")

Finition	Référence
Blanc brillant	152 01 080
Chêne naturel	152 24 080

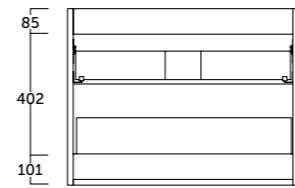
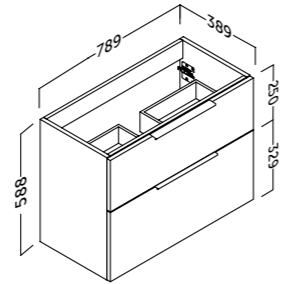

## berna. profondeur réduite

- Finition texture. Texture finish. Finitura trama. Textur-Finish. Textuur afwerking. الانتهاء من الملمس
- Organisateur. Organizer unit. Organizzatore. Obere Ablage. Superieure organizer. منظم درج علوي
- Fermeture ralentie. Soft close. Frenata soft close. Sanfter Verschluss. Zachtsluitend. نظام إغلاق أوماتيكي
- Façades réglables. Adjustable front. Frontali regolabili. Einstellbare Vorderseite. Verstelbaar front. الدروج الامامية قابلة للتعديل
- Glissières Hettich. Hettich sliding system. Guide Hettich. Korpusschiene Hettich. Hettich lade system. مفصلات الجانبيههتيش
- Laquéé brillant. Glossy lacquered finish. Laccato lucido. Glanzend lackiert. Hoogglans gelakt. لكر لمج
- Mélangé structuré. Textured melamine. Melamina testurizzata. Textur mit Relief. Reliefstructuur. ملمس منقوش

- 2 tiroirs façades réglables avec fermeture ralentie et poignées en métal.
- Façades 19 mm / Latérale 19 mm.
- 2 adjustable drawers with silent/slow closing and metal handles.
- 19 mm front / 19 mm side panels.

### berna.50 (19.7")

Finition	Référence
Blanc brillant	140 01 050
Chêne naturel	140 24 050

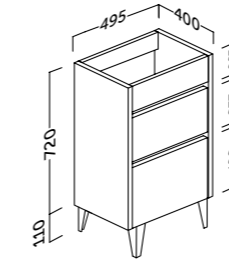

### berna.60 (23.6")

Finition	Référence
Blanc brillant	140 01 060
Chêne naturel	140 24 060

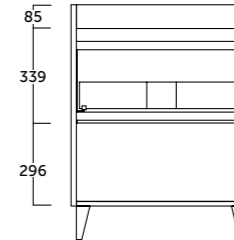
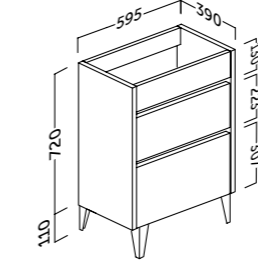

### joker.colonne

Finition	Référence
Blanc brillant	137 01 335
Chêne naturel	137 24 335

Ouverture réversible | Reversible opening  
L'étagère en verre peut changer de position +/- 64 mm

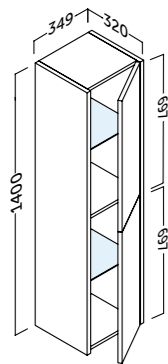

### joker.colonne haute

Finition	Référence
Blanc brillant	137 01 435
Chêne naturel	137 24 435

Ouverture réversible | Reversible opening  
L'étagère en verre peut changer de position +/- 32 mm

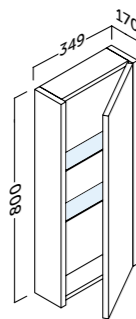

### joker.auxiliaire

Finition	Référence
Blanc brillant	137 01 445
Chêne naturel	137 24 445

Ouverture réversible | Reversible opening  
L'étagère en verre peut changer de position +/- 32 mm

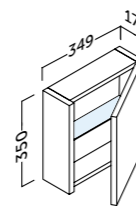

- Fermeture ralentie. Soft close. Frenata soft close. Sanfter Verschluss. Zachtsluitend. نظام إغلاق أوماتيكي
- Ouverture réversible. Reversible opening. Apertura reversibile. Reversible Öffnung. فتح عكسها.

### joker.colonne

Finition	Référence
Blanc brillant	137 01 335
Chêne naturel	137 24 335

Ouverture réversible | Reversible opening  
L'étagère en verre peut changer de position +/- 64 mm

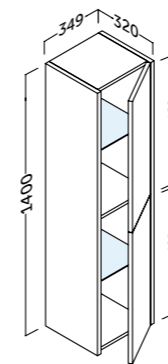

### joker.colonne haute

Finition	Référence
Blanc brillant	137 01 435
Chêne naturel	137 24 435

Ouverture réversible | Reversible opening  
L'étagère en verre peut changer de position +/- 32 mm

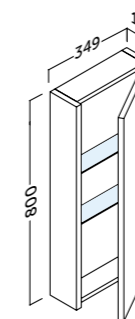

### joker.auxiliaire

Finition	Référence
Blanc brillant	137 01 445
Chêne naturel	137 24 445

Ouverture réversible | Reversible opening  
L'étagère en verre peut changer de position +/- 32 mm

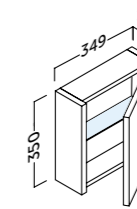

- Fermeture ralentie. Soft close. Frenata soft close. Sanfter Verschluss. Zachtsluitend. نظام إغلاق أوماتيكي
- Ouverture réversible. Reversible opening. Apertura reversibile. Reversible Öffnung. فتح عكسها.



# siena.

## profondeur réduite



- Finition texture. Texture finish. Finitura trama. Textur-Finish. Textuur afwerking. الانتهاء من الملمس
- Organisateur. Organizer unit. Organizzatore. Obere Ablage. Superior organizer. منظم درج علوي
- Fermeture ralentie. Soft close. Frenata soft close. Sanfter Verschluss. Zachtsluitend. نظام إغلاق أوتوماتيكي
- Façades réglables. Adjustable front. Frontali regolabili. Einstellbare Vorderseite. Verstelbaar front. الدروج الامامية قابلة للتعديل
- Glissières Hettich. Hettich sliding system. Guide Hettich. Korpusschiene Hettich. Hettich lade system. مفصلات الجانبيه هيتش
- Laquée brillant. Glossy lacquered finish. Laccato lucido. Glanzend lackiert. Hoogglans gelakt. تکر لمع
- Mélamine structuré. Textured melamine. Melamina testurizzata. Textur mit Relief. Reliefstructuur. ملمس منقوش

- 3 tiroirs façades réglables avec fermeture ralentie et poignées en métal.
- Façades 19 mm / Latérale 19 mm.
- 3 adjustable drawers and door with silentslow closing and metal handles.
- 19 mm front / 19 mm side panels.

**siena.70** (27.5")

Finition	Référence
○ Blanc brillant	144 01 070
● Chêne naturel	144 24 070

**siena.80** (31.5")

Finition	Référence
○ Blanc brillant	144 01 080
● Chêne naturel	144 24 080

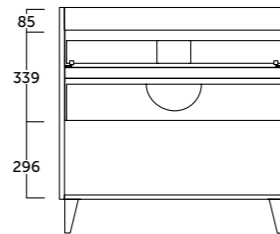
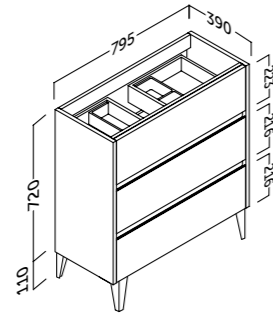
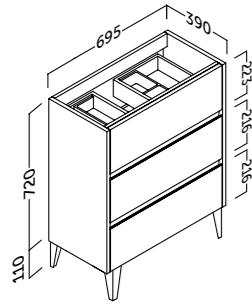

**joker.colonne**

Finition	Référence
○ Blanc brillant	137 01 335
● Chêne naturel	137 24 335

Ouverture réversible | Reversible opening  
L'étagère en verre peut changer de position +/- 64 mm

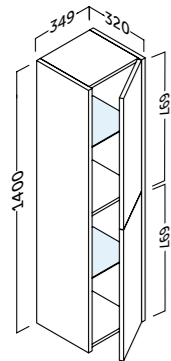

**joker.colonne haute**

Finition	Référence
○ Blanc brillant	137 01 435
● Chêne naturel	137 24 435

Ouverture réversible | Reversible opening  
L'étagère en verre peut changer de position +/- 32 mm

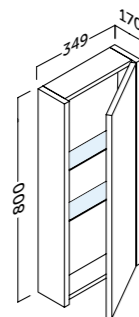

**joker.auxiliaire**

Finition	Référence
○ Blanc brillant	137 01 445
● Chêne naturel	137 24 445

Ouverture réversible | Reversible opening  
L'étagère en verre peut changer de position +/- 32 mm

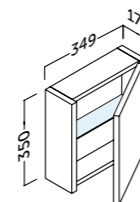

- Fermeture ralentie. Soft close. Frenata soft close. Sanfter Verschluss. Zachtsluitend. نظام إغلاق أوتوماتيكي
- Ouverture réversible. Reversible opening. Apertura reversibile. Reversible Öffnung. Omkeerbare opening. فتح عكسها



MADE IN SPAIN

# versa.

## profondeur réduite



- Finition texture. Texture finish. Finitura trama. Textur-Finish. Textuur afwerking. الانتهاء من الملمس
- Fermeture ralentie. Soft close. Frenata soft close. Sanfter Verschluss. Zachtsluitend. نظام إغلاق أوتوماتيكي
- Façades réglables. Adjustable front. Frontali regolabili. Einstellbare Vorderseite. Verstelbaar front. الدروج الامامية قابلة للتعديل
- Glissières Hettich. Hettich sliding system. Guide Hettich. Korpusschiene Hettich. Hettich lade system. مفصلات الجانبيه هيتش
- Fermeture ralentie. Soft close. Frenata soft close. Sanfter Verschluss. Zachtsluitend. نظام إغلاق أوتوماتيكي
- Laquée brillant. Glossy lacquered finish. Laccato lucido. Glanzend lackiert. Hoogglans gelakt. تکر لمع
- Mélamine structuré. Textured melamine. Melamina testurizzata. Textur mit Relief. Reliefstructuur. ملمس منقوش

- Versa 45**
- 1 porte réglables avec fermeture ralentie et poignées en métal.
  - Façades 19 mm / Latérale 16 mm.
  - 1 adjustable door with silentslow closing and metal handles.
  - 19 mm front / 16 mm side.
- Versa 55**
- 2 portes réglables et 1 tiroir avec fermeture ralentie et poignées en métal.
  - Façades 19 mm / Latérale 16 mm.
  - 2 adjustable doors and drawer with silentslow closing and metal handles.
  - 19 mm front / 16 mm side panels.

**versa.45** (17.7")

Finition	Référence
○ Blanc brillant	145 01 045
● Chêne naturel	145 24 045

**versa.55** (21.6")

Finition	Référence
○ Blanc brillant	145 01 055
● Chêne naturel	145 24 055

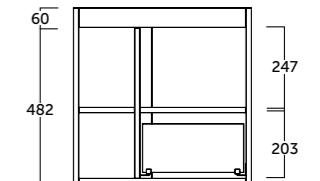
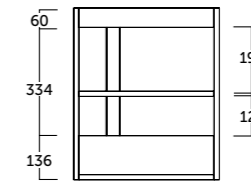
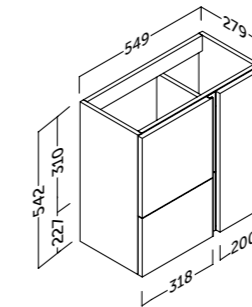
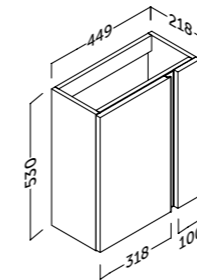

**flash.45** (17.7")

Dimension	Référence
Aluminium	45 (1 porte) 340 11 045

Ouverture réversible | Reversible opening

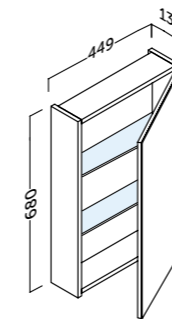

**flash.55** (21.6")

Dimension	Référence
Aluminium	55 (1 porte) 340 11 055

Ouverture réversible | Reversible opening

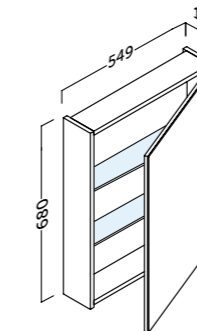

MADE IN SPAIN





# auxiliaires.



**landes.colonne**

Finition		Référence	
○ Blanc mat	112 35 336	112 35 337	
● Chêne naturel	112 24 336	112 24 337	
● Pin gris	112 37 336	112 37 337	
● Anthracite	112 45 336	112 45 337	



**landes.colonne haute**

Finition		Référence	
○ Blanc mat	112 35 435		
● Chêne naturel	112 24 435		
● Pin gris	112 37 435		
● Anthracite	112 45 435		

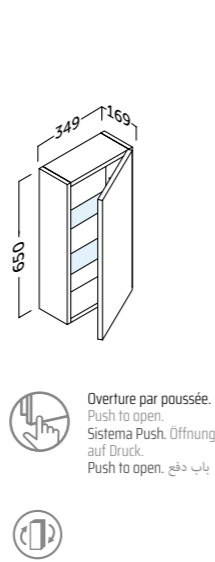

**omega.colonne**

Finition brillante		Référence	
○ Blanc brillant	193 01 335		
● Gris brillant	193 03 335		
● Beige gris brillant	193 16 335		

  

Finition mat		Référence	
○ Blanc mat	193 27 335		
● Gris intense mat	193 34 335		
● Beige gris mat	193 46 335		

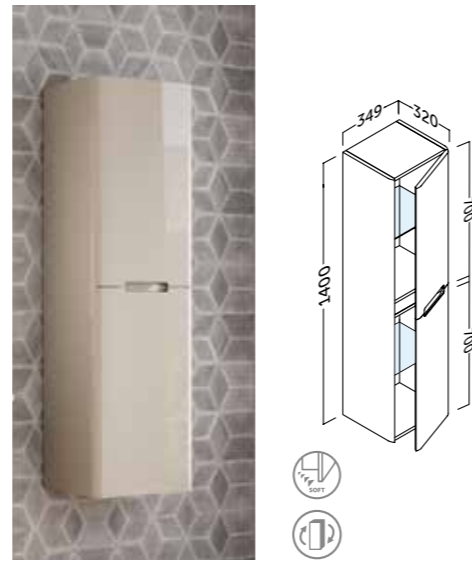

**joker.colonne**

Finition		Référence	
○ Blanc brillant	137 01 335		
● Gris brillant	137 03 335		
● Chêne naturel	137 24 335		
● Pin gris	137 37 335		
● Noyer	137 39 335		
● Wenge nature	137 44 335		

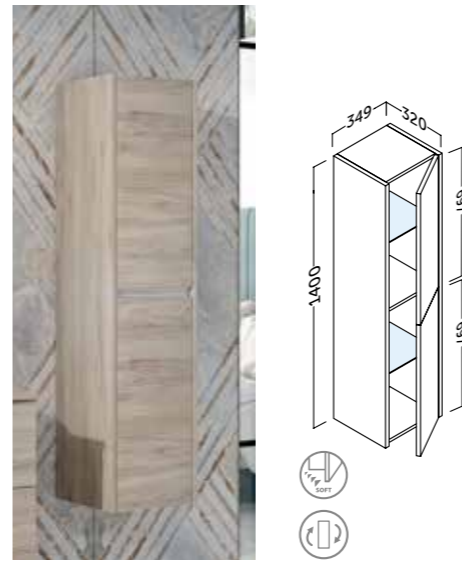

**joker.colonne haute**

Finition		Référence	
○ Blanc brillant	137 01 435		
● Gris brillant	137 03 435		
● Chêne naturel	137 24 435		
● Pin gris	137 37 435		
● Noyer	137 39 435		
● Wenge nature	137 44 435		

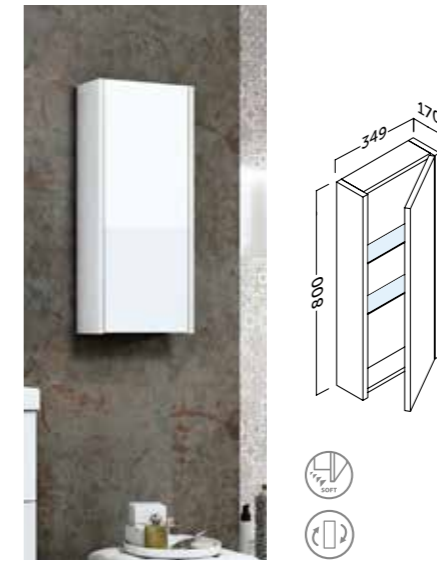

**joker.auxiliaire**

Finition		Référence	
○ Blanc brillant	137 01 445		
● Gris brillant	137 03 445		
● Chêne naturel	137 24 445		
● Pin gris	137 37 445		
● Noyer	137 39 445		
● Wenge nature	137 44 445		

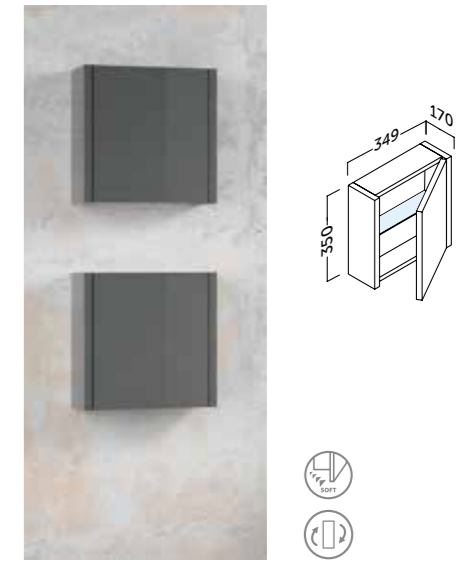

326 L'étagère en verre peut changer de position +/- 64 mm  
The glass shelf can change the position +/- 64 mm

L'étagère en verre peut changer de position +/- 32 mm  
The glass shelf can change the position +/- 32 mm

L'étagère en verre peut changer de position +/- 64 mm  
The glass shelf can change the position +/- 64 mm

L'étagère en verre peut changer de position +/- 64 mm  
The glass shelf can change the position +/- 64 mm

L'étagère en verre peut changer de position +/- 32 mm  
The glass shelf can change the position +/- 32 mm

L'étagère en verre peut changer de position +/- 32 mm  
The glass shelf can change the position +/- 32 mm

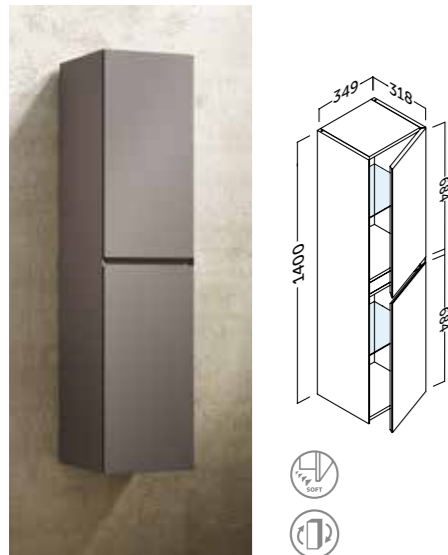

**sigma.colonne**

Finition		Référence	
○ Blanc mat	190 01 340		
● Gris intense mat	190 34 340		
● Chêne naturel	190 24 340		

L'étagère en verre peut changer de position +/- 64 mm  
The glass shelf can change the position +/- 64 mm



**sigma.colonne haute**

Finition		Référence	
○ Blanc mat	190 01 435		
● Gris intense mat	190 34 435		
● Chêne naturel	190 24 435		

L'étagère en verre peut changer de position +/- 32 mm  
The glass shelf can change the position +/- 32 mm



**oslo.colonne**

Finition		Référence	
○ Blanc brillant	142 01 335		
○ Blanc mat	142 27 335		
● Chêne naturel	142 24 335		
● Pin gris	142 37 335		
● Wenge nature	142 44 335		

L'étagère en verre peut changer de position +/- 64 mm  
The glass shelf can change the position +/- 64 mm

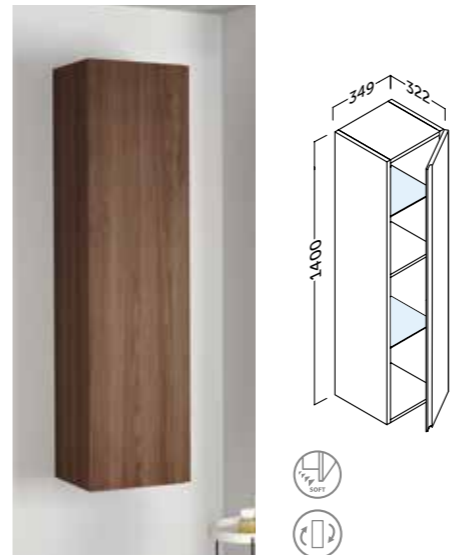

**cairo.colonne**

Finition		Référence	
○ Blanc brillant	194 01 335		
● Chêne naturel	194 24 335		
● Pin gris	194 37 335		
● Noyer	194 39 335		
● Wenge nature	194 44 335		

L'étagère en verre peut changer de position +/- 64 mm  
The glass shelf can change the position +/- 64 mm

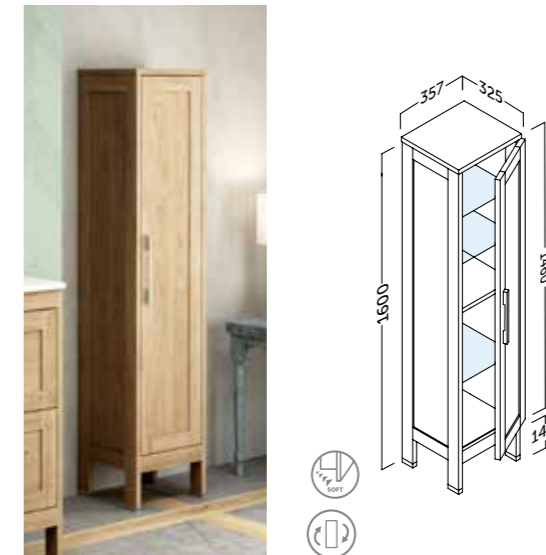

**toscana.colonne**

Finition		Référence	
○ Blanc mat	197 27 335		
● Deep blue mat	197 18 335		
● Chêne naturel	197 24 335		
● Pin gris	197 37 335		

L'étagère en verre peut changer de position +/- 64 mm  
The glass shelf can change the position +/- 64 mm

- Fermeture ralentie. Soft close. Frenata soft close. Sanfter Verschluss. Zachtsluitend. نظام إغلاق التوماتيكي.
- Colonne réversible droite-gauche en retournant la colonne. Reversible rotating column.
- Porte réversible droite-gauche en retournant la porte. Reversible rotating door.
- Étagère en verre. Glass shelf. Glasablage. Reversible Öffnung. glazen plank. الجرف الزجاجي.

MADE IN SPAIN



# spécifications technique



## Tiroirs guide

Dans la recherche constante, pour offrir la qualité maximale en nos produits, nous avons incorporé le système de guides HETTICH. Première marque mondiale et synonyme de qualité et d'innovation. Toutes les glissières sont:

- Invisibles
- A fermeture ralentie
- Silencieuses

In our constant effort to offer top quality products, we have incorporated the HETTICH runner system. World leading brand and synonymous with quality and innovation. All our drawer slides are:

- Invisible.
- Equipped with a soft-closing system.
- Noiseless.



## Tiroirs structure

Nouveau design intérieur des tiroirs. Plus pratique grâce à son organisateur inclus. En outre, la nouvelle conception confère une robustesse à cet ensemble enviable.

New interior design of the drawers. More practical thanks to its organizer included. In addition, the new design provides robustness to the enviable ensemble.



## Suspentes



Suspentes réglables en hauteur et en profondeur avec système anti-décrochement. Charge maximale 120Kg/unité. Height and depth adjustable suspension with anti-detachment system. Maximum load 120Kg/unit.



Suspentes réglables en hauteur et en profondeur. Charge maximale 45Kg/unité. Height and depth adjustable hangers. Maximum load 45Kg/unit.

### Auxiliaires / Auxiliary units



Les colonnes suspendues sont équipées de suspentes réglables. Charge maximale 50Kg/unité. The hanging units are equipped with adjustable hangers. Maximum load 50Kg/unit.



Les colonnes suspendues sont équipées de Cintres cachés. Charge maximale 65 kg/unité. Suspended columns are equipped with hidden hangers. Maximum load 65 kg/unit.

## Charnières



Toutes les charnières sont : D'une fermeture amortie Silencieuses Réglables

All doors: Are Equipped with a soft-closing system -are noiseless -are adjustable

## Vide sanitaire

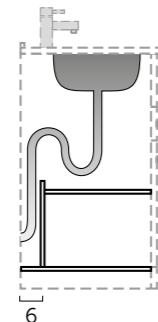

Tous nos meubles sont prévus avec un vide sanitaire standard. Valable pour tous les modèles. All our bathroom furniture has a standard sanitary cavity.

## Pieds

Les pieds de meuble sont robustes. Furniture legs are strong.



Bois fabriqué pour offrir une grande résistance à l'eau mais ne prévient pas complètement la pénétration de l'eau envers une exposition prolongée. Une partie de la structure du meuble peut ne pas avoir ces propriétés.



Wood designed to offers greater resistance to water but no entirely prevent the penetration of water into a prolonged exposure. Part of the furniture structure may not have these properties.



## PEFC agréé

Par notre engagement avec l'environnement nous avons obtenu le certificat PEFC.

Thanks to our environmental commitment, we have obtained the PEFC certificate.





# Compléments

## Porte-serviettes Towel rail

### Porte-serviettes laterale Lateral towel rail

Finition	Référence
● chrome	416 00 001
● noir	416 02 001
○ blanc	416 27 001

Non compatible avec les modèles Sigma et Toscana.

Not compatible with Sigma and Toscana models.

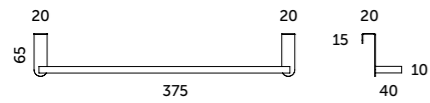

## Pieds Legs / Piedini / Füsse / Poten / أرجل

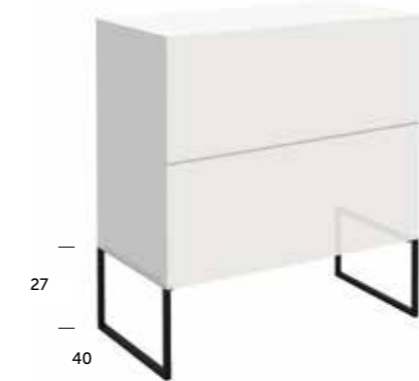

### Pieds Kuadro Kuadro Legs

Finition	Référence
Hauteur 27 cm. Pour meuble 59 cm de hauteur	
● noir	412 02 720
● aluminium	412 00 720



### Kit Industrial

Deux grands pieds, une avec un porte-serviettes.  
2 poignées incluses. Réversible.  
Two tall legs, one with a towel rail.  
2 handles included. Reversible.

Référence
Pour meuble 59 cm de hauteur 412 02 710

Référence
Pour meuble 48 cm de hauteur 412 02 715

## Siphon Siphon / Sifoni / Siphons / Traps / سيفونات

### Siphon chrome Chrome siphon

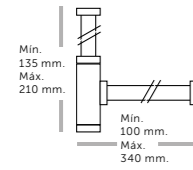

Référence  
410 00 101

## Siphon gain de place Space saving siphon



### Siphon Modèle gain de place

Siphon 1 1/4-32 mm +  
Plafond + Joint réducteur  
32/40 mm

Référence  
410 01 000

## Bonde Valves / Valvole / Ventile / Clickwaste / صبايات

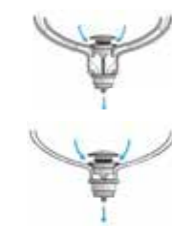

### Soupape universel CLIC CLAC Universal CLIC CLAC valve

Référence  
410 00 203

Adaptable pour plan  
vasque avec trop-plein  
Adaptable for  
countertop without  
overflow

Adaptable pour plan  
vasque sans trop-plein  
Adaptable for  
countertop with  
overflow



### Blonde blanche clic clac White valve

Référence  
410 01 203



### Blonde noir clic clac Black valve

Référence  
410 02 203



### Blonde sans trop-plein Valve without overflow

Référence  
410 00 202

Recommandé pour plan vasque en verre.  
Recommended for glass countertop.

## Supports muraux Wall brackets



Pour plan vasque en verre /  
For glass countertop Set  
44x13 cm

Référence  
410 00 001

## barre de renfort en aluminium aluminum reinforcement bar

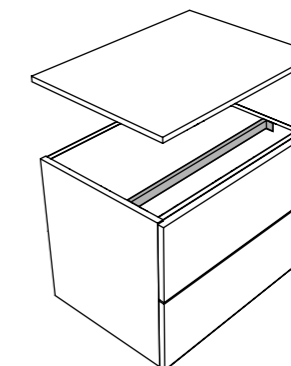

Recommandé pour  
empêcher le plateau de se  
déformer.  
Recommended to prevent  
the top from deforming.

cm	Référence
60	425 14 060
70	425 14 070
80	425 14 080
90	425 14 090
100	425 14 100
120	425 14 120

# Finitions

## Laquéé mate

Réf: (27)

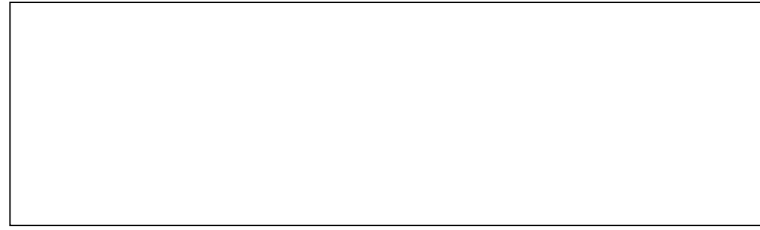

Blanc mat  
Matte white  
Bianco opaco  
Weiß matt  
Mat wit  
أبيض مت

sigma / omega / berlin / toscana / oslo

## Laquéé tres brillant

Réf: (01)

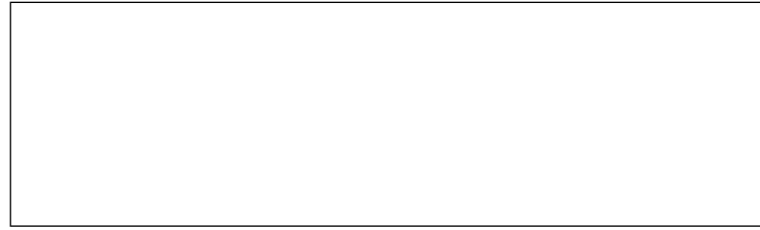

Blanc brillant  
Glossy white  
Bianco lucido  
Weiss hochglanz  
Witte glans  
أبيض لميخ لكر

lúxor / omega / praga / galsaky / galsaky ind / cervino / escorpio / comet / berna / siena / versa / oslo  
joker auxiliaires / cairo colonne

## Melaminé structuré

Réf: (24)



Chêne naturel  
Natural oak  
Rovere naturale  
Natureiche  
Natureel eiken  
بلوط طبيعي

landes / sigma / berlin / lúxor / flow / toscana / oslo / praga / hole / galsaky / galsaky ind / cervino / escorpio / comet / berna / siena / versa / joker auxiliaires / cairo colonne

## Melaminé

Réf: (35)

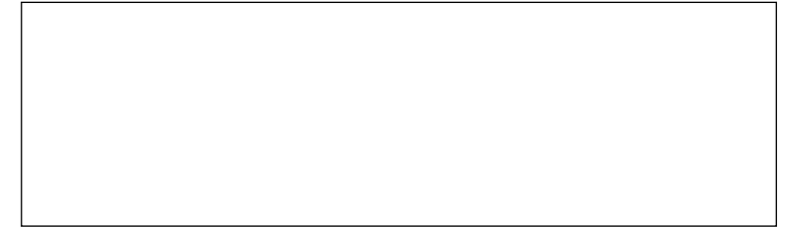

Blanc mat  
Matte white  
Bianco opaco  
Weiß matt  
Mat wit  
أبيض مت

landes

Réf: (46)



Beige gris mat  
Matte Mink  
Tortora opaco  
Graubeige matt  
Mat neris  
ماتي المنك

omega

Réf: (16)



Beige gris brillant  
Glossy Mink  
Tortora lucido  
Graubeige hochglanz  
Nerts glans  
مينك لكر

omega

Réf: (37)



Pin gris  
Grey pine  
Pino-grigio  
Kiefer grau  
Grijs pijn  
سرو رمادي

landes / berlin / lúxor / flow / toscana / oslo / praga / hole / galsaky / galsaky ind / cervino / escorpio / joker auxiliaires / cairo colonne

Réf: (45)



Anthracite mat  
Matte Anthracite  
Antracite opaco  
Antrazit matt  
Mat antracit  
مات أنتراسيت

landes

Réf: (34)



Gris intense mat  
Matte dark grey  
Grigio intenso opaco  
Grau intensiv matt  
Intens mat grijs  
رمادي مت غامق

sigma / omega

Réf: (03)



Gris brillant  
Glossy grey  
Grigio lucido  
Grau hochglanz  
Grijs glans  
رمادي لميخ لكر

omega / galsaky / galsaky ind / joker auxiliaires

Réf: (39)



Noyer  
Dark walnut  
Noce  
Walnuss  
Walnoot  
خشبي جوزي

lúxor / galsaky / galsaky ind / joker auxiliaires / cairo colonne

Réf: (28)



Mint mat  
نمناع

landes

Réf: (18)



Deep blue

toscana

Réf: (44)



Wenge nature  
بني غامق طبيعي

berlin / oslo / praga / cervino / escorpio / joker auxiliaires / cairo colonne

Réf: (29)



Dark forest mat  
غاية مظلمة

landes

Les couleurs imprimées présentées ne sont qu'indicatives et peuvent varier par rapport aux couleurs originales et les receveurs.

Printed colours are approximate and may vary from originals.

I colori stampati sono indicativi e possono variare dall'originale.

Die gedruckten Farben können in Abhängigkeit von der hier dargestellten Papier – Qualität vom Original abweichen.

Kleuren zijn bij benadering en kunnen zeer van originelen

الألوان المطبوعة هي ألوان ارشادية و ممكن أن تكون مختلفة عن الأصلية



# CONDITIONS GENERALES DE VENTE ET DE SERVICES

**ARTICLE 1 – ADHESION AUX CONDITIONS GENERALES DE VENTE ET DE SERVICES :**

Une commande n’est considérée valable qu’après acceptation de ALGICOCINA, toute modification de commande devra être faite obligatoirement par écrit.

Toute commande ferme et acceptée par ALGICOCINA implique pour l’acheteur l’adhésion aux présentes Conditions générales de Vente, et ce quelles que soient les clauses pouvant figurer sur les documents de l’acheteur.

Les Conditions Particulières qui peuvent éventuellement déroger aux présentes Conditions Générales de Vente et de services ne sont opposables à ALGICOCINA que si elles ont été expressément acceptées par écrit par celui-ci.

Pour tout nouveau client, un relevé d’identité bancaire ainsi qu’une fiche d’ouverture de compte dûment remplie et signée outre tous documents d’usage devront être préalablement adressés à ALGICOCINA. Aucune commande ne sera prise en considération avant l’obtention de ces documents.

**ARTICLE 2– :**

Les produits sont facturés au indiqués selon les tarifs en vigueur établis par ALGICOCINA et disponibles sur ses documents commerciaux.

Les sont indiqués en euros et s’entendent hors taxes. Toutes indications portées sur ce catalogue et tarifs ne sont donnés qu’à titre indicatif et peuvent être modifiés à tout moment sans préavis de notre part.

L’éco-participation est mentionnée à titre indicatif et HT. Elle ne peut pas être remise.

**ARTICLE 3 – FRAIS DE PORT**

Pour toute commande égale ou supérieure à 400 € hors taxes ou d’au moins une composition de meuble, l’acheteur bénéficie du franco de port. Une composition se définit par au moins: un meuble bas, et un plan vasque.

Pour toute commande inférieure à 400 € hors taxes, une participation au frais de port de 53,00 € sera facturée à l’acheteur.

**ARTICLE 4 - LIVRAISON, RECEPTION, DELAIS, RETOUR :**

4-1 - Les marchandises sont vendues prises aux entrepôts de ALGICOCINA et voyagent aux risques et périls de l’acheteur, même en cas d’expédition en franco de port.

4-2 - Il incombe à l’acheteur de vérifier les expéditions à l’arrivée, de ne donner décharge datée au transporteur qu’après s’être assuré que les marchandises lui ont été livrées dans les délais normaux et en bon état.

4-3 - Les délais de livraison ne sont donnés qu’à titre informatif et indicatif; ceux-ci dépendant notamment de la disponibilité des transporteurs et de l’ordre d’arrivée des commandes.

Un retard de livraison ne peut ni engager la responsabilité de ALGICOCINA, ni être prétexte à retenue de paiement, obtention de pénalités et/ou de dommages-intérêts.

4-4 - En cas d’avarie ou de perte il incombe à l’acheteur d’effectuer toutes les réserves qui s’imposent. Les réserves devront être portées sur le titre de transport (lettre de voiture, C.M.R, connaissance maritime ou lettre de transport aérien…) dès réception des marchandises et contresignées par le transporteur ou son représentant.

A défaut l’acheteur ne pourra se prévaloir d’aucune réserve ou réclamation.

En tout état de cause, toute réclamation pour être valable devra être confirmée par lettre recommandée avec accusé de réception, dans les 48 heures de la réception de la marchandise. L’existence de réserves ne suspend pas le délai de paiement.

Aucune pénalité financière, pour manquant ou retard de livraison, ne sera acceptée par ALGICOCINA, en l’absence d’accord préalable et écrit.

Aucun retour de marchandises ne pourra être effectué par l’acheteur sans l’accord préalable exprés, écrit de ALGICOCINA, obtenu notamment par télécopie ou courrier électronique

Les frais de retour ne seront à la charge de ALGICOCINA que dans le cas où un vice apparent, ou des manquants, sont effectivement constatés par ALGICOCINA ou son mandataire.

Seul le transporteur choisi par ALGICOCINA est habilité à effectuer le retour des produits concernés.

**ARTICLE 5 – RESPONSABILITE :**

5-1 – Force Majeure :

ALGICOCINA n’est pas responsable d’un défaut d’exécution dans ses obligations notamment au titre des retards ou des impossibilités de livrer lorsque cela est imputable à un cas de force majeure. De façon expresse seront considérés comme cas de Force majeure, outre ceux retenus par la jurisprudence française, les retards ou interruption dans les transports pour quelques raisons que ce soit, l’indisponibilité ou la pénurie de matière, la mise en liquidation judiciaire de l’un de ses fournisseurs ou sous-traitants, le blocage ou la perturbation des moyens de communications, de télécommunications ou postaux, incendie, inondation, grève e ou partielle, accident de l’outillage, nouvelles exigences réglementaires ou douanières.

5-2 – Responsabilité liée aux produits :

Algicocina décline toute responsabilité sur les produits en cas de non-respect par le client des conditions de stockage ou d’utilisation du produit définies par la réglementation en vigueur et/ ou répondant aux préconisations de ALGICOCINA.

D'une façon générale si la défectuosité du produit est la conséquence d'un fait imputable à l'acheteur, ses préposés, mandataires, prestataires ou sous-traitants, ALGICOCINA décline toute responsabilité.

5-3 – Recommandations d’usage et d’entretien

Ne pas stocker ou exposer le meuble directement au soleil. Ne pas stocker ou exposer le meuble directement au contact de liquides.

Nettoyer le meuble avec un chiffon ou une éponge légèrement humide. Ne pas utiliser de produits abrasifs. Ne pas utiliser de détergents.

**ARTICLE 6 - CONDITIONS DE REGLEMENT :**

Le règlement de factures par l’acheteur à ALGICOCINA doit être effectué par virement bancaire au nom de ALGICOCINA ou par LCR sans aceptation.

Le convenu pour une vente s’entend toujours pour un règlement effectué dans les délais de Référence définis ci-dessous.

6-1 - Délais de paiement:

Le paiement est au choix de l’acheteur, qui doit le préciser au moment de la commande :

- soit à 60 jours nets date d’émission de la facture,

- soit à 45 jours fin de mois suivant la date d’émission de la facture.

Pour les règlements anticipés, soit 40 jours net maximum avant la date d’échéance, un escompte de 1 % est consenti.

Toutefois, dans le cadre de la gestion du risque client, ALGICOCINA se réserve le droit en fonction de la situation de l’acheteur ou en cas de retards de règlement répétés, d’exiger un règlement anticipé ou de suspendre voire même de refuser les livraisons.

6-2 - Paiement, retard ou défaut :

6-2-1 - En cas de retard ou défaut de paiement, ALGICOCINA sera en droit de suspendre toutes les commandes en cours et de refuser toute nouvelle commande, sans préjudice de toute autre voie d’action.

6-2-2 - Toute somme non réglée à l’échéance figurant sur la facture donnera lieu de plein droit au paiement d’intérêts de retard à un taux égal au taux d’intérêt appliqué par la Banque centrale européenne à son opération de refinancement la plus récente, majoré de 10 points de pourcentage. Ces intérêts sont calculés et exigibles à compter du jour suivant l’échéance définie dans la facture. Tous les frais exposés pour le recouvrement de sa créance par ALGICOCINA seront à la charge définitive de l’acheteur. Toute facturation correspondante aux intérêts de retard ne saurait être inférieure à la somme de 150€ HT.

6-2-3 - Le non-paiement d’une échéance rend immédiatement exigible toutes les autres créances de ALGICOCINA sur l’acheteur.

6-2-4- En cas d’absence de paiement à échéance, ALGICOCINA sera en droit de revendiquer les marchandises restées en stock chez l’acheteur qui demeure la propriété ALGICOCINA en application de l’article 7 « clause de réserve de propriété ».

6-2-5- En sus des intérêts de retard ci-avant stipulés, il sera appliqué à titre de sanction pour non-paiement à échéance, une indemnité forfaitaire de 15%. Cette Pénalité sera appliquée à la ité des sommes dues et non réglées y compris les montants rendus exigibles en application du paragraphe 6-2-3.

6-2-6– L’ensemble des sommes dues en cas de retard ou de défaut de paiement pourront être déduites des créances de l’acheteur.

6-2-7 - En aucun cas les paiements ne peuvent être suspendus ni faire l’objet d’une quelconque compensation sans l’accord préalable de ALGICOCINA.

**ARTICLE 7 - CLAUSE DE RESERVE DE PROPRIETE:**

Le transfert de propriété des marchandises est subordonné au paiement intégral de leur par l’acheteur.

Dès la livraison desdites marchandises, l’acquéreur en deviendra gardien et devra répondre de toute détérioration ou disparition.

Les marchandises livrées par ALGICOCINA, en stock chez l’acheteur seront présumées faire partie des choses impayées. L’acheteur ne pourra en aucun cas nantir ou consentir de sûreté sur ces stocks impayés.

L’acheteur pourra revendre les marchandises dans le cadre de l’exploitation normale de son entreprise. Toutefois, il perdra cette faculté en cas de cessation des paiements ou de non-paiement du à l’échéance.

**ARTICLE 9– CLAUSE INTUITUS PERSONAE :**

L’acheteur s’interdit par quelques moyens que ce soit toute transmission, cession ou transfert des contrats conclus avec ALGICOCINA faisant application des présentes conditions générales de vente sans l’approbation écrite et préalable de ce dernier.

**ARTICLE 10 – DROIT APPLICABLE – COMPETENCE - CONTESTATION:**

Les présentes conditions sont soumises au droit espagnol, seul ce dernier s’applique à la relation commerciale que ALGICOCINA et l’acheteur établissent et aux ventes qui en résultent. Tout diffèrent sera donc réglé en application du droit espagnol et relève de la compétence exclusive des tribunaux de Valencia, même en cas de diffèrent sur la validité même du contrat. Il est expressément précisé que la Convention de Vienne sur la vente internationale de marchandise n’est pas applicable aux présentes.

ALGICOCINA S.L. en tant que propriétaire de la marque ALGICOCINA se réserve le droit de modifier ou d’annuler toute information apparaissant dans ce catalogue.

La reproduction partielle ou e de ce catalogue est strictement interdite. Images protégées.

Design du produit: Coycama. Tous droits réservés.

ALGICOCINA tient à remercier tous ses fournisseurs et tous ses clients pour la confiance qu’ils lui accordent.

coycama



# único

meubles  
de salle  
de bain

## **Coycama France**

### **Cap Sanitaire**

Chemin Giroud  
38110 Saint Victor de Cessieu  
Tél.: +33 474 33 86 27  
Fax: +33 474 33 53 10  
commandes@cap-sanitaire.com

[coycama.com](http://coycama.com)

## **Coycama Europe**

Pol. Industrial Valldepins  
43550 Ulldecona - SPAIN  
Tel. +34 977 72 01 19  
Tel. +34 977 72 02 77  
export@coycama.com

**coycama**